

PASSION doesn't come from a can. It's not in aisle 6 of the local mega-mart. And you can't order it from some late night infomercial. It comes from deep inside those who truly love to ride.

It's in this **PASSION** we created the **FOUR CORNERSTONES** of a great riding experience.

So for those who want stables of galloping horsepower. Or to hear the crack of a sonic boom. Or to blast through a mountain cornice. Or to just cruise in the lap of luxury. Whatever it is, we've got it.



From the World's Fastest Snowmobiles™ to Industry-Leading Horsepower. From Expert-Grade Mountain sleds to our Body-Saving Ride technology – only Arctic Cat gives you the ultimate riding experience.

ARCTIC CAT. SHARE OUR PASSION.™

VISIT THE ARCTIC CAT WEBSITE AT WWW.ARCTICCAT.COM

ALL SPECIFICATIONS, CLAIMS, PRICES AND INFORMATION CONTAINED WITHIN ARE BASED UPON CURRENT KNOWLEDGE AS OF FEBRUARY 1, 2010, AND ARE SUBJECT TO CHANGE WITHOUT NOTICE. PRICES DO NOT INCLUDE FREIGHT, HANDLING OR SETUP CHARGES. ARAMAX® IS A TRADEMARK OF CARLISLE POWER TRANSMISSION PRODUCTS, INC. CHALLENGER,™ COBRA,™ HACKSAW,™ ICE CLAW,™ ICE RIPPER,™ AND RIPSAW™ ARE TRADEMARKS OF CAMOPLAST INC. CLARINO™ IS A TRADEMARK OF THE KURARAY COMPANY. CTEK® IS A TRADEMARK OF CTEK POWER, INC. DEUCE,™ POWER PLATE,™ POWER PLATE PLUS,™ POWER POINT,™ POWER POINT PLUS,™ SHAPER,™ STUD BOY,® AND SUPER-LITE PLUS™ ARE TRADEMARKS OF LIBERTY PRODUCTS INC. EVOL,™ FOX® AND FOX FLOAT® AIRSHOX™ ARE TRADEMARKS OF FOX RACING SHOES. FLOAT 30,™ TRACKER DTS™ AND TRACKER2™ ARE TRADEMARKS OF BACKCOUNTRY ACCESS, INC. LEXAN® IS A TRADEMARK OF GENERAL ELECTRIC COMPANY. KEVLAR,® LYCRA,® TEFLON,® AND THERMOLITE® ARE TRADEMARKS OF E.I. DU PONT DE NEMOURS AND COMPANY. NO-FOG® IS A TRADEMARK OF MST CORPORATION. OGIO® IS A TRADEMARK OF OGIO INTERNATIONAL. POWDER PRO SKIS™ IS A TRADEMARK OF STARTING LINE PRODUCTS, INC. REALTREE® IS A TRADEMARK OF JORDAN OUTDOOR ENTERPRISES, LTD. SMITH® IS A TRADEMARK OF SMITH SPORT OPTICS, INC. SURLAST™ IS A TRADEMARK OF SURLAST, LLC. 3M™ SCOTCHLITE™ AND THINSULATE™ ARE TRADEMARKS OF 3M COMPANY. TEK RIDER™ IS A TRADEMARK OF TEK RIDER. VELCRO® IS A TRADEMARK OF SCOTCHMATE INC. WARN® IS A TRADEMARK OF WARN INDUSTRIES, INC. WOODY'S,® DOOLY,™ DOUBLE DIGGER,™ GOLD DIGGER,® GRAND MASTER,™ SIGNATURE SERIES,™ AND TRACTION MASTER® ARE TRADEMARKS OF INTERNATIONAL ENGINEERING AND MANUFACTURING, INC. YUASA® IS A TRADEMARK OF YUASA BATTERY, INC. ZYLEX® IS A TRADEMARK OF KAMIK®, WHICH IS A DIVISION OF GENFOOT INC. ACT,™ ADVANTAGE,® APV,™ ARCTIC CAT,® ARCTIC POWER VALVE,™ ARCTICWEAR,® A-TEX,™ BEARCAT,® BOSS CAT,™ CAT,™ CAT COMM,™ CAT'S PRIDE,™ CAT'S PRIDE CLUB,™ CAT TRACKER,™ CROSSFIRE,™ F SERIES,™ FASHION FIT,™ POWER CLAW,™ SHARE OUR PASSION,™ SNO CROSS,® SNO-LOCK,™ SNO PRO,® TEAM ARCTIC,® TOM CAT,™ WORLD'S FASTEST SNOWMOBILES,™ AND ZI™ ARE ALL TRADEMARKS OF ARCTIC CAT INC., THIEF RIVER FALLS, MN. ©2010 ARCTIC CAT SALES INC. PRINTED IN U.S.A.

Arctic Cat Sales Inc.
601 Brooks Avenue South
Thief River Falls, MN 56701

5214-005 US
PGA90165

| | | |
|--|--|--|
| <p>LES MODÈLES ONT ÉTÉ ÉVALUÉS PAR UN LABORATOIRE D'ESSAIS INDÉPENDANT ET SATISFAIENT TOUTES LES NORMES DE SÉCURITÉ DU SSCC EN VIGUEUR À LA DATE DE FABRICATION.</p> <p>PARRAINÉ PAR LE COMITÉ DE SÉCURITÉ ET DE CERTIFICATION DE LA MOTONEIGE, INC.</p> | <p>CERTIFIED</p> <p>CERTIFIÉ</p> | <p>ALL ARCTIC CAT MODELS HAVE BEEN EVALUATED BY AN INDEPENDENT TESTING LABORATORY AND MEET ALL SSCC SAFETY STANDARDS IN EFFECT ON THE DATE OF MANUFACTURE.</p> <p>SPONSORED BY THE SNOWMOBILE SAFETY AND CERTIFICATION COMMITTEE, INC.</p> |
|--|--|--|

GET APPROVAL IN MINUTES FOR THE THINGS YOU WANT. ASK YOUR DEALER FOR AN APPLICATION!



SNOWMOBILING IS SERIOUS FUN. BE SURE TO READ AND UNDERSTAND YOUR OWNER'S MANUAL AND PLEASE PAY SPECIAL ATTENTION TO THE SAFETY INSTRUCTIONS. ARCTIC CAT, INC. ENDORSES AND ENCOURAGES THE SAFE USE OF ALL SNOWMOBILES. BE CAREFUL, YOU CAN GET HURT. WEAR A HELMET AND DON'T DRINK AND RIDE. BE AWARE OF NATURAL HAZARDS YOU MAY ENCOUNTER, ALLOW YOURSELF PLENTY OF ROOM TO SAFELY STOP YOUR SNOWMOBILE UNDER ALL CONDITIONS, AND MAINTAIN YOUR EQUIPMENT. YOUR SAFETY IS IN YOUR HANDS, SO TAKE CARE. ALL SCENES DEPICTED OR DESCRIBED IN THIS BROCHURE WERE PERFORMED BY PROFESSIONAL RIDERS UNDER CAREFULLY CONTROLLED CONDITIONS. LEAVE THE FANCY RIDING TO THE PROS; THEY PRACTICE FOR YEARS AND TRAIN VERY HARD TO MAKE IT LOOK EASY. NEVER ATTEMPT TO DUPLICATE THESE MANEUVERS OR ENCOURAGE OTHERS TO DO SO. WE CARE ABOUT YOUR SAFETY AND ENJOYMENT OF THE SPORT. ALL MATERIALS AND SPECIFICATIONS ARE SUBJECT TO CHANGE WITHOUT NOTICE.



2011 ARCTICWEAR & ACCESSORIES

2011 ARCTICWEAR & ACCESSORIES





Trailhead parking-lot laughter. The hum of a throttle-induced acceleration into that white world of awesome. A healthy dose of hooting, hollering and heck yeahs when someone goes big, sticks the line or just climbs off their sled visibly psyched about the ride. That's the stoke of winter where we all call home, where the exact size of the wickedly huge smiles spanning ear-to-ear directly correlates with the amount of snow that's fallen the previous evening.

It also says a lot about our shared passion for the ride and the fantastic places riding takes your mind, body and soul — a powerful reason you'll find the latest clothing designs, fashions and product technologies within these pages. Whether it's to surround you in warm, dry, daylong comfort or help you trick out your sled with gear and accessories that make that sled distinctly yours, our insistence on forever pushing the technology flat-out makes the passion stronger year in, year out.

It's time to ride, friends, because that's what we all do best together.



TOM CAT JACKET (PAGE 17)
SNO PRO PREMIUM COAT (PAGE 5)

JACKETS/COATS: 4-19

MEN'S PANTS: 20-21

WOMEN'S ARCTICWEAR: 22-23

WOMEN'S PANTS: 24-25

YOUTH ARCTICWEAR: 26-31

YOUTH SPORTSWEAR: 32-36

HELMETS: 37-43

GOGGLES: 44

HEADWEAR: 45-49

GLOVES: 50-53

BOOTS: 54-55

GEAR BAGS: 56-57

RIDE ACCESSORIES: 58

SWEATSHIRTS: 60-62

LONG-SLEEVES: 63-64

T-SHIRTS: 65-66

CASUAL/GOLF SHIRTS: 67

PERFORMANCE: 68

JERSEYS: 69-70

WOMEN'S SPORTSWEAR: 71-73

JUNIOR SPORTSWEAR: 74-77

CAPS: 78-79

COLLECTIBLES: 80-81

DECALS: 82

TRUCK ACCESSORIES: 83

ACCESSORIES/PARTS: 84-138

SIZING CHARTS: 139



INCLUDES LINER



Remarkably warm, bulk-free 100 grams Thinsulate™ Insulation - Waterproof, breathable A-Tex™-coated fabric with fully taped seams - Front flap magnetic closure keeps snow out - Added safety from highly visible reflective trim - It's three jackets/coats in one — the included 100-gram zip-out liner provides additional warmth or can be worn as a stand-alone - Rock out with the new, convenient MP3 player pocket with tangle-free neck cord system - Length of coat is 4" longer than jacket

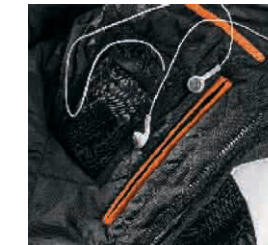

COAT AND JACKET FEATURE MP3 PLAYER-READY POCKET



COAT

MEN'S:
LIME: 5210-20_* ORANGE: 5210-22_*
BLACK: 5210-24_*, -250 3XLT, -251 4XL, -252 5XL

WOMEN'S:
-WOMEN'S LIME & ORANGE AVAILABLE IN S-2XL
-WOMEN'S BLACK AVAILABLE IN S-2XL, 3XL & 4XL

LIME: 5210-21_* ORANGE: 5210-23_*
BLACK: 5210-26_*, -271 4XL

S-XL: \$319.95 XLT-3XLT: \$329.95 4XL-5XL: \$339.95

*ADD CORRESPONDING SIZE NUMBER AT END OF 6-DIGIT PART #.

| SIZE | SIZE P/N | S | M | MT | L | LT | XL | XLT | 2XL | 2XLT | 3XL |
|------|----------|---|---|----|---|----|----|-----|-----|------|-----|
| | | 1 | 2 | 3 | 4 | 5 | 6 | 7 | 8 | 0 | 9 |



JACKET

MEN'S:
LIME: 5210-28_*
BLACK: 5210-30_*, -310 3XLT, -311 4XL, -312 5XL

S-XL: \$309.95 XLT-3XLT: \$319.95 4XL-5XL: \$329.95





INCLUDES LINER

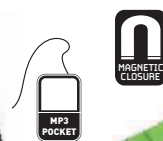

COAT

MEN'S:
GREEN: 5210-35_* BLACK: 5210-37_*

WOMEN'S:
-WOMEN'S AVAILABLE IN S-2XL

GREEN: 5210-36_* BLACK: 5210-38_*

S-XL: \$319.95 XLT-3XL: \$329.95

*ADD CORRESPONDING SIZE NUMBER AT END OF 6-DIGIT PART #.

| SIZE | SIZE P/N | S | M | MT | L | LT | XL | XLT | 2XL | 2XLT | 3XL |
|------|----------|---|---|----|---|----|----|-----|-----|------|-----|
| | | 1 | 2 | 3 | 4 | 5 | 6 | 7 | 8 | 0 | 9 |



COAT AND JACKET FEATURE MP3 PLAYER-READY POCKET



JACKET

MEN'S:
GREEN: 5210-39_* ORANGE: 5210-43_*
BLACK: 5210-41_*

S-XL: \$309.95 XLT-3XL: \$319.95

Remarkably warm, bulk-free 100 grams Thinsulate™ Insulation - Waterproof, breathable A-Tex-coated fabric with fully taped seams
- Front flap magnetic closure keeps snow out - Added safety from highly visible reflective trim - It's three jackets/coats in one — the included 100-gram zip-out liner provides additional warmth or can be worn as a stand-alone - Hidden magnets secure collar and eliminate wind flutter - Rock out with the new, convenient MP3 player pocket with tangle-free neck cord system
- Length of coat is 4" longer than jacket





Start warm, end warm. That's the mantra behind our phenomenally versatile Flex Liner System. With four different variations of heat — 100 or 200 grams Thinsulate™ Insulation, Fleece or Softshell — you can choose your personal level of warmth, comfort and wind protection, then seamlessly zip it into Arctic Cat® Flex System coats and jackets for an extra layer of cold-weather protection. As a bonus, the Flex Zip-Out Liners double as great light spring or fall jackets.

*ADD CORRESPONDING SIZE NUMBER AT END OF 6-DIGIT PART #.

| SIZE | SIZE | S | M | MT | L | LT | XL | XLT | 2XL | 2XLT | 3XL |
|------|------|---|---|----|---|----|----|-----|-----|------|-----|
| P/N | | 1 | 2 | 3 | 4 | 5 | 6 | 7 | 8 | 0 | 9 |



TECH 100 GRAM NYLON ZIP-OUT

- WARM, BULK-FREE 100 GRAMS THINSULATE™ INSULATION
- IDEAL AS A SPRING/FALL JACKET
- QUICKLY ZIPS INTO ALL FLEX SYSTEM JACKETS AND COATS

MEN'S:

BLACK: 5200-91_*, -920 3XLT, -921 4XL, -922 5XL
 GREEN: 5200-99_*, 5201-000 3XLT, 5201-001 4XL, 5201-002 5XL
 ORANGE: 5200-95_*, -960 3XLT, -961 4XL, -962 5XL

WOMEN'S:

-WOMEN'S AVAILABLE IN S-2XL, 3XL & 4XL

BLACK: 5200-93_*, -940 4XL GREEN: 5201-01_*, 5201-020 4XL
 ORANGE: 5200-97_*, -980 4XL

S-XL: \$89.95 XLT-3XLT: \$99.95 4XL-5XL: \$109.95



200 GRAM NYLON ZIP-OUT

- THE HEIGHT IN WARMTH FROM BULK-FREE 200 GRAMS THINSULATE™ INSULATION
- IDEAL AS A SPRING/FALL JACKET
- QUICKLY ZIPS INTO ALL FLEX SYSTEM JACKETS AND COATS

MEN'S:

5201-03_*, -040 3XLT, -041 4XL, -042 5XL

WOMEN'S:

-WOMEN'S AVAILABLE IN S-2XL, 3XL & 4XL

5201-05_*, -060 4XL

S-XL: \$99.95
 XLT-3XLT: \$109.95
 4XL-5XL: \$119.95



SOFTSHELL ZIP-OUT

- OFFERS UNRESTRICTED MOVEMENT FROM WARM, STRETCHABLE POLYESTER/SPANDEX FABRIC
- IDEAL AS A SPRING/FALL JACKET
- QUICKLY ZIPS INTO ALL FLEX SYSTEM JACKETS AND COATS

MEN'S:

5201-11_*, -120 3XLT, -121 4XL, -122 5XL

WOMEN'S:

-WOMEN'S AVAILABLE IN S-2XL, 3XL & 4XL

5201-13_*, -140 4XL

S-XL: \$99.95
 XLT-3XLT: \$109.95
 4XL-5XL: \$119.95



FLEECE ZIP-OUT

- NON-PILL FLEECE OFFERS A LIGHT, THERMAL BARRIER
- IDEAL FOR MORE AGGRESSIVE RIDERS
- QUICKLY ZIPS INTO ALL FLEX SYSTEM JACKETS AND COATS

MEN'S:

5201-07_*, -080 3XLT, -081 4XL, -082 5XL

WOMEN'S:

-WOMEN'S AVAILABLE IN S-2XL, 3XL & 4XL

5201-09_*, -100 4XL

S-XL: \$69.95
 XLT-3XLT: \$79.95
 4XL-5XL: \$89.95



Remarkably warm, bulk-free 100 grams Thinsulate™ Insulation - Waterproof, breathable A-Tex-coated fabric with fully taped seams - Front flap magnetic closure keeps snow out - Length of coat is 4" longer than jacket



COAT

MEN'S:
 BLACK: 5201-50_*, -510 3XLT, -511 4XL, -512 5XL
 LIME/BLACK: 5201-40_*, -410 4XL, -411 5XL ORANGE: 5210-07_*

WOMEN'S:
 -WOMEN'S ORANGE & PINK AVAILABLE IN S-2XL
 -WOMEN'S LIME/BLACK & BLACK AVAILABLE IN S-2XL, 3XL & 4XL

BLACK: 5210-09_*, -099 3XL, -100 4XL PINK: 5201-48_*
 LIME/BLACK: 5201-44_*, -449 3XL, -450 4XL ORANGE: 5210-08_*

S-XL: \$249.95 XLT-3XL: \$259.95 4XL-5XL: \$269.95

TEAM ARCTIC® PANTS

-EXCEPTIONALLY WARM, BULK-FREE 200 GRAMS THINSULATE™ INSULATION
 -ADJUSTABLE, REMOVABLE SUSPENDERS EASILY ZIP OFF TO CONVERT INTO WAIST-HIGH PANTS

MEN'S:
 BLACK: 5210-11_*, -120 3XLT, -121 4XL, -122 5XL

WOMEN'S:
 BLACK: 5210-13_*, -139 3XL, -141 4XL PINK: 5201-49_*(S-2XL)

S-XL: \$209.95 XLT-3XL: \$219.95 4XL-5XL: \$229.95

*ADD CORRESPONDING SIZE NUMBER AT END OF 6-DIGIT PART #.

| SIZE | SIZE P/N | S | M | MT | L | LT | XL | XLT | 2XL | 2XLT | 3XL |
|------|----------|---|---|----|---|----|----|-----|-----|------|-----|
| | | 1 | 2 | 3 | 4 | 5 | 6 | 7 | 8 | 0 | 9 |



JACKET FEATURES MP3 PLAYER-READY POCKET



JACKET

MEN'S:
 LIME: 5210-15_* Black: 5210-16_*
 S-XL: \$239.95 XLT-3XL: \$249.95

*ADD CORRESPONDING SIZE NUMBER AT END OF 6-DIGIT PART #.

| SIZE | SIZE P/N | S | M | MT | L | LT | XL | XLT | 2XL | 2XLT | 3XL |
|------|----------|---|---|----|---|----|----|-----|-----|------|-----|
| | | 1 | 2 | 3 | 4 | 5 | 6 | 7 | 8 | 0 | 9 |

- Remarkably warm, bulk-free 100 grams Thinsulate™ Insulation - Waterproof, breathable A-Tex-coated fabric with fully taped seams
- Front flap magnetic closure keeps snow out - Rock out with the new, convenient MP3 player pocket with tangle-free neck cord system - Jacket features hidden magnets that secure collar and is complete with race team sponsor logos

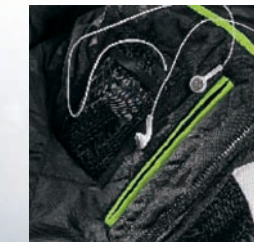

JACKET FEATURES MP3 PLAYER-READY POCKET



REBEL JACKET

- REMARKABLY WARM, BULK-FREE 100 GRAMS THINSULATE™ INSULATION
- WATERPROOF, BREATHABLE, A-TEX-COATED FABRIC WITH FULLY TAPED SEAMS
- ROCK OUT WITH THE NEW, CONVENIENT MP3 PLAYER POCKET WITH TANGLE-FREE NECK CORD SYSTEM

MEN'S:
 BLACK: 5210-17_* LIME: 5210-65_*

S-XL: \$239.95 XLT-3XL: \$249.95



*ADD CORRESPONDING SIZE NUMBER AT END OF 6-DIGIT PART #.

| SIZE | SIZE P/N | S | M | MT | L | LT | XL | XLT | 2XL | 2XLT | 3XL |
|------|----------|---|---|----|---|----|----|-----|-----|------|-----|
| | | 1 | 2 | 3 | 4 | 5 | 6 | 7 | 8 | 0 | 9 |



SNO CROSS® SUIT

- MESH LINING WITH UNDERARM AND BACK VENTS PROVIDES AMPLE AIRFLOW AND BREATHABILITY
- WATERPROOF, BREATHABLE, A-TEX-COATED FABRIC WITH FULLY TAPED SEAMS
- AN EXACT RACE TEAM REPLIC TO SHOW OFF YOUR TEAM PRIDE
- ADJUSTABLE, REMOVABLE SUSPENDERS EASILY ZIP OFF TO CONVERT INTO WAIST-HIGH PANTS

JACKET:

MEN'S:
5210-18_*

S-XL: \$199.95 XLT-3XL: \$209.95

PANTS:

MEN'S:
5210-19_*

S-XL: \$179.95 XLT-3XL: \$189.95

*ADD CORRESPONDING SIZE NUMBER AT END OF 6-DIGIT PART #.

| SIZE | SIZE P/N | S | M | MT | L | LT | XL | XLT | 2XL | 2XLT | 3XL |
|------|----------|---|---|----|---|----|----|-----|-----|------|-----|
| | P/N | 1 | 2 | 3 | 4 | 5 | 6 | 7 | 8 | 0 | 9 |



BACKCOUNTRY PULLOVER

- LIGHTWEIGHT, MOISTURE-WICKING MESH LINING
- LOADS OF STORAGE ROOM FROM MULTIPLE POCKETS
- WATERPROOF, BREATHABLE 2-LAYER FABRIC WITH FULLY TAPED SEAMS
- ADDED AIRFLOW FROM ZIPPERED CHEST, ARM AND BACK VENTING



MEN'S:
5210-45_*

S-XL: \$169.95 XLT-3XL: \$179.95

*ADD CORRESPONDING SIZE NUMBER AT END OF 6-DIGIT PART #.

| SIZE | SIZE P/N | S | M | MT | L | LT | XL | XLT | 2XL | 2XLT | 3XL |
|------|----------|---|---|----|---|----|----|-----|-----|------|-----|
| | P/N | 1 | 2 | 3 | 4 | 5 | 6 | 7 | 8 | 0 | 9 |



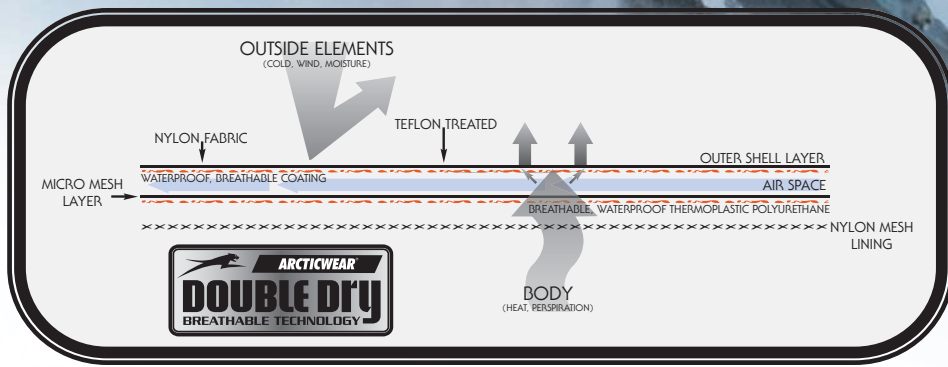

3M Scotchlite[™]
Reflective Material

Durable, waterproof, breathable, Teflon[®]-treated nylon outer shell - Highly breathable micro-mesh-technology inner lining - Nylon mesh lining allows inside heat to move away from your body - Added airflow from zippered chest and back venting - Front flap magnetic closure keeps snow out - Rock out with the new, convenient MP3 player pocket with tangle-free neck cord system - Length of coat is 4" longer than jacket

COAT AND JACKET FEATURE
MP3 PLAYER-READY POCKET

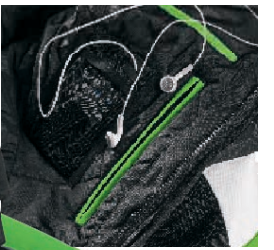

JACKET

MEN'S:
GREEN: 5210-49_* ORANGE: 5210-51_*
BLACK: 5210-50_*

S-XL: \$239.95 XLT-3XL: \$249.95

*ADD CORRESPONDING SIZE NUMBER AT END OF 6-DIGIT PART #.

| SIZE | SIZE P/N | S | M | MT | L | LT | XL | XLT | 2XL | 2XLT | 3XL |
|------|----------|---|---|----|---|----|----|-----|-----|------|-----|
| | | 1 | 2 | 3 | 4 | 5 | 6 | 7 | 8 | 0 | 9 |



COAT

MEN'S:
GREEN: 5210-46_* ORANGE: 5210-48_*
BLACK: 5210-47_*

S-XL: \$249.95 XLT-3XL: \$259.95



Ultrawarm, bulk-free 200 grams **Thinsulate™** Insulation - Front flap magnetic closure keeps snow out while hidden magnets secure collar - Rock out with the new, convenient MP3 player pocket with tangle-free neck cord system - Added safety from highly visible reflective trim - Length of coat is 4" longer than jacket

Thinsulate
INSULATION



COAT

MEN'S:
LIME: 5210-03_* BLACK: 5210-05_*

WOMEN'S:
-WOMEN'S AVAILABLE IN S-2XL

LIME: 5210-04_* BLACK: 5210-06_*

S-XL: \$179.95 XLT-3XL: \$189.95

*ADD CORRESPONDING SIZE NUMBER AT END OF 6-DIGIT PART #.

| SIZE | SIZE P/N | S | M | MT | L | LT | XL | XLT | 2XL | 2XLT | 3XL |
|------|----------|---|---|----|---|----|----|-----|-----|------|-----|
| | | 1 | 2 | 3 | 4 | 5 | 6 | 7 | 8 | 0 | 9 |

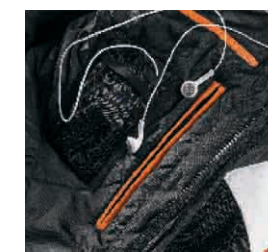

COAT AND JACKET FEATURE MP3 PLAYER-READY POCKET



JACKET

MEN'S:
ORANGE: 5210-02_* LIME: 5210-00_*
BLACK: 5210-01_*

S-XL: \$169.95 XLT-3XL: \$179.95



A. PREMIUM BIBS (SHOWN ON PAGE 20)

- WATERPROOF, BREATHABLE, A-TEX-COATED FABRIC WITH FULLY TAPED SEAMS
- ULTRAWARM, BULK-FREE 200 GRAMS THINSULATE™ INSULATION
- EXTRA-PROTECTIVE FULL BIB TOP

5200-75_*, -760 3XLT, -761 4XL, -762 5XL

S-XL: \$199.95 XLT-3XLT: \$209.95
4XL-5XL: \$219.95

5200-77_* (SHORT-LENGTH INSEAM)

S-XL: \$199.95 2XL-3XL: \$209.95

B. BOSS CAT™ PANTS (SHOWN ON PAGE 20)

- WATERPROOF, BREATHABLE, A-TEX-COATED FABRIC WITH FULLY TAPED SEAMS
- ULTRAWARM, BULK-FREE 200 GRAMS THINSULATE™ INSULATION
- UNIQUE HIGH-BACK BIB PREVENTS SNOW AND COLD FROM ENTERING PANTS
- ADJUSTABLE, REMOVABLE SUSPENDERS EASILY ZIP OFF TO CONVERT INTO WAIST-HIGH PANTS

5200-80_*

S-XL: \$199.95 XLT-3XL: \$209.95



STEALTH PANTS

- WARM, BULK-FREE 200 GRAMS THINSULATE™ FLEX INSULATION IN SEAT AND HIPS
- 150 GRAMS THINSULATE™ FLEX INSULATION IN THIGHS/LEGS
- STRETCH FABRIC IN SEAT/HIPS PROVIDES A COMFORTABLE FIT

5200-90_*

S-XL: \$179.95
XLT-3XL: \$189.95

SNO PRO® PANTS

- TEFLON-TREATED NYLON OUTER SHELL
- WATERPROOF, BREATHABLE COATING IS SANDWICHED BETWEEN OUTER SHELL AND MICRO-MESH NYLON INNER LINING
- LAMINATED LAYERS FORM A 3-LAYER FABRIC
- HIGH-BACK BIB PREVENTS SNOW AND COLD FROM ENTERING PANTS
- ADJUSTABLE, REMOVABLE SUSPENDERS EASILY ZIP OFF TO CONVERT INTO WAIST-HIGH PANTS

5200-83_*, 5201-170 3XLT, 5201-171 4XL, 5201-172 5XL

S-XL: \$249.95
XLT-3XLT: \$259.95
4XL-5XL: \$269.95

BOONDOCKER BIBS

- DURABLE, TEFLON-TREATED NYLON OUTER SHELL
- WATERPROOF, BREATHABLE COATING IS SANDWICHED BETWEEN OUTER SHELL AND MICRO-MESH NYLON INNER LINING
- LAMINATED LAYERS FORM A WATERPROOF, BREATHABLE 3-LAYER FABRIC
- EXTRA-PROTECTIVE BIB TOP

5200-85_*

S-XL: \$249.95
XLT-3XL: \$259.95

ADVANTAGE® PANTS

- ULTRAWARM, BULK-FREE 200 GRAMS THINSULATE™ INSULATION
- DRY-SEAT INSERT ACTS AS A MOISTURE BARRIER
- SNO-LOCK™ CUFFS KEEP BOOTS SNOW-FREE

5200-73_*

S-XL: \$149.95
XLT-3XL: \$159.95

*ADD CORRESPONDING SIZE NUMBER AT END OF 6-DIGIT PART #.

| SIZE | SIZE P/N | S | M | MT | L | LT | XL | XLT | 2XL | 2XLT | 3XL |
|------|----------|---|---|----|---|----|----|-----|-----|------|-----|
| | | 1 | 2 | 3 | 4 | 5 | 6 | 7 | 8 | 0 | 9 |



Thinsulate
INSULATION

Thinsulate Zone
INSULATION



Newsflash: Flattery will get you surprisingly far, so flattery was priority numero uno when designing the Women's Arcticwear® lineup. Here you'll find styles designed fit a woman's curves, which means those tired, old boxy and overly baggy styles were ignored in favor of designs that hug, accent and heat up in a markedly cool Catgirl way.

Thinsulate
INSULATION



CATGIRL GLAM COAT

- WARM, SUPERSOFT 200 GRAMS THINSULATE™ INSULATION
- ROCK OUT WITH THE NEW, CONVENIENT MP3 PLAYER POCKET WITH TANGLE-FREE NECK CORD SYSTEM
- LONGER STYLE GIVES GREAT COVERAGE AT A GREAT VALUE
- PRINTED FABRIC STANDS APART FROM THE CROWD

5210-64_*

S-XL: \$179.95 XLT-2XL: \$189.95



MATCHING LEOPARD CATGIRL BEANIE, SEE PAGE 46



COATS FEATURE MP3 PLAYER-READY POCKET



CATGIRL ADVANTAGE COAT

- ULTRAWARM, BULK-FREE 200 GRAMS THINSULATE™ INSULATION
- ROCK OUT WITH THE NEW, CONVENIENT MP3 PLAYER POCKET WITH TANGLE-FREE NECK CORD SYSTEM
- LONGER STYLE GIVES GREAT COVERAGE AT A GREAT VALUE

LIME: 5210-61_* BLACK: 5210-62_* PINK: 5210-63_*

S-XL: \$179.95 XLT-2XL: \$189.95



*ADD CORRESPONDING SIZE NUMBER AT END OF 6-DIGIT PART #.

| SIZE | SIZE P/N | S | M | MT | L | LT | XL | XLT | 2XL |
|------|----------|---|---|----|---|----|----|-----|-----|
| | | 1 | 2 | 3 | 4 | 5 | 6 | 7 | 8 |

Thinsulate
INSULATION



A-B. FASHION FIT™ (SHOWN ON PAGE 24)

- 200 GRAMS THINSULATE™ FLEX INSULATION IN SEAT AND HIPS
- 150 GRAMS THINSULATE™ FLEX INSULATION IN THIGH/LEGS
- EXCELLENT RANGE OF MOTION FROM STRETCH FABRIC
- SLEEK, WOMEN'S-ONLY STYLE

A. PANTS: 5200-89_*
XS-XL: \$169.95 XLT-2XL: \$179.95

B. Bibs: 5200-88_*
XS-XL: \$179.95 XLT-2XL: \$189.95



BOSS CAT PANTS

- WATERPROOF, BREATHABLE, A-TEX-COATED FABRIC WITH FULLY TAPED SEAMS
- ULTRAWARM, BULK-FREE 200 GRAMS THINSULATE™ INSULATION
- UNIQUE HIGH-BACK BIB PREVENTS SNOW AND COLD FROM ENTERING PANTS
- ADJUSTABLE, REMOVABLE SUSPENDERS EASILY ZIP OFF TO CONVERT INTO WAIST-HIGH PANTS

5200-81_*

XS-XL: \$199.95
XLT-2XL: \$209.95



PREMIUM BIBS

- ULTRAWARM, BULK-FREE 200 GRAMS THINSULATE™ INSULATION
- WATERPROOF, BREATHABLE, A-TEX-COATED FABRIC WITH FULLY TAPED SEAMS
- EXTRA-PROTECTIVE FULL BIB TOP
- CONVENIENT DROP-SEAT STYLE
- AVAILABLE IN A SHORT-LENGTH INSEAM

5200-78_* , -790 4XL

XS-XL: \$199.95
XLT-3XL: \$209.95
4XL: \$219.95

5201-16_* (SHORT-LENGTH INSEAM)

XS-XL: \$199.95 2XL: \$209.95



SNO PRO PANTS

- DURABLE, TEFLON-TREATED NYLON OUTER SHELL
- WATERPROOF, BREATHABLE COATING IS SANDWICHED BETWEEN OUTER SHELL AND MICRO-MESH NYLON INNER LINING
- LAMINATED LAYERS FORM A WATERPROOF, BREATHABLE 3-LAYER FABRIC
- UNIQUE HIGH-BACK BIB PREVENTS SNOW AND COLD FROM ENTERING PANTS
- ADJUSTABLE, REMOVABLE SUSPENDERS EASILY ZIP OFF TO CONVERT INTO WAIST-HIGH PANTS

5200-84_*

S-XL: \$249.95
XLT-3XL: \$259.95



ADVANTAGE PANTS

- ULTRAWARM, BULK-FREE 200 GRAMS THINSULATE™ INSULATION
- DRY-SEAT INSERT ACTS AS A MOISTURE BARRIER
- SNO-LOCK™ CUFFS KEEP BOOTS SNOW-FREE

5200-74_*

S-XL: \$149.95
XLT-2XL: \$159.95

CATGIRL BURNOUT TEE (PAGE 75)

*ADD CORRESPONDING SIZE NUMBER AT END OF 6-DIGIT PART #.

| SIZE | SIZE P/N | S | M | MT | L | LT | XL | XLT | 2XL | 2XLT | 3XL |
|------|----------|---|---|----|---|----|----|-----|-----|------|-----|
| | | 1 | 2 | 3 | 4 | 5 | 6 | 7 | 8 | 0 | 9 |





Liberate your little ones from the confines of the living room couch, wrap them in the all-day warmth of 200 grams Thinsulate™ Insulation and get 'em out there into that white world called winter. Complete with features like magnetic closures and dry inserts in the seat/knees to create a barrier between their skin and the cold.



Thinsulate
INSULATION



SNO PRO JACKET

- ULTRAWARM 200 GRAMS THINSULATE™ INSULATION
- MAGNETIC FRONT FLAP CLOSURE KEEPS SNOW AND COLD OUT
- SHORTER STYLE ALLOWS YOUR KIDS TO MOVE WITH EASE

ORANGE: 5210-56_* LIME: 5210-54_*
BLACK: 5210-55_*

4-10: \$109.95 12-16: \$119.95



CATGIRL GLAM COAT

- WARM, SUPERSOFT 200 GRAMS OF INSULATION
- LONGER STYLE GIVES GREAT COVERAGE AT A GREAT VALUE
- PRINTED FABRIC STANDS APART FROM THE CROWD

5210-57_*

4-10: \$109.95 12-16: \$119.95



LEOPARD CATGIRL BEANIE

5213-019: \$14.95

*ADD CORRESPONDING SIZE NUMBER AT END OF 6-DIGIT PART #.

| SIZE | SIZE P/N | 4 | 6 | 8 | 10 | 12 | 14 | 16 |
|------|----------|---|---|---|----|----|----|----|
| | | 0 | 1 | 2 | 3 | 4 | 5 | 6 |



TEAM ARCTIC COAT

- REMARKABLY WARM, BULK-FREE 200 GRAMS THINSULATE™ INSULATION
- MAGNETIC FRONT FLAP CLOSURE KEEPS SNOW AND COLD OUT
- LONGER STYLE PROVIDES ADDED COVERAGE FOR YOUR YOUNG RACER

LIME/BLACK: 5201-58_* BLACK: 5210-58_*
 ORANGE: 5210-60_* PINK: 5210-59_*

4-10: \$109.95 12-16: \$119.95

TEAM ARCTIC PANTS

- ULTRAWARM, BULK-FREE 200 GRAMS THINSULATE™ INSULATION
- DRY-SEAT INSERT ACTS AS A MOISTURE BARRIER
- SNO-LOCK CUFFS KEEP BOOTS SNOW-FREE

5201-59_*

4-10: \$109.95 12-16: \$119.95



*ADD CORRESPONDING SIZE NUMBER AT END OF 6-DIGIT PART #.

| SIZE | SIZE | 4 | 6 | 8 | 10 | 12 | 14 | 16 |
|------|------|---|---|---|----|----|----|----|
| P/N | 0 | 1 | 2 | 3 | 4 | 5 | 6 | |

Thinsulate
INSULATION

ADVANTAGE PANTS

- ULTRAWARM, BULK-FREE 200 GRAMS THINSULATE™ INSULATION
- DRY-SEAT INSERT ACTS AS A MOISTURE BARRIER
- SNO-LOCK CUFFS KEEP BOOTS SNOW-FREE

5201-15_*

4-10: \$99.95 12-16: \$109.95

*ADD CORRESPONDING SIZE NUMBER AT END OF 6-DIGIT PART #.

| SIZE | SIZE | 4 | 6 | 8 | 10 | 12 | 14 | 16 |
|------|------|---|---|---|----|----|----|----|
| P/N | 0 | 1 | 2 | 3 | 4 | 5 | 6 | |



PREMIUM PANTS

- ULTRAWARM, BULK-FREE 200 GRAMS THINSULATE™ INSULATION
- DRY-SEAT INSERT ACTS AS A MOISTURE BARRIER
- SNO-LOCK CUFFS KEEP BOOTS SNOW-FREE

5200-82_*

4-10: \$109.95 12-16: \$119.95



ARCTIC CAT ONE-PIECE SUIT

- ULTRAWARM 200 GRAMS THINSULATE™ INSULATION
- BOLD, GROWN-UP LOOK FROM TEAM ARCTIC EMBROIDERY
- MOISTURE-BLOCKING SEAT AND KNEE INSERTS KEEP YOUR LITTLE RIDER WARM AND COMFY

LIME: 5210-52_* PINK: 5210-53_*

2-7: \$89.95

*ADD CORRESPONDING SIZE NUMBER AT END OF 6-DIGIT PART #.

| SIZE | SIZE | 2 | 3 | 4 | 5 | 6 | 7 |
|------|------|---|---|---|---|---|---|
| P/N | 0 | 1 | 2 | 3 | 4 | 5 | |

Thinsulate
INSULATION



PROLITE VEST

- PREMIUM PROTECTION FOR YOUNG RIDERS
- INCLUDES SHOULDER PADS

5212-940 (50-70 LBS.): \$169.95
5212-941 (70-100 LBS.): \$229.95

HELMETS

- SHOCK-ABSORBING, D.O.T.-APPROVED FIBERGLASS (PFP) OR POLYCARBONATE (MX) SHELL
- ANTI-FOG, DUAL-PANE FACE SHIELD



PFP GREEN:
5212-422 (M)
5212-424 (L)
\$119.95



PFP BLACK:
4262-682 (M)
4262-684 (L)
\$109.95

YOUTH HELMET STANDARD SIZING CHART

| HELMET SIZE | HEAD-HAT SIZE | HEAD CIRCUM. INCHES | HEAD CIRCUM. CENTIMETERS |
|-------------|---------------|---------------------|--------------------------|
| MEDIUM | 6 1/8 - 6 1/4 | 19 - 19 1/4 | 48 - 49 |
| LARGE | 6 3/8 - 6 1/2 | 19 1/2 - 20 | 50 - 51 |

THIS IS A GUIDELINE ONLY. HEAD SHAPE CAN VARY SIZE.

PFP PINK:
5212-432 (M)
5212-434 (L)
\$119.95



MX TEAM ARCTIC:
5212-442 (M)
5212-444 (L)
\$119.95



GOGGLES

- FITS KIDS' MX-STYLE HELMETS PERFECTLY
- SUPERIOR VISIBILITY FROM SCRATCH-RESISTANT LENSES
- DURABLE, RUGGED FRAME
- COMFORTABLE, ADJUSTABLE STRAP

4232-118: \$19.95



CAT PAW GLOVES

- NYLON SHELL FEATURES DURABLE, WATER-RESISTANT LEATHER PALM, FINGERS AND THUMB
- WARM, BULK-FREE 150 GRAMS THINSULATE™ INSULATION
- SNOW STAYS ON THE OUTSIDE FROM A HIGH CUFF WITH SECOND INNER KNIT CUFF

GREEN: 5212-08_* BLACK: 5212-11_*

CAT PAW MITTS

GREEN: 5212-09_* BLACK: 5212-12_*

S-XL: \$24.95



AIRCAT FACEMASK

- MOISTURE-WICKING ACRYLIC KNIT FABRIC
- EXCELLENT WARMTH ACROSS NECK AND SHOULDERS FROM A SNUG FIT

5212-587: \$12.95



PROCLAVA

- SLEEK, MOISTURE-WICKING POLYESTER TOP WON'T AFFECT HELMET FIT AND COMFORT
- ADDED PROTECTION IN FACE AND NECK FROM POLYESTER FLEECE CONSTRUCTION
- EXCELLENT SNOW AND COLD NECK PROTECTION FROM A FULL BIB DESIGN

5212-583: \$12.95



TEAM ARCTIC SPLATTER BEANIE

GREEN: 5213-017
ORANGE: 5213-018

\$12.95

TEAM ARCTIC STRIPE BEANIE

GREEN: 5213-015
GRAY: 5213-016

\$8.95



SNOW BOOTS ** (SEE PAGE 54)

- WATER-RESISTANT, DURABLE 500-DENIER NYLON UPPERS
- WARM, COMFY, REMOVABLE 6MM LINER
- TOUGH, WATERPROOF, INJECTION-MOLDED BOTTOM
- FOR COMFORT RATING, SEE PAGE 54

5212-4_* (8-13, 1-6): \$44.95

REPLACEMENT LINERS

4252-1_* (8-13, 1-6): \$9.95

*ADD CORRESPONDING SIZE NUMBER AT END OF 6-DIGIT PART #.

| SIZE | 8 | 9 | 10 | 11 | 12 | 13 | 1 | 2 | 3 | 4 | 5 | 6 |
|-----------|----|----|----|----|----|----|----|----|----|----|----|----|
| BOOT P/N | 60 | 61 | 62 | 63 | 64 | 65 | 66 | 67 | 68 | 69 | 70 | 71 |
| LINER P/N | 40 | 41 | 42 | 43 | 44 | 45 | 46 | 47 | 48 | 49 | 50 | 51 |



HOT PINK ARCTIC CAT TEE (PAGE 36)

Wearing an attitude's not necessarily a bad thing when that attitude's all about Cat™ pride. It's something we wholeheartedly support with cool Cat tees, jerseys, sweatshirts and more, all designed specifically for the little one in your life.



TEAM ARCTIC OXFORD HOODIE^Δ
-60% COTTON, 40% POLYESTER

5213-62_*

S-L: \$24.95



HOT PINK ARCTIC CAT ZIP HOODIE^Δ
-60% COTTON, 40% POLYESTER

5213-98_*

S-L: \$29.95



SKULL TEE^Δ
-100% COTTON

5213-73_*

S-L: \$9.95

AIRCAT JERSEY
-100% POLYESTER

GREEN
5213-673 (XS)
5213-67_* (S-L)

PINK
5213-683 (XS)
5213-68_* (S-L)

XS-L: \$29.95



TEAM ARCTIC JERSEY
-100% POLYESTER

5213-663 (XS)
5213-66_* (S-L)

XS-L: \$29.95

^ΔFEATURES ARCTIC CAT SCREENPRINTED LOGO

*ADD CORRESPONDING SIZE NUMBER AT END OF 6-DIGIT PART #.

| SIZE | SIZE | S | M | L | 6M | 12M | 18M | 2T | 3T | 4T | 5/6 |
|------|------|---|---|---|----|-----|-----|----|----|----|-----|
| | P/W | 0 | 1 | 2 | 3 | 4 | 5 | 6 | 7 | 8 | 9 |



TEAM ARCTIC FLANNEL
-50% COTTON, 50% POLYESTER

HOODIE†
5213-14_*

S-L: \$34.95

PANTS‡
5213-15_*

S-L: \$19.95



PINK LEOPARD CATGIRL FLANNEL
-50% COTTON, 50% POLYESTER

HOODIE†
5213-16_*

S-L: \$34.95

PANTS
5213-17_*

S-L: \$19.95



HOT PINK SNOWFLAKE HOODIE‡
-60% COTTON, 40% POLYESTER

5213-65_*

S-L: \$24.95



TEAM ARCTIC BLACK ZIP HOODIE‡
-60% COTTON, 40% POLYESTER

5213-64_*

S-L: \$29.95



TRADE MY TEE**
-100% COTTON

SISTER: 5213-07_*

BROTHER: 5213-08_*

S-L: \$11.95



TEAM ARCTIC OXFORD TEE‡
-100% COTTON

5213-63_*

S-L: \$9.95

‡FEATURES ARCTIC CAT SCREENPRINTED LOGO

**FEATURES ARCTIC CAT HEAT TRANSFER LOGO

†FEATURES ARCTIC CAT APPLIQUÉ

*ADD CORRESPONDING SIZE NUMBER AT END OF 6-DIGIT PART #.

*ADD CORRESPONDING SIZE NUMBER AT END OF 6-DIGIT PART #.

| SIZE | SIZE | S | M | L | 6M | 12M | 18M | 2T | 3T | 4T | 5/6 |
|------|------|-------|-------|---|----|-----|-----|----|----|----|-----|
| | 6-8 | 10-12 | 14-16 | | | | | | | | |
| P/N | 0 | 1 | 2 | 3 | 4 | 5 | 6 | 7 | 8 | 9 | |

| SIZE | SIZE | S | M | L | 6M | 12M | 18M | 2T | 3T | 4T | 5/6 |
|------|------|-------|-------|---|----|-----|-----|----|----|----|-----|
| | 6-8 | 10-12 | 14-16 | | | | | | | | |
| P/N | 0 | 1 | 2 | 3 | 4 | 5 | 6 | 7 | 8 | 9 | |



KEY LIME ARCTIC CAT TEE**
-100% COTTON
5213-62_*
6M-5/6: \$8.95



HOT PINK ARCTIC CAT TEE**
-100% COTTON
5213-65_*
6M-5/6: \$8.95



ARCTIC CAT HOODIE**
-60% COTTON, 40% POLYESTER
OXFORD: 5213-63_*
PINK: 5213-64_*
2T-5/6: \$24.95



CATKID ZIP HOODIE**
-60% COTTON,
40% POLYESTER
OXFORD: 5213-60_*
PINK: 5213-61_*
6M-5/6: \$29.95



LIME ARCTIC CAT ROMPER**
-60% COTTON, 40% POLYESTER
5213-98_* (6M-18M)
5213-986 (24M)
6M-24M: \$16.95

ARCTIC CAT BIB**
-35% COTTON, 65% POLYESTER
5213-040: \$7.95



*ADD CORRESPONDING SIZE NUMBER AT END OF 6-DIGIT PART #.

| SIZE | SIZE | S | M | L | 6M | 12M | 18M | 2T | 3T | 4T | 5/6 |
|------|------|-----|-------|-------|----|-----|-----|----|----|----|-----|
| | SIZE | 6-8 | 10-12 | 14-16 | | | | | | | |
| | P/N | 0 | 1 | 2 | 3 | 4 | 5 | 6 | 7 | 8 | 9 |

**FEATURES ARCTIC CAT HEAT TRANSFER LOGO



TXI & PFP HELMET SIZING CHART

| HELMET SIZE | 2XS | XS | SMALL | MEDIUM | LARGE | XL | 2XL | 3XL |
|----------------------------------|-----------------|-----------------|-------------|-----------------|---------------|-----------------|-----------------|---------------|
| HEAD-HAT SIZE | 6 1/2 - 6 5/8 | 6 3/4 - 6 7/8 | 7 - 7 1/8 | 7 1/4 - 7 3/8 | 7 1/2 - 7 5/8 | 7 3/4 - 7 7/8 | 8 - 8 1/4 | 8 3/8 - 8 1/2 |
| HEAD CIRCUMFERENCE (INCHES) | 20 1/2 - 20 7/8 | 21 1/4 - 21 5/8 | 22 - 22 1/2 | 22 3/4 - 23 1/4 | 23 5/8 - 24 | 24 1/2 - 24 7/8 | 25 1/8 - 25 1/2 | 26 - 26 3/8 |
| HEAD CIRCUMFERENCE (CENTIMETERS) | 52 - 53 | 54 - 55 | 56 - 57 | 58 - 59 | 60 - 61 | 62 - 63 | 64 - 65 | 66 - 67 |

THIS IS A GUIDELINE ONLY. HEAD SHAPE CAN VARY SIZE.



- PROVEN PERFORMANCE
- FOG-REDUCING, THREE-WAY VAPOR CONTROL SYSTEM THAT:
 - DELIVERS FRESH AIR
 - CIRCULATES MOIST AIR OUT
 - MOVES WARM AIR OUT THE TOP OF YOUR HEAD
- FORM-FITTING, FOG-RESISTANT, REPLACEABLE CUSTOM EYE SEALS VENT MOISTURE FROM YOUR BREATH
- SHOCK-ABSORBING, D.O.T.-APPROVED FIBERGLASS SHELL AND CHINBAR
- GLARE-REDUCING REMOVABLE VISOR
- MOISTURE-WICKING SUPERCOMFORT INTERIOR LINING
- ANTI-FOG, DUAL-PANE FACE SHIELD
- WIND PROTECTION FROM THE SOFT, STRETCHABLE CHIN CURTAIN
- DURABLE, RELIABLE FACE SHIELD SECURES TIGHT WITH A ONE-SCREW RATCHET



TXi FLAT

GREEN: 5212-31_* BLACK: 5212-30_*

2XS-3XL: \$259.95



Proven performance



TXi BLACK

4262-51_* (2XS-3XL): \$239.95



*Add CORRESPONDING SIZE NUMBER AT END OF 6-DIGIT PART #.

| SIZE | SIZE | 2XS | XS | S | M | L | XL | 2XL | 3XL |
|------|------|-----|----|---|---|---|----|-----|-----|
| P/N | 3 | 0 | 1 | 2 | 4 | 6 | 8 | 9 | |



TXi AC

ORANGE: 5212-28_* BLACK: 5212-27_*
 GREEN: 5212-26_* PINK: 5212-29_*

2XS-3XL: \$259.95



Proven performance



- PREMIUM FIBERGLASS PROTECTION
- SHOCK-ABSORBING, D.O.T.-APPROVED FIBERGLASS SHELL AND CHINBAR
- ANTI-FOG, DUAL-PANE FACE SHIELD
- INCLUDES REMOVABLE BREATH DEFLECTOR



PFP AIRCAT
 ORANGE: 5212-33_* GREEN: 5212-32_*
 BLACK: 5212-34_* PINK: 5212-35_*

2XS-3XL: \$129.95



Premium fiberglass protection



Premium fiberglass protection



PFP BLACK
 4262-56_* (2XS-3XL): \$119.95

HELMET SHOWN WITH
 OPTIONAL ELECTRIC SHIELD

*ADD CORRESPONDING SIZE NUMBER AT END OF 6-DIGIT PART #.

| SIZE | SIZE P/N | 2XS | XS | S | M | L | XL | 2XL | 3XL |
|------|----------|-----|----|---|---|---|----|-----|-----|
| | | 3 | 0 | 1 | 2 | 4 | 6 | 8 | 9 |



Mx SNO CROSS SNO PRO

- EXTREMELY LIGHTWEIGHT — 2.9 LBS.
- D.O.T.- AND SNELL-APPROVED FIBERGLASS SHELL
- DUAL-INTAKE VENTILATION SYSTEM PROVIDES ULTIMATE COMFORT
- REMOVABLE/WASHABLE "ULTRALUX" LINER WICKS AWAY MOISTURE FOR ADDED COMFORT

BLACK: 5212-36_* ORANGE: 5212-59_*
S-2XL: \$319.95



- D.O.T.- AND SNELL-APPROVED "POWERCORE" POLYCARBONATE SHELL
- TWIN AIR INTAKE/EXHAUST VENTILATION SYSTEM
- REMOVABLE/WASHABLE "DURALUX" LINER
- INCLUDES REMOVABLE BREATH DEFLECTOR

Mx TEAM ARCTIC FLAT

ORANGE: 5212-38_* BLACK: 5212-37_* GREEN: 5212-39_*
S-2XL: \$149.95



Mx AC

- SHOCK-ABSORBING, D.O.T.- AND SNELL-APPROVED FIBERGLASS SHELL
- REMOVABLE, BRIGHT, SAFE TAILLIGHT BEACON WITH RED LED LIGHTS
- ANTI-FOG HEAT EXHAUST SYSTEM VENTING AT CHIN AND FOREHEAD
- INCLUDES REMOVABLE BREATH DEFLECTOR

GREEN: 5212-40_* BLACK: 5212-41_*
S-2XL: \$199.95



Mx SNO CROSS BLACK

5202-46_* (S-2XL): \$139.95

*ADD CORRESPONDING SIZE NUMBER AT END OF 6-DIGIT PART #.

| SIZE | SIZE P/N | S | M | L | XL | 2XL |
|------|----------|---|---|---|----|-----|
| | | 1 | 2 | 4 | 6 | 8 |

MX HELMET SIZING CHART

| HELMET SIZE | SMALL | MEDIUM | LARGE | XL | 2XL |
|----------------------------------|-----------------|-------------|-----------------|-----------------|-----------------|
| HEAD-HAT SIZE | 6 3/4 - 6 7/8 | 7 - 7 1/8 | 7 1/4 - 7 3/8 | 7 1/2 - 7 5/8 | 7 3/4 - 7 7/8 |
| HEAD CIRCUMFERENCE (INCHES) | 21 1/4 - 21 5/8 | 22 - 22 1/2 | 22 3/4 - 23 1/4 | 24 1/2 - 24 7/8 | 24 1/2 - 24 7/8 |
| HEAD CIRCUMFERENCE (CENTIMETERS) | 54 - 55 | 56 - 57 | 58 - 59 | 60 - 61 | 62 - 63 |

THIS IS A GUIDELINE ONLY. HEAD SHAPE CAN VARY SIZE. MX HELMETS GENERALLY RUN ONE SIZE SMALLER THAN TXi & PFP HELMETS.

Increased comfort for aggressive riders requiring head heat and moisture to quickly escape their helmet

Increased comfort for aggressive riders requiring head heat and moisture to quickly escape their helmet

SMITH® EVO GOGGLES

- SEALS AGAINST COLD SPOTS WITH DUAL-LAYER FACE FOAM
- DESIGNED WITH A LARGER FRAME TO COMFORTABLY ACCOMMODATE EYEGLASSES
- VENTING PROVIDES ADDITIONAL AIRFLOW AND MINIMIZES FOGGING

GREEN: 4282-863 BLACK: 4282-862

\$39.95

REPLACEMENT LENS — EVO

CLEAR: 4282-866 AMBER: 4282-868 SMOKE: 4282-867

\$16.95



SMITH/CARIBOU GOGGLES

- DESIGNED WITH A LARGER FRAME TO COMFORTABLY ACCOMMODATE EYEGLASSES
- CLEAR, ANTI-FOGGING DUAL LEXAN® LENS DESIGN
- COMFORTABLE FIT FROM AMPLE FACE FOAM COVERAGE

4202-831: \$39.95



SMITH QUICK-STRAP CARBON GOGGLES

- SEALS AGAINST COLD SPOTS WITH DUAL-LAYER FACE FOAM
- DESIGNED WITH A LARGER FRAME TO COMFORTABLY ACCOMMODATE EYEGLASSES
- VENTING IN LENS PROVIDES ADDITIONAL AIRFLOW AND MINIMIZES FOGGING
- CONVENIENT QUICK-RELEASE STRAP

4942-004: \$49.95



QUICK-STRAP ONLY
4962-342: \$19.95

REPLACEMENT LENS — CARIBOU/QUICK-STRAP

CLEAR: 4912-145 AMBER: 4912-146 SMOKE: 4912-147

\$16.95

ANTI-FOG CLEANER

- CLEANS AND ADDS FOG-RESISTANT PROTECTION TO GOGGLES, SHIELDS AND GLASSES

4222-012 (2 oz.): \$4.95



CATGIRL GLAM COAT (PAGE 23)
LEOPARD CATGIRL BEANIE (PAGE 46)
TOM CAT JACKET (PAGE 17)



SKULL PINSTRIPE

5213-013: \$16.95



SKULL WASHED

5213-014: \$15.95



SKULL BEANIE WITH BRIM

-100% ACRYLIC

5213-039: \$15.95



SKULL MOLDED

5213-012: \$11.95

100% cotton

100% cotton

100% cotton



TEAM ARCTIC REVERSIBLE

5213-011: \$13.95



TEAM ARCTIC SPLATTER

GREEN: 5213-009
ORANGE: 5213-010

\$14.95

LEOPARD CATGIRL

5213-000: \$17.95



TEAM ARCTIC WATCHMAN

-POLYESTER-LINED

5213-008: \$15.95



ARCTIC CAT

BLACK: 5213-001
GREEN: 5213-002

\$11.95



ARCTIC CAT STRIPE

GREEN: 5213-003
GRAY: 5213-004

\$9.95



ARCTIC CAT TEXTURED

5213-005: \$13.95

ARCTIC CAT LABEL

-POLYESTER-LINED

5213-006: \$11.95



ARCTIC CAT STITCH

5213-007: \$11.95

SYNTHETIC FUR-LINED AVIATOR HAT

-DURABLE POLYESTER/LYCRA® CONSTRUCTION

5219-00_* (S-XL): \$29.95



*ADD CORRESPONDING SIZE NUMBER AT END OF 6-DIGIT PART #.

| SIZE | SIZE P/N | S | M | L | XL |
|------|----------|---|---|---|----|
| | | 1 | 2 | 4 | 6 |



SNO PRO BALACLAVA

- COZY, COMFORT-STRETCH LYCRA®/NYLON FIT EASILY SLIDES UNDER HELMET
- ADDED COLD-AIR PROTECTION FROM AN EXTENDED NECK BIB
- SECURE, SNUG FIT
- SUBLIMATED LOGO

5212-580: \$19.95

PROCLAVA

- SLEEK, MOISTURE-WICKING POLYESTER TOP WON'T AFFECT HELMET FIT
- ADDED PROTECTION IN FACE AND NECK FROM POLYESTER FLEECE FABRIC
- EXCELLENT SNOW AND COLD NECK PROTECTION FROM A FULL BIB DESIGN

5212-582: \$15.95



ARCTICTEK BALACLAVA

- WARM, MOISTURE-WICKING POLYESTER FLEECE
- EXCELLENT UNDER-HELMET FIT FROM SMOOTH, STRETCHY OUTER SHELL
- SUPERIOR WARMTH AND PROTECTION FROM GENEROUS NECK COVERAGE

5212-581: \$17.95



THERMOLITE® FACEMASK

- MOISTURE-WICKING POLYESTER FABRIC
- COMFORTABLE FIT AT A GREAT VALUE

BLACK: 4912-028
GRAY: 4262-819

\$9.95



No-FOG®

- COMFORTABLE, FORM-FITTING NEOPRENE SHELL DEFLECTS BREATH AWAY TO PREVENT GOGGLES AND FACE SHIELD FROM FOGGING
- WARM, SOFT FLEECE LINING
- SECURE HOOK-AND-LOOP FASTENER

4212-014 (L) 4212-016 (XL)

\$44.95



FLEECE NECKIE

- WARM, MOISTURE-WICKING SOFT POLYESTER FLEECE
- SURROUNDS NECK WITH INSULATION TO PROTECT AGAINST WIND AND COLD

5212-585: \$9.95



FACEMASKS

- MOISTURE-WICKING ACRYLIC KNIT FABRIC
- EXCELLENT WARMTH ACROSS NECK AND SHOULDERS FROM A COMFORTABLE FIT

BLACK: 4912-019 \$13.95
AIRCAT: 5212-586 \$14.95



FLEECE DICKIE

- WARM, MOISTURE-WICKING SOFT POLYESTER FLEECE
- PROTECTS CHIN AND NECK AGAINST CHILLS

5212-584: \$14.95



NEOPRENE FACEMASK

- INSULATES AGAINST WIND WITH A WARM NEOPRENE SHELL
- SOFT FLEECE LINING RETAINS HEAT AND WICKS AWAY MOISTURE
- ADJUSTABLE, SECURE FIT FROM A VELCRO® CLOSURE

4212-87_* (S-L): \$19.95

*ADD CORRESPONDING SIZE NUMBER AT END OF 6-DIGIT PART #.

| SIZE | SIZE P/N | S | M | L |
|------|----------|---|---|---|
| | | 1 | 2 | 4 |



SNO PRO GLOVES
(PAGE 52)

TEAM ARCTIC HI-CUFF LEATHER

- ULTRADURABLE, DRUM-DYED COMPLETE GRADE A LEATHER
- WARM 150 GRAMS THINSULATE™ INSULATION
- WIDE-BARREL HIGH-CUFF DESIGN EASILY FITS OVER COAT SLEEVE FOR A SECURE FIT

BLACK: 5212-03_*
GREEN: 5212-02_*

S-2XL: \$99.95



COMPETITION

- ULTRADURABLE, DRUM-DYED GRADE A LEATHER PALM, FINGERS AND THUMB
- EXCELLENT PROTECTION FROM RUBBER-MOLDED KNUCKLE GUARD
- WARM 150 GRAMS THINSULATE™ INSULATION
- SECURE FIT FROM A MID-CUFF DESIGN

5212-04_* (S-2XL): \$64.95



TOURING HI-CUFF LEATHER

- ULTRADURABLE, DRUM-DYED COMPLETE HIGH-CUFF GRADE A LEATHER
- WARM 150 GRAMS THINSULATE™ INSULATION
- WIDE-BARREL CUFF DESIGN EASILY FITS OVER COAT SLEEVE FOR A SECURE FIT

5202-04_* (S-2XL): \$89.95



RACE PAW

- ULTRADURABLE, DRUM-DYED GRADE A LEATHER
- LIGHTWEIGHT, MOISTURE-WICKING, SOFT-BRUSHED NYLON LINING
- RACE GRIP FEEL ALLOWS FOR BETTER HANDLING
- SECURE ELASTIC CUFF WITH STRAP DESIGN

5212-07_* (S-2XL): \$69.95



LOW-CUFF LEATHER

- SUPERDURABLE, DRUM-DYED COMPLETE LOW-CUFF GRADE A LEATHER
- WARM 150 GRAMS THINSULATE™ INSULATION

5202-16_* (S-2XL): \$84.95



REMOVABLE MITT LINER

CAT PAW INTERCHANGER

- A TOTAL PACKAGE — THREE GLOVES/MITTS IN ONE
- ULTRADURABLE GRADE A LEATHER PALM, FINGERS AND THUMB
- WARM, BULK-FREE 150 GRAMS THINSULATE™ INSULATION
- REFLECTIVE PIPING ON THE BACK OF THE HAND
- ADDED WARMTH IN EXTREME COLD FROM A SEPARATE, REMOVABLE POLYESTER/FLEECE LINER

MITTS

5212-18_* (S-2XL): \$59.95

GLOVES

MEN'S:

BLACK: 5212-16_* ORANGE: 5212-15_* GREEN: 5212-14_*

WOMEN'S:

BLACK: 5212-17_* (S-L)

S-2XL: \$59.95



REMOVABLE GLOVE LINER

A-TEX

- WATERPROOF, BREATHABLE A-TEX INSERT
- ULTRADURABLE GRADE A LEATHER PALM, FINGERS AND THUMB
- BUILT-IN WIPER BLADE ALLOWS QUICK CLEARING OF GOGGLES OR FACE SHIELD

BLACK: 5212-06_* GREEN: 5212-05_*

XS-2XL: \$69.95



*ADD CORRESPONDING SIZE NUMBER AT END OF 6-DIGIT PART #.

| SIZE | SIZE P/N | XS | S | M | L | XL | 2XL |
|------|----------|----|---|---|---|----|-----|
| | | 0 | 1 | 2 | 4 | 6 | 8 |



SNO PRO

- OFFERS BETTER FEEL FROM WASHABLE, DURABLE CLARINO™ SYNTHETIC LEATHER PALM, FINGERS AND THUMB
- LIGHTWEIGHT INSULATION PROVIDES EXCELLENT GRIP CONTACT
- WATERPROOF, BREATHABLE A-TEX INSERT
- SECURE, PULL-ON KNIT ELASTIC CUFF

LIME GREEN: 5212-23_* BLAZE ORANGE: 5212-24_*

S-2XL: \$49.95

ADVANTAGE

- EXCELLENT VALUE
- WATER-RESISTANT NYLON SHELL WITH DURABLE LEATHER PALM, FINGERS AND THUMB
- WARM, BULK-FREE 150 GRAMS THINSULATE™ INSULATION
- SECURE, SNUG, OVER-SLEEVE FIT FROM WIDE-BARREL HIGH-CUFF DESIGN

MITTS

5212-22_* (S-2XL): \$39.95

GLOVES

GREEN: 5212-20_* BLACK: 5212-21_* ORANGE: 5212-19_*

S-2XL: \$39.95



*ADD CORRESPONDING SIZE NUMBER AT END OF 6-DIGIT PART #.

| SIZE | SIZE P/N | XS | S | M | L | XL | 2XL |
|------|----------|----|---|---|---|----|-----|
| | | 0 | 1 | 2 | 4 | 6 | 8 |



Thinsulate
INSULATION



PIT BOSS

- OFFERS BETTER FEEL FROM WASHABLE, DURABLE CLARINO™ SYNTHETIC LEATHER PALM, FINGERS AND THUMB
- IDEAL MECHANIC'S GLOVE
- COMFORTABLE PADDED MESH BACKING
- EASY-ON/EASY-OFF, PULL-ON ELASTIC CUFF

5212-13_* (S-2XL): \$29.95



WINDBLOCK

- SOFT, BULK-FREE WINDPROOF POLYESTER FLEECE
- SECURE, PULL-ON ELASTIC KNIT CUFF

5202-25_* (XS-2XL): \$29.95



NEOPRENE

- OFFERS BETTER FEEL FROM WASHABLE, DURABLE CLARINO™ SYNTHETIC LEATHER PALM, FINGERS AND THUMB
- WARM, WINDPROOF NEOPRENE SHELL
- WATERPROOF, BREATHABLE A-TEX INSERT

5212-25_* (S-2XL): \$49.95

****Arm yourself against the cold with this handy comfort rating scale, a highly scientific, lab- and field-tested rating system developed by the footwear industry to help advise you on which boots to wear when you step-out into that winter land of wonder.**

Note: As with any rating system, this is more of a suggestion than a rule and should only be used as a comparison guideline, NOT an actual temperature guide. Variables affecting cold-weather protection include circulation, level of activity, presence of moisture, body temperature, windchill and outerwear.



-100 °F
-74 °C

CAT TRACKER™ EXTREME**

- DURABLE, WATER-RESISTANT LEATHER UPPERS
- WARM, COMFORTABLE 18MM REMOVABLE ZYLEX® LINER
- 11MM INSOLE CREATES A BARRIER OF WARMTH BETWEEN FOOT AND COLD WEATHER

5212-45 _ * (7-13): \$169.95

REPLACEMENT LINERS:

4252-10 _ * (7-13): \$39.95

*ADD CORRESPONDING SIZE NUMBER AT END OF 6-DIGIT PART #.

| | | | | | | | |
|------|---|---|---|----|----|----|----|
| SIZE | 7 | 8 | 9 | 10 | 11 | 12 | 13 |
| P/N | 0 | 1 | 2 | 3 | 4 | 5 | 6 |



-40 °F
-40 °C

ARCTIC CAT SNO CROSS**

- WATER-RESISTANT, DURABLE 1200-DENIER NYLON UPPERS
- COMFORTABLE, SECURE ERGONOMIC COMFORT ANKLE CUFF KEEPS SNOW AND MOISTURE OUT
- QUICK-DRYING REMOVABLE LINER WITH SHOCK-ABSORBING EVA FOAM FOOTBED
- SUPERIOR ANKLE SUPPORT FOR AGGRESSIVE RIDERS
- BOOTS RUN SMALLER IN SIZING; INCREASE SIZE BY 1 - 1 1/2 MORE THAN YOUR REGULAR SHOE SIZE

5202-45 _ * (7-13): \$199.95

REPLACEMENT LINERS:

4282-89 _ * (7-13): \$49.95

*ADD CORRESPONDING SIZE NUMBER AT END OF 6-DIGIT PART #.

| | | | | | | | |
|------|---|---|---|----|----|----|----|
| SIZE | 7 | 8 | 9 | 10 | 11 | 12 | 13 |
| P/N | 0 | 1 | 2 | 3 | 4 | 5 | 6 |

ADVANTAGE**

- WATER-RESISTANT, 600-DENIER NYLON UPPERS
- WARM, COMFORTABLE 8MM REMOVABLE ZYLEX LINER
- CONVENIENT, EASY-ON/EASY-OFF
- GENEROUS SIZE OPTIONS ARE A GREAT VALUE TO FIT ANY FOOT

MEN'S:

5212-4 _ * (4-15): \$79.95

WOMEN'S:

5212-50 _ * (6-10): \$79.95

REPLACEMENT LINERS:

MEN'S:

5212-5 _ * (4-15): \$19.95

WOMEN'S:

5212-54 _ * (6-10): \$19.95

WOMEN'S SIZING CHART

*ADD CORRESPONDING SIZE NUMBER AT END OF 6-DIGIT PART #.

| | | | | | |
|------|---|---|---|---|----|
| SIZE | 6 | 7 | 8 | 9 | 10 |
| P/N | 0 | 1 | 2 | 3 | 4 |

MEN'S SIZING CHART

*ADD CORRESPONDING SIZE NUMBER AT END OF 6-DIGIT PART #.

| | | | | | | | | | | | | |
|-----------|----|----|----|----|----|----|----|----|----|----|----|----|
| SIZE | 4 | 5 | 6 | 7 | 8 | 9 | 10 | 11 | 12 | 13 | 14 | 15 |
| BOOT P/N | 80 | 81 | 82 | 83 | 84 | 85 | 86 | 87 | 88 | 89 | 90 | 91 |
| LINER P/N | 20 | 21 | 22 | 23 | 24 | 25 | 26 | 27 | 28 | 29 | 30 | 31 |

-40 °F
-40 °C



-58 °F
-50 °C

EXPEDITION**

- DURABLE, WATER-RESISTANT LEATHER UPPERS
- THE UTMOST IN WARMTH AND COMFORT FROM 400G GRAMS THINSULATE™ ULTRA INSULATION
- WATERPROOF, DURABLE, INJECTION-MOLDED BOTTOM

5212-51 _ * (7-13): \$109.95

*ADD CORRESPONDING SIZE NUMBER AT END OF 6-DIGIT PART #.

| | | | | | | | |
|------|---|---|---|----|----|----|----|
| SIZE | 7 | 8 | 9 | 10 | 11 | 12 | 13 |
| P/N | 0 | 1 | 2 | 3 | 4 | 5 | 6 |

Thinsulate™ Ultra
INSULATION

**A. ARCTIC CAT BIG ROLLER**

- LARGE STORAGE BAG FOR ALL YOUR RIDE GEAR
- ROLLS SMOOTHLY AND QUIETLY ON POLYURETHANE WHEELS
- CONVENIENT TWO-STAGE EXTENDABLE HANDLE
- 6,000 CU. IN., 8 LBS., 35 IN. X 14 IN. X 14 IN.

5212-945: \$129.95

B. ARCTIC CAT SMALL ROLLER

- ROLLS SMOOTHLY AND QUIETLY ON POLYURETHANE WHEELS
- CONVENIENT TWO-STAGE EXTENDABLE HANDLE
- 2,600 CU. IN., 6 LBS., 22 IN. X 14 IN. X 9 IN.

5212-944: \$79.95

C. ARCTIC CAT DUFFEL

- LARGE MAIN COMPARTMENT WITH SIDE SHOE POCKET
- ADJUSTABLE PADDED SHOULDER STRAP
- 2,500 CU. IN., 1.6 LBS., 24 IN. X 14 IN. X 12 IN.

5212-943: \$39.95

Be it a week's vacation, a weekend getaway or seriously threatening to take a two-month sabbatical in the name of the ride, our massive selection of travel-grade, quality OGIO®-designed Cat gear bags are built to make packing effortless. Conveniently stow everything from boots to helmets and anything in between with these spacious bags and roller duffels, and do it with style.

**D. TEAM ARCTIC DUFFEL**

- LARGE-CAPACITY BAG WITH VENTED HELMET AND BOOT COMPARTMENTS
- SEPARATE COMPARTMENTS KEEP CLOTHES DRY
- 6,900 CU. IN., 6 LBS., 34 IN. X 14 IN. X 19 IN.

5202-504: \$109.95

E. HELMET BAG

- STYLISH BAG PROTECTS YOUR VALUABLE HELMET
- FLEECE-LINED INTERIOR AND REINFORCED CARRY HANDLE
- 800 CU. IN., 0.8 LBS., 18 IN. X 12 IN. X 10 IN.

5212-942: \$34.95



MANUFACTURED FOR ARCTIC CAT BY TEK RIDER™

PROLITE MAX

- PREMIUM PROTECTION FOR TRAIL RIDERS AND RACERS
- FULLY COMPATIBLE WITH ALL COMMERCIALY AVAILABLE NECK BRACES
- ALLOWS INCREASED AIRFLOW WITH COOLMAX LINING AND MESH OUTER PANELS FOR IMPROVED RIDER COMFORT
- FITS COMFORTABLY OVER/UNDER JACKETS, JERSEYS AND RACE SHELLS
- MEETS OR EXCEEDS ISR STANDARDS

5212-90_* (S-XL): \$439.95

MOUNTAIN TEK

- A LIGHTWEIGHT, BREATHABLE VEST THAT PROVIDES OPTIMAL PROTECTION FOR MOUNTAIN AND TRAIL RIDERS
- DESIGNED TO BE WORN OVER/UNDER A JACKET OR A LIGHT JERSEY IN WARMER CONDITIONS
- REVERSE-ENTRY POCKETS WITH WATERPROOF ZIPPERS AND INTERNAL KEY CLIP
- NOT RECOMMENDED FOR RACING
- ACCEPTS OPTIONAL SHOULDER PADS

5212-91_* (S-2XL): \$369.95



TRAIL TEK

- THE ULTIMATE UPPER-BODY PROTECTOR FOR TRAIL RIDERS
- CONVENIENT FRONT ZIPPER ACCESS
- REVERSE-ENTRY POCKETS WITH INTERNAL KEY CLIP
- EXCELLENT WIND-STOPPING AND MID-LAYER INSULATING PERFORMANCE
- INCLUDES A SOFT, ZIP-OFF FLEECE COLLAR
- ACCEPTS OPTIONAL SHOULDER PADS

5212-92_* (S-2XL): \$299.95

*ADD CORRESPONDING SIZE NUMBER AT END OF 6-DIGIT PART #.

| SIZE | SIZE | S | M | L | XL | 2XL |
|------|------|-----------|-----------|-----------|-----------|-----------|
| | LBS. | 130 - 150 | 150 - 185 | 185 - 210 | 210 - 240 | 240 - 270 |
| | P/N | 1 | 2 | 4 | 6 | 8 |



FLEX BELT

- OFFERS EXCELLENT LUMBAR AND KIDNEY SUPPORT
- WARM, INSULATING NEOPRENE CONSTRUCTION
- QUICK-ADJUST SIDE PULL COMFORTABLY ALIGNS YOUR SPINE

4292-82_* (S-XL): \$79.95



SHOULDER PADS

- QUICK-ATTACH DESIGN
- FITS TRAIL TEK AND MOUNTAIN TEK VESTS
- SOLD IN PAIRS

5212-932 (S/M)
5212-934 (L/XL)
5212-936 (2XL)

\$72.95

*ADD CORRESPONDING SIZE NUMBER AT END OF 6-DIGIT PART #.

| SIZE | WAIST | S | M | L | XL |
|------|--------|-----------|-----------|-----------|-----------|
| | INCHES | 22" - 29" | 30" - 35" | 36" - 43" | 44" - 52" |
| | P/N | 1 | 2 | 4 | 6 |



ZIP HOODIE (PAGE 75)
TEAM ARCTIC OXFORD (PAGE 63)

If variety is the spice of life, Cat-inspired sportswear adds a whole lot of style to your spice rack. It's all about performance gear and Cat passion, worn on your sleeve, pant leg, or pasted across your back. Within this lineup you'll find more than 100 products that tell the world what you'll be doing on any given winter day.



TEAM ARCTIC ZIP HOODIE^Δ
-100% COTTON

5209-24_*

S-XL: \$49.95 2XL: \$54.95 3XL: \$55.95

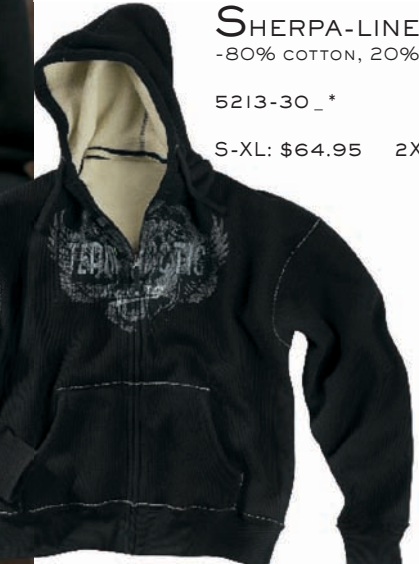

SHERPA-LINED THERMAL^Δ
-80% COTTON, 20% POLYESTER

5213-30_*

S-XL: \$64.95 2XL: \$69.95



1/2-ZIP TEAM ARCTIC HOODIE[†]
-80% COTTON, 20% POLYESTER

COAL: 5213-69_*
IVORY: 5213-70_*

S-XL: \$59.95 2XL: \$64.95 3XL: \$65.95



TEAM ARCTIC FRONT LACE[†]
-80% COTTON, 20% POLYESTER

5213-27_*

S-XL: \$64.95 2XL: \$69.95
3XL: \$70.95



ARCTIC CAT FRONT LACE^Δ
-80% COTTON, 20% POLYESTER

5213-28_*

S-XL: \$49.95 2XL: \$54.95
3XL: \$55.95



ARCTIC CAT MOTORSPORTS[†]
-80% COTTON, 20% POLYESTER

5213-29_*

S-XL: \$49.95
2XL: \$54.95
3XL: \$55.95

TWO-TONED SKULL HOODIE^{Δ†}
-80% COTTON, 20% POLYESTER

5213-83_*

S-XL: \$54.95 2XL: \$59.95 3XL: \$60.95

TEAM ARCTIC MOTORSPORTS ZIP HOODIE[†]
-80% COTTON, 20% POLYESTER

5213-74_*

S-XL: \$59.95
2XL: \$64.95
3XL: \$65.95



ARCTIC CAT FRONT-ZIP^{Δ†}
-80% COTTON, 20% POLYESTER

5213-82_*

S-XL: \$59.95 2XL: \$64.95
3XL: \$65.95

^ΔFEATURES ARCTIC CAT SCREENPRINTED LOGO
[†]FEATURES ARCTIC CAT APPLIQUE

*ADD CORRESPONDING SIZE NUMBER AT END OF 6-DIGIT PART #.

| SIZE | SIZE P/N | S | M | L | XL | 2XL | 3XL |
|------|----------|---|---|---|----|-----|-----|
| | | 1 | 2 | 4 | 6 | 8 | 9 |

*ADD CORRESPONDING SIZE NUMBER AT END OF 6-DIGIT PART #.

| SIZE | SIZE P/N | S | M | L | XL | 2XL | 3XL |
|------|----------|---|---|---|----|-----|-----|
| | | 1 | 2 | 4 | 6 | 8 | 9 |



ARCTIC CAT CAMO CREWNECK†
-50% COTTON, 50% POLYESTER
5213-99_*
S-XL: \$44.95 2XL: \$49.95
3XL: \$50.95



AIRCAT CREWNECK△
-50% COTTON, 50% POLYESTER
5213-97_*
S-XL: \$34.95 2XL: \$39.95
3XL: \$40.95



TEAM ARCTIC HENLEY△
5213-25_*
S-XL: \$38.95 2XL: \$43.95



TEAM ARCTIC SKULL△
5213-20_*
S-XL: \$29.95 2XL: \$34.95
3XL: \$35.95

TEAM ARCTIC FLANNEL HOODIE△†
-50% COTTON, 50% POLYESTER
5213-10_*
S-XL: \$59.95 2XL: \$64.95



ARCTIC CAT SWEATPANTS△
-80% COTTON, 20% POLYESTER
-9 OZ.
5213-71_*
S-XL: \$39.95 2XL: \$44.95

SKULL WAFFLE OXFORD△
5213-26_*
S-XL: \$44.95 2XL: \$49.95



TEAM ARCTIC FLANNEL PANTS△
-100% COTTON FLANNEL
5213-11_*
S-XL: \$29.95 2XL: \$34.95



TEAM ARCTIC SHORTS△
-100% COTTON
5213-57_*
XS-XL: \$29.95



△FEATURES ARCTIC CAT SCREENPRINTED LOGO
†FEATURES ARCTIC CAT APPLIQUE

*ADD CORRESPONDING SIZE NUMBER AT END OF 6-DIGIT PART #.

| SIZE | SIZE | XS | S | M | L | XL | 2XL | 3XL |
|------|------|----|---|---|---|----|-----|-----|
| P/N | | 0 | 1 | 2 | 4 | 6 | 8 | 9 |

TEAM ARCTIC OXFORD△
5213-24_*
S-XL: \$29.95 2XL: \$34.95
3XL: \$35.95



*ADD CORRESPONDING SIZE NUMBER AT END OF 6-DIGIT PART #.

| SIZE | SIZE | S | M | L | XL | 2XL | 3XL |
|------|------|---|---|---|----|-----|-----|
| P/N | | 1 | 2 | 4 | 6 | 8 | 9 |

100% cotton



CHARCOAL THERMAL
(PAGE 64)



VINTAGE WHITE FOOTBALL JERSEY^Δ

5213-21_*
S-XL: \$34.95 2XL: \$39.95



ARCTIC CAT SLED^Δ

5213-22_*
S-XL: \$29.95 2XL: \$34.95
3XL: \$35.95



MOTORSPORTS^Δ

5213-23_*
S-XL: \$29.95 2XL: \$34.95
3XL: \$35.95



CHARCOAL THERMAL^Δ
-60% COTTON, 40% POLYESTER

5213-19_*
S-XL: \$34.95 2XL: \$39.95
3XL: \$40.95 4XL: \$41.95



ARCTIC CAT T-NECK
-FEATURES ARCTIC CAT EMBROIDERY

LIME: 5219-01_*
WHITE: 5203-43_*
BLACK: 5203-42_*
S-XL: \$32.95 2XL: \$37.95
3XL: \$38.95 4XL: \$39.95

*ADD CORRESPONDING SIZE NUMBER AT END OF 6-DIGIT PART #.

| SIZE | SIZE P/N | S | M | L | XL | 2XL | 3XL | 4XL |
|------|----------|---|---|---|----|-----|-----|-----|
| | | 1 | 2 | 4 | 6 | 8 | 9 | 3 |

ΔFEATURES ARCTIC CAT SCREENPRINTED LOGO

GRAPHIC ON BACK



TEAM ARCTIC^Δ

5209-19_*
S-XL: \$19.95
2XL: \$24.95
3XL: \$25.95
4XL: \$26.95
5XL: \$27.95

GRAPHIC ON BACK



BAD TO THE BONE^Δ
-PIGMENT-DYED (CHARCOAL ONLY)

CHARCOAL: 5213-31_*
S-XL: \$34.95 2XL: \$39.95
BLACK: 5213-32_*
S-XL: \$19.95 2XL: \$24.95
3XL: \$25.95



FULL FRONT GRAPHIC

SKULL FLAMES^Δ

5213-34_*
S-XL: \$16.95 2XL: \$21.95
3XL: \$22.95 4XL: \$23.95 5XL: \$24.95

RACE TEAM^Δ
-ATHLETIC FIT

BLACK: 5213-84_*
OXFORD: 5213-85_*
S-XL: \$24.95
2XL: \$29.95



SNO PRO OXFORD^Δ

5213-36_*
S-XL: \$16.95
2XL: \$21.95
3XL: \$22.95

*ADD CORRESPONDING SIZE NUMBER AT END OF 6-DIGIT PART #.

| SIZE | SIZE P/N | S | M | L | XL | 2XL | 3XL | 4XL | 5XL |
|------|----------|---|---|---|----|-----|-----|-----|-----|
| | | 1 | 2 | 4 | 6 | 8 | 9 | 3 | 5 |



FACTORY RACE TEAM^Δ

5213-38_*
S-XL: \$16.95
2XL: \$21.95
3XL: \$22.95

Soft, smooth 100% cotton - Bold new graphics



SKULL WINGS V-NECK^Δ

5213-35_*
S-XL: \$24.95 2XL: \$29.95



TEAM ARCTIC SNO PRO^Δ
-PIGMENT-DYED

5213-33_*
S-XL: \$34.95 2XL: \$39.95



TEAM ARCTIC V-NECK^Δ

5213-56_*
S-XL: \$27.95 2XL: \$32.95



TEAM ARCTIC SCRIPT^Δ

5213-37_*
S-XL: \$16.95 2XL: \$21.95
3XL: \$22.95



ARCTIC CAT SMOKE^Δ
-HEAVYWEIGHT, BRUSHED COTTON
-ATHLETIC FIT

5213-39_*
S-XL: \$24.95 2XL: \$29.95



ARCTIC CAT R&D^Δ

OLIVE: 5213-41_*
BLACK: 5213-42_*
S-XL: \$16.95 2XL: \$21.95
3XL: \$22.95



HAT/TEE COMBO^Δ

5213-86_*
S-XL: \$24.95 2XL: \$29.95

^ΔFEATURES ARCTIC CAT SCREENPRINTED LOGO
*ADD CORRESPONDING SIZE NUMBER AT END OF 6-DIGIT PART #.

| SIZE | SIZE | S | M | L | XL | 2XL | 3XL |
|------|------|---|---|---|----|-----|-----|
| P/N | | 1 | 2 | 4 | 6 | 8 | 9 |

GOLF SHIRTS

-SOFT, SMOOTH 100% COTTON
-LONG-WEARING, DOUBLE NEEDED,
TOP-STITCHED SHOULDER AND
ARMHOLES
-FEATURES ARCTIC CAT EMBROIDERY



GOLF SHIRT

NATURAL: 5203-46_*
BLACK: 5203-47_*
S-XL: \$32.95 2XL: \$37.95
3XL: \$38.95 4XL: \$39.95

GOLF SHIRT WITH POCKET

PUTTY: 5203-45_*
ASH: 5203-44_*
S-XL: \$34.95 2XL: \$39.95
3XL: \$40.95 4XL: \$41.95



BUTTON-DOWN TWILL

-100% COTTON
-HANDY, REINFORCED CHEST POCKET
AND BUTTON-DOWN COLLAR
-FEATURES ARCTIC CAT EMBROIDERY

SHORT-SLEEVE:
KHAKI: 5209-05_*
BLACK: 5209-06_*

S-XL: \$39.95 2XL: \$44.95
3XL: \$45.95 4XL: \$46.95

LONG-SLEEVE:
BLACK: 5203-49_*
KHAKI: 5203-48_*

S-XL: \$44.95 2XL: \$49.95
3XL: \$50.95 4XL: \$51.95



ARCTIC CAT EXTREME^Δ

5213-40_*
S-XL: \$16.95 2XL: \$21.95
3XL: \$22.95



*ADD CORRESPONDING SIZE NUMBER AT END OF 6-DIGIT PART #.

| SIZE | SIZE | S | M | L | XL | 2XL | 3XL | 4XL |
|------|------|---|---|---|----|-----|-----|-----|
| P/N | | 1 | 2 | 4 | 6 | 8 | 9 | 3 |



TEAM ARCTIC PIT SHIRT

-65% COTTON, 35% POLYESTER
-COMPLETE WITH BOLD, FEARLESS ARCTIC CAT EMBROIDERY

5209-20_*

S-XL: \$79.95 2XL: \$84.95 3XL: \$85.95
4XL: \$86.95 5XL: \$87.95



ZIP SLEEVE OFF TO REMOVE



GRAPHITE CONVERSION WINDSHIRT

-100% POLYESTER
-FEATURES ARCTIC CAT EMBROIDERY

5213-81_*

XS-XL: \$74.95 2XL: \$79.95 3XL: \$80.95



ARCTIC CAT LONG-SLEEVE

-100% POLYESTER
-FEATURES ARCTIC CAT HEAT TRANSFER LOGO

5213-80_*

XS-XL: \$49.95 2XL: \$54.95
3XL: \$55.95 4XL: \$56.95



ARCTIC CAT GOLF SHIRT

ORANGE
-100% POLYESTER
-FEATURES ARCTIC CAT EMBROIDERY

5213-77_*

S-XL: \$49.95 2XL: \$54.95
3XL: \$55.95 4XL: \$56.95

BLACK
-100% POLYESTER SPANDEX
-FEATURES ARCTIC CAT EMBROIDERY
-MEN'S FEATURES BUTTON-UP COLLAR; WOMEN'S FEATURES OPEN V-NECK

MEN'S: 5213-78_* (S-3XL)
WOMEN'S: 5213-79_* (XS-2XL)

XS-XL: \$59.95 2XL: \$64.95
3XL: \$65.95



MEN'S

WOMEN'S

*ADD CORRESPONDING SIZE NUMBER AT END OF 6-DIGIT PART #.

| SIZE | SIZE P/N | XS | S | M | L | XL | 2XL | 3XL | 4XL | 5XL |
|------|----------|----|---|---|---|----|-----|-----|-----|-----|
| | | 0 | 1 | 2 | 4 | 6 | 8 | 9 | 3 | 5 |



HOT PINK CATGIRL TEE (PAGE 75)



SPONSOR

5209-21_*

S-XL: \$49.95 2XL: \$54.95 3XL: \$55.95

*ADD CORRESPONDING SIZE NUMBER AT END OF 6-DIGIT PART #.

| SIZE | SIZE P/N | S | M | L | XL | 2XL | 3XL |
|------|----------|---|---|---|----|-----|-----|
| | | 1 | 2 | 4 | 6 | 8 | 9 |

100% polyester



TEAM ARCTIC

5209-22_*

S-XL: \$49.95
2XL: \$54.95
3XL: \$55.95



AIRCAT

GREEN: 5213-59_*
PINK: 5209-23_*

S-XL: \$49.95
2XL: \$54.95
3XL: \$55.95

*ADD CORRESPONDING SIZE NUMBER AT END OF 6-DIGIT PART #.

| SIZE | SIZE P/N | S | M | L | XL | 2XL | 3XL |
|------|----------|---|---|---|----|-----|-----|
| | | 1 | 2 | 4 | 6 | 8 | 9 |



TEAM ARCTIC BURNOUT TEE (PAGE 75)

Break out the thermometer and watch it explode when you take the temperature of these hot styles. Designed with the wearer in mind, our snug, more modern Junior styles rock a slimmer cut through the body with shorter sleeves and bottom hem, while the Women's lineup is all about your proportions; not too big, never too little, with a waist that's neither too high nor too low. In a word, they're perfect. And hot.



ARCTIC CAT TEE^Δ

5213-87_*
S-XL: \$19.95
2XL: \$24.95



AIRCAT TEE^Δ

LAVENDER: 5213-88_*
EGGPLANT: 5213-89_*
S-XL: \$19.95
2XL: \$24.95

CATGIRL V-NECK^Δ

5213-53_*
S-XL: \$19.95
2XL: \$24.95



RHINESTONE LONG-SLEEVE^Δ

5213-55_*
S-XL: \$39.95 2XL: \$44.95

HEART LONG-SLEEVE^Δ

5213-94_*
S-XL: \$24.95 2XL: \$29.95



3/4-SLEEVE HEART V-NECK^Δ

5213-95_*
S-XL: \$24.95 2XL: \$29.95



SKULL LONG-SLEEVE^Δ

5213-52_*
S-XL: \$29.95 2XL: \$34.95



3/4-SLEEVE HOT PINK ARCTIC CAT TEE^Δ

5213-09_*
S-XL: \$24.95
2XL: \$29.95



ARCTIC CAT ZIP HOODIE†

BROWN: 5213-90_*
CREAM: 5213-91_*
S-XL: \$59.95 2XL: \$64.95

HOT PINK ARCTIC CAT HOODIE^{Δ†}

-50% COTTON,
50% POLYESTER
5213-96_*
S-XL: \$49.95
2XL: \$54.95
3XL: \$55.95



TEAL ARCTIC CAT V-NECK HOODIE^Δ

5213-92_*
S-XL: \$34.95
2XL: \$39.95



CORAL ARCTIC CAT HOODIE^Δ

5213-93_*
S-XL: \$34.95 2XL: \$39.95



ARCTIC CAT FLEECE PANTS^Δ

-60% COTTON,
40% POLYESTER
5213-76_* (S-XL): \$34.95

ARCTIC CAT ZIP HOODIE†

-80% COTTON,
20% POLYESTER
5213-75_*
S-XL: \$59.95
2XL: \$64.95
3XL: \$65.95



CHARCOAL SHORT-BRIM CATGIRL CAP

5213-038: \$14.95



ARCTIC CAT GLITTER CAP

5213-052: \$14.95

100% cotton

100% cotton

*ADD CORRESPONDING SIZE NUMBER AT END OF 6-DIGIT PART #.

| SIZE | SIZE P/N | S | M | L | XL | 2XL |
|------|----------|---|---|---|----|-----|
| | | 1 | 2 | 4 | 6 | 8 |

ΔFEATURES ARCTIC CAT SCREENPRINTED LOGO

†FEATURES ARCTIC CAT APPLIQUE

*ADD CORRESPONDING SIZE NUMBER AT END OF 6-DIGIT PART #.

| SIZE | SIZE P/N | S | M | L | XL | 2XL | 3XL |
|------|----------|---|---|---|----|-----|-----|
| | | 1 | 2 | 4 | 6 | 8 | 9 |



1/2-ZIP HOODIE†
 PURPLE: 5213-44_*
 BLACK: 5213-43_*
 S-XL: \$59.95



ZIP HOODIE^
 WHITE: 5213-45_*
 BLACK: 5213-46_*
 S-XL: \$49.95 2XL: \$54.95



HOT PINK CATGIRL TEE^
 5213-49_*
 S-XL: \$34.95



CATGIRL BURNOUT TEE
 5213-50_*
 S-XL: \$34.95



BLACK & GOLD 62 TEE^
 5213-48_*
 S-XL: \$34.95



TEAM ARCTIC BURNOUT TEE
 -50% COTTON,
 50% POLYESTER
 5213-72_*
 S-XL: \$34.95

*ADD CORRESPONDING SIZE NUMBER AT END OF 6-DIGIT PART #.

| SIZE | SIZE P/N | S | M | L | XL | 2XL |
|------|----------|---|---|---|----|-----|
| | | 1 | 2 | 4 | 6 | 8 |

^FEATURES ARCTIC CAT SCREENPRINTED LOGO
 †FEATURES ARCTIC CAT APPLIQUE

3/4-SLEEVE RHINESTONE THERMAL^Δ
-60% COTTON, 40% POLYESTER

5213-54_*
S-XL: \$39.95



CATGIRL LONG-SLEEVE^Δ

5213-51_*
S-XL: \$29.95 2XL: \$34.95



CATGIRL HOODED TEE^Δ

5213-47_*
S-XL: \$19.95 2XL: \$24.95



BROWN CATGIRL CAP

5213-037: \$14.95

^ΔFEATURES ARCTIC CAT SCREENPRINTED LOGO
[†]FEATURES ARCTIC CAT APPLIQUÉ

*ADD CORRESPONDING SIZE NUMBER AT END OF 6-DIGIT PART #.

| SIZE | SIZE P/N | S | M | L | XL | 2XL |
|------|----------|---|---|---|----|-----|
| | | 1 | 2 | 4 | 6 | 8 |



CATGIRL BURNOUT LONG-SLEEVE^Δ
-50% COTTON, 50% POLYESTER
5213-58_*
XS-XL: \$29.95

CATGIRL TANK TOP^Δ
5213-18_*
XS-XL: \$16.95

GRAPHIC ON BACK



*ADD CORRESPONDING SIZE NUMBER AT END OF 6-DIGIT PART #.

| SIZE | SIZE P/N | XS | S | M | L | XL | 2XL |
|------|----------|----|---|---|---|----|-----|
| | | 0 | 1 | 2 | 4 | 6 | 8 |

PINK LEOPARD CATGIRL FLANNEL

HOODIE[†]
-50% COTTON, 50% POLYESTER
5213-12_*

S-XL: \$59.95 2XL: \$64.95

PANTS
-100% COTTON FLANNEL

5219-02_*
S-XL: \$29.95 2XL: \$34.95

100% cotton



FACTORY RACE TEAM T-SHIRT (PAGE 65)



TEAM ARCTIC WASHED
5213-023: \$17.95



SKULL MESH
5213-028: \$16.95



TEAM ARCTIC FRAYED
5213-029: \$14.95

REALTREE®
5213-030: \$12.95



AIRCAT MESH
5213-032: \$14.95



TEAM ARCTIC PRO FIT
5209-181 (S/M)
5209-182 (L/XL)
\$19.95



ARCTIC CAT EST.
5213-035: \$16.95



BLACK TEAM ARCTIC FLAG
5213-026: \$14.95



WHITE TEAM ARCTIC FLAG
5213-027: \$19.95

SPONSOR
5209-180: \$18.95



ARCTIC CAT
5213-031: \$12.95



REFLECTIVE FLAMES
5213-025: \$19.95



ARCTIC CAT FLAMES
5213-036: \$16.95



ORANGE FLAMES
5213-024: \$14.95



TEAM ARCTIC FLAT BRIM
5213-020 (XS)
5213-021 (S/M)
5213-022 (L/XL)
\$17.95



ARCTIC CAT MESH
5213-033: \$16.95



BLACK ARCTIC CAT
5213-034: \$12.95



AIRCAT
5213-066: \$16.95

SUNGLASSES
-100% PLASTIC

- A. GREEN ICE: 5213-041 \$19.95
- B. BLUE ICE: 5213-042 \$19.95
- C. SILVER: 5213-043 \$19.95
- D. TITANIUM WITH DUST SHIELD: 5213-044 \$22.95
- E. BLACK WITH DUST SHIELD: 5213-045 \$22.95



LICENSE PLATE FRAME

5213-057: \$14.95



TEAM ARCTIC STREET SIGN

5213-058: \$9.95



AIRCAT PHOTO GLOBE
-INSERT YOUR OWN PHOTO

5213-061: \$14.95

TEAM ARCTIC KEYCHAIN LANYARD

5213-065: \$9.95



Z1 TURBO SNO PRO LE MODEL

-1/18-SCALE DIE-CAST MODEL

5213-053: \$63.95



STAINLESS STEEL-LINED TRAVEL MUG

5213-056: \$19.95



TEAM ARCTIC STAINLESS CAN COOLER

-SKULL AND TEAM ARCTIC FLAG LOGOS FEATURED ON OPPOSITE SIDES

5213-060: \$9.95



TEAM ARCTIC STAINLESS SHOT GLASS

5213-059: \$7.95



LIME COFFEE CUP
-100% CERAMIC

5213-055: \$9.95



GLASS TUMBLER (SET OF 4)

-15 oz.

5213-054: \$24.95

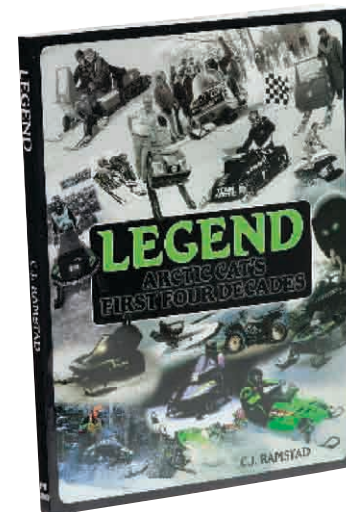

LEGEND BOOK

4209-199: \$9.95



CAN COOLERS

-HIGH-DENSITY FOAM

TEAM ARCTIC: 5213-063
AIRCAT: 5213-064

\$4.95



TEAM ARCTIC BOTTLE OPENER/KEYCHAIN

5213-062: \$4.95



MOTORSPORTS

6" 5213-046: \$4.95
 12" 5213-047: \$7.95
 24" 5213-048: \$20.95



CATGIRL

6" 5213-049: \$4.95
 12" 5213-050: \$7.95
 24" 5213-051: \$20.95



SKULL CAT

| | | |
|--------------|--------------|--------------|
| GREEN | ORANGE | CHROME |
| 3" 5209-004 | 3" 5209-007 | 3" 5209-010 |
| 6" 5209-005 | 6" 5209-008 | 6" 5209-011 |
| 12" 5209-006 | 12" 5209-009 | 12" 5209-012 |

3": \$5.95 6": \$8.95 12": \$12.95

TEAM ARCTIC

| | | |
|--------------|--------------|--------------|
| GREEN | ORANGE | CHROME |
| 6" 5209-013 | 6" 5209-016 | 6" 5209-019 |
| 12" 5209-014 | 12" 5209-017 | 12" 5209-020 |
| 24" 5209-015 | 24" 5209-018 | 24" 5209-021 |

6": \$8.95 12": \$12.95 24": \$19.95



ARCTIC CAT

ARCTIC CAT

| | | |
|--------------|--------------|--------------|
| BLACK | ORANGE | GREEN |
| 6" 4299-734 | 6" 4299-742 | 6" 4299-750 |
| 12" 4299-735 | 12" 4299-743 | 12" 4299-751 |
| 24" 4299-736 | 24" 4299-744 | 24" 4299-752 |
| 36" 4299-737 | 36" 4299-745 | 36" 4299-753 |

| | |
|--------------|--------------|
| WHITE | CHROME |
| 6" 4299-738 | 6" 4299-746 |
| 12" 4299-739 | 12" 4299-747 |
| 24" 4299-740 | 24" 4299-748 |
| 36" 4299-741 | 36" 4299-749 |

6": \$2.95 12": \$4.95 24": \$7.95 36": \$16.95



AIRCAT ARCTIC CAT

| | | |
|--------------|--------------|--------------|
| GREEN | ORANGE | WHITE |
| 6" 4299-725 | 6" 4299-728 | 6" 4299-731 |
| 12" 4299-726 | 12" 4299-729 | 12" 4299-732 |
| 24" 4299-727 | 24" 4299-730 | 24" 4299-733 |

6": \$5.95 12": \$8.95 24": \$21.95

Big trucks pull even bigger payloads of sleds, riders and their gear, so why not thank your ride for its years of chauffeuring servitude by giving it a new look? Skin the windows, add a Cat-proud license plate or throw down a set of floor mats for a look that'll announce your presence at any trailhead and make the masses move over.

WINDOW SKIN

- SEE-THROUGH DESIGN WON'T HINDER REAR VIEW
- TRIM TO FIT ANY CAR, TRUCK OR SUV
- EASY-TO-REMOVE, NON-PERMANENT ADHESIVE
- UNIVERSAL

5639-416: \$99.95



ARCTIC CAT STAINLESS STEEL LICENSE PLATE

5209-070: \$49.95

HITCH COVER

- DURABLE, HEAVY-DUTY ALUMINUM
- FITS 2-IN. HITCHES

5639-125: \$69.95



FLOOR MATS

- DEEP CHANNELS TRAP SLUSH AND DIRT
- PROTECTS YOUR FLOOR AND UPHOLSTERY
- SET OF 2
- UNIVERSAL

ARCTIC CAT: 5639-413
 TEAM ARCTIC: 5639-414

\$49.95

The F8 Sno Pro, tricked out to next-level awesomeness



F8 SNO PRO



F8 SNO PRO



As if a stock F8 weren't already a thing of beauty, along comes a mind-boggling selection of custom options that allows you to up the ante. Dig these headlight covers. FOX Float® AirShox™ and A-Arm deflectors. Sport bumper, rack and windscreen. Then, check out the drool coming off your buddies when you outfit your machine like this. Better keep a few shop rags handy, 'cause there's gonna be a lot of envy going around.

The M8 153-in. M Series, fully customized to absolutely devour any incline.



M8 (153)



M8 (153)



From the tunnel flares to the ski handles to the absolutely diabolical float converters and skid plates, the giant selection of accessories to customize your mountain sled takes a more-than-capable machine and makes it yours and yours alone. Riders appreciate not only the look they get from custom gear this well-built, but even more important benefits like the ability to dominate big mountain territory with both safety and style.

Lucky for you, all Cat sleds can be customized with the wide array of Cat accessories found in this extensive catalog, so let your imagination run wild, friends.

**PREMIUM**

- THE ULTIMATE OUTDOOR STORAGE COVER
- FADE-RESISTANT, UV-PROTECTED, LONG-LASTING SURLAST™ FABRIC
- ADJUSTABLE WINDSHIELD STRAP PROVIDES A CUSTOM WINDSHIELD/MIRROR FIT
- SUPERSNUG CINCH-DOWN STRAPS
- ADJUSTABLE VELCRO FRONT FASTENERS
- EASY-ACCESS, ZIPPERED GAS CAP PANEL
- TRAILERABLE

NOTE: '05-'08 M SERIES 162-IN. REQUIRES A CUSTOM COVER (5639-241)

5639-532:
'07-'11 F SERIES, ZI, ZI TURBO - GREEN \$219.95

5639-533:
'07-'11 F SERIES, ZI, ZI TURBO - ORANGE \$219.95

5639-534:
'10-'11 ZI TURBO EXT; '11 F8 EXT - GREEN \$229.95

5639-535:
'06-'11 CROSSFIRE - GREEN \$229.95

5639-536:
'06-'11 CROSSFIRE - ORANGE \$229.95

5639-537:
'09-'11 CFR - GREEN \$219.95

5369-538:
'09-'11 M SERIES, M8 HCR - GREEN \$229.95

5639-539:
'09-'11 M SERIES, M8 HCR - ORANGE \$229.95

5639-540:
'08-'11 T 570, TZI TOURING - BLACK \$229.95

**ARCTIC CAT**

- EXCELLENT LONGEVITY FROM SPECIALLY TREATED CANVAS
- CUSTOM WINDSHIELD/MIRROR FIT FROM AN ADJUSTABLE WINDSHIELD STRAP
- SUPERSNUG CINCH-DOWN STRAPS
- ADJUSTABLE VELCRO FRONT FASTENERS
- EASY-ACCESS, ZIPPERED GAS CAP PANEL
- TRAILERABLE



5639-541:
'09-'11 BEARCAT 570 \$209.95

5639-542:
'09-'11 BEARCAT 570 XT, BEARCAT ZI XT \$209.95

5639-543:
'06-'11 CROSSFIRE \$199.95

5639-283:
'06-'11 CROSSFIRE W/ 2-UP SEAT \$199.95

5639-544:
'09-'11 CFR \$189.95

5639-545:
'07-'11 F SERIES, ZI, ZI TURBO \$189.95

5639-546:
'07-'11 F SERIES, ZI W/ EXTREME HIGH WINDSHIELD \$189.95

5639-286:
'07-'11 F SERIES, ZI, ZI TURBO W/ 2-UP SEAT \$189.95

5639-547:
'10-'11 ZI TURBO EXT; '11 F8 EXT \$199.95

5639-548:
'09-'11 M SERIES, M8 HCR; '05-'08 M SERIES 153-IN. \$199.95

5639-549:
'08-'11 T 570, TZI TOURING \$209.95

5639-290:
'00-'11 120 \$99.95

TEAM ARCTIC

- FADE-RESISTANT, UV-PROTECTED, LONG-LASTING SURLAST FABRIC
- SUPERSNUG CINCH-DOWN STRAPS
- ADJUSTABLE VELCRO FRONT FASTENERS
- EASY-ACCESS, ZIPPERED GAS CAP PANEL
- TRAILERABLE



5639-568:
'07-'11 F SERIES; '09-'11 ZI, ZI TURBO \$219.95

5639-569:
'10-'11 SNO PRO 500 \$219.95

5639-616:
'10-'11 SNO PRO 500 W/ HIGH WINDSHIELD \$219.95

CUSTOM

- CUSTOM-FIT OPTIONS FOR NON-CURRENT SLED MODELS
- EXCELLENT LONGEVITY FROM SPECIALLY TREATED CANVAS
- SUPERSNUG CINCH-DOWN STRAPS
- ADJUSTABLE VELCRO FRONT FASTENERS
- EASY-ACCESS, ZIPPERED GAS CAP PANEL
- TRAILERABLE

5639-017:
'03-'06 FC, SC 128-IN. \$149.95

5639-018:
'99-'06 Z, ZR \$149.95

5639-241:
'05-'08 M SERIES 162-IN. \$159.95

5639-019:
'02-'04 MC; '04-'06 KC \$159.95

5639-020:
'00-'06 2-UP TOURING \$169.95

5639-021:
'03-'08 BC W/T \$169.95



5639-020

DUST COVER

- LIGHTWEIGHT AND IDEAL FOR STORAGE OR OVERNIGHT TRIPS
- SECURELY FITTING ELASTIC BOTTOM CORD
- NOT RECOMMENDED FOR TRAILERING

5639-571: 121-IN.-128-IN. \$69.95
5639-572: 2-UP TOURING \$79.95



5639-571



UNDERCOVER LINER

- USE WITH BOTH ARCTIC CAT AND PREMIUM COVERS

5639-570: UNIVERSAL \$44.95



COVER STORAGE BAG

- PROVIDES LIGHTWEIGHT, DURABLE AND COMPACT COVER STORAGE

4639-118: UNIVERSAL \$9.95



Just you, the trail and a destination called somewhere. That's the true draw of touring, getting as far away from it all as a throttle can take you. Of course, to make the miles more comfortable, you'd be wise to outfit yourself with a few trek-inspired touring accessories like Cat touring bags, racks, hitches and more.

TUNNEL PACK
 -MID-CAPACITY STORAGE
 -SECURE, EASY-TO-USE QUICK-FASTEN STRAPS



5639-573:
 '10-'11 F SERIES, ZI, ZI TURBO, ZI TURBO EXT; '11 F8 EXT \$69.95



5639-433:
 '10-'11 SNO PRO 500, M SERIES \$99.95



LXR SADDLEBAGS
 -ENORMOUS STORAGE BAG FOR ALL-DAY RIDING
 -EASY TO INSTALL

4639-445:
 '07-'09 F SERIES; '09 ZI \$149.95



CUSTOM HANDLEBAR BAG
 -LIGHTWEIGHT STORAGE FOR ANY SLED

5639-041: UNIVERSAL \$19.95



SPORT GEAR BAG
 -LARGE-CAPACITY STORAGE
 -SECURE, EASY-TO-USE QUICK-FASTEN STRAPS

5639-574:
 '10-'11 F SERIES, M SERIES, ZI, ZI TURBO, ZI TURBO EXT;
 '11 F8 EXT \$99.95



SEAT PACK
 -GENEROUS STORAGE FOR LARGER ITEMS
 -WON'T INTERFERE WITH SEAT ADJUSTMENTS ON LXR MODELS

5639-301:
 '07-'11 F SERIES, ZI, ZI TURBO, ZI TURBO EXT;
 '11 F8 EXT W/ FIXED OR ADJUSTABLE SEAT \$84.95



WINDSHIELD BAG
 -PROVIDES STORAGE FOR KEYS, WALLET, CELL PHONE, ETC.
 -FITS NEATLY BETWEEN GAUGES AND WINDSHIELD
 -5639-304 ACCEPTS WINDSHIELD BRACE KIT

4639-714:
 '08-'11 F SERIES, T 570, TZI TOURING;
 '09-'11 BC, ZI (SHOWN) \$52.95

5639-304:
 '09-'11 ZI TURBO, TZI TURBO TOURING \$52.95

4639-428:
 '05-'11 M SERIES; '06-'11 CF; '09-'11 CFR (SEE PAGE 114) \$39.95



CUSTOM SADDLEBAGS
 -SPACIOUS STORAGE
 -QUICK-ACCESS, ZIPPERED SIDE POCKETS
 -QUICK-REMOVAL CLIPS

4639-715:
 '07-'09 F SERIES; '09 ZI \$119.95



TOURING GEAR BAG
 -EASILY MOUNTS TO REAR RAILS
 -DOUBLES YOUR STORAGE WITH THE ZIP-OUT FEATURE
 -COMPLEMENTS TOURING SADDLEBAGS

5606-171:
 '08-'11 T 570, TZI TOURING; '09-'11 BC 570 \$104.95



TOURING SADDLEBAGS
 -PERFECT STORAGE SOLUTION FOR OVERNIGHT TRIPS
 -HEAVY-DUTY, CONTOURED PROTECTION

4639-712:
 '08-'11 T 570, TZI TOURING; '09-'11 BC 570 \$179.95



HANDLEBAR BAG
 -ZIPPERED TOP FLAP
 -LARGE ENOUGH FOR A CAP, CELL PHONE, WALLET, ETC.

4639-429:
 '07-'09 F SERIES, T 570, TZI TOURING;
 '09-'11 CFR; '10-'11 F SERIES LXR & SNO PRO, ZI LXR & SNO PRO

5639-303:
 '10-'11 F SERIES (STD), ZI (STD) (SHOWN)

4639-770:
 '05-'11 M SERIES; '06-'11 CF;
 '09-'11 BC 570, BC XT (SEE PAGE 114)

5639-434:
 '10-'11 SNO PRO 500

\$39.95



TANK BAG
 -LARGE STORAGE CAPACITY
 -EASY ACCESS, FULL-LENGTH ZIPPER
 -MAP WINDOW FOR QUICK REFERENCE

4639-426:
 '07-'11 F SERIES; '08-'11 T 570, TZI TOURING;
 '09-'11 BC 570, ZI, ZI TURBO \$52.95



UNDERHOOD BAG

-STORE TOOLS OR GEAR IN A CONVENIENT, OUT-OF-THE-WAY BAG

5639-305:
'09-'11 TZI TOURING, ZI (NON-TURBO) \$49.95



HANDLEBAR MUFFS

-WATER- AND WIND-RESISTANT NYLON OUTER
-EASY-ATTACH VELCRO STRAPS WITH AN ELASTIC GRIP STRAP

5639-621: UNIVERSAL \$39.95



SPORT MUFFS

-EASY-ON/EASY-OFF
-WARMTH WITHOUT THE WEIGHT
-QUICK VELCRO ATTACHMENT MOUNTS DIRECTLY TO HANDLEBARS
-INCLUDES INSIDE POCKET TO SLIDE OVER HAND GUARDS

5639-524: UNIVERSAL \$49.95



PASSENGER HAND MUFFS

-WATER- AND WIND-RESISTANT NYLON OUTER
-EASY-ATTACH VELCRO STRAPS
-MOUNTS WITH OR WITHOUT STANDARD WIND DEFLECTORS

5639-353:
'08-'11 T 570, TZI TOURING; '09-'11 BC 570, BC XT \$49.95



TUNNEL RAILS

-ADDS MOUNTING POCKETS FOR 2-UP SEAT OR RACK

5639-347: '10-'11 F SERIES, ZI, ZI TURBO \$59.95
5639-348: '10-'11 ZI TURBO EXT; '11 F8 EXT \$69.95



2-UP SEAT KIT

-CONVERTS YOUR SLED TO CARRY A PASSENGER
-INCLUDES PASSENGER SEAT WITH HANDHOLDS
-ACCEPTS REAR RACK OR BAG

5639-307:
'10-'11 F SERIES, ZI, ZI TURBO, ZI TURBO EXT;
'11 F8 EXT (REQUIRES TUNNEL RAILS)

5639-308:
'09-'11 CF, CFR (REQUIRES HITCH KIT WITH MOUNTING POCKETS, SEE PAGE 95)

\$349.95

TOOL ROLL

-SPACE-SAVING TOOL ORGANIZER
-ZIPPERED STORAGE POUCH
-TOOLS NOT INCLUDED

5639-047: \$19.95



UTILITY PACK

-CONVENIENT TOOL STORAGE
-ZIPPERED COMPARTMENT FOR A SPARE BELT
-TOOLS NOT INCLUDED

5639-110: \$29.95



5639-310

SPORT BUMPER

- COOL LINES FOR A BOLD LOOK
- SCRATCH-RESISTANT, LIGHTWEIGHT, POWDER-COATED STEEL

'07-'11 F SERIES; '08-'11 T 570, TZI TOURING;
'09-'11 BC 570, ZI, ZI TURBO
5639-309: BLACK
5639-310: GREEN
5639-311: ORANGE

\$99.95

'10-'11 SNO PRO 500 (ALUMINUM)
5639-065: GREEN \$139.95



5639-065

**SPORT RACK**

- LIGHTWEIGHT, POWDER-COATED ALUMINUM RACK MOUNTS DIRECTLY TO THE TUNNEL, OR QUICK-ATTACH TO TUNNEL RAILS (SEE PAGE 93)

'10-'11 F SERIES, ZI, ZI TURBO,
ZI TURBO EXT; '11 F8 EXT
5639-313: GREEN
5639-314: ORANGE
5639-315: UNPAINTED

\$59.95

CROSSFIRE™ RACK

- DETACHABLE, POWDER-COATED ALUMINUM RACK
- QUICK-RELEASE PINS MAKE IT PERFECT FOR YOUR CROSS-COUNTRY NEEDS
- REQUIRES HITCH KIT (SEE PAGE 95)

'09-'11 CF, CFR (REQUIRES HITCH KIT WITH MOUNTING POCKETS)
5639-155: GREEN 5639-156: ORANGE 5639-157: UNPAINTED

\$99.95

**TOURING BUMPER**

- DURABLE STEEL CONSTRUCTION WITH A TOUGH, POWDER-COAT FINISH

5639-312:
'07-'11 F SERIES; '08-'11 T 570, TZI TOURING;
'09-'11 BC 570, ZI (NON-TURBO) \$129.95



LONG

TOURING RACK

- DURABLE ALUMINUM CONSTRUCTION
- USE SHORT RACK WHEN PASSENGER SEAT IS INSTALLED, LONG RACK WHEN REMOVED

NOTE: INTERFERES WITH ATTACHMENT OF
TOURING SADDLEBAGS

'08-'11 T 570, TZI TOURING;
'09-'11 BC 570
5639-316: SHORT \$79.95
5639-317: LONG \$99.95



SHORT



5639-166

HITCH KITS

- INCLUDES STRONG, SECURE STEEL BUMPER WITH HITCH
- PIVOT-STYLE HITCH
- CROSSFIRE, CFR KITS INCLUDE MOUNTING POCKETS FOR 2-UP SEAT AND RACK

5639-318:
'10-'11 F SERIES, ZI, ZI TURBO
128-IN. \$99.95

5639-319:
'10-'11 ZI TURBO EXT; '11 F8 EXT
144-IN. \$99.95

4639-966:
'09 F SERIES, ZI, ZI TURBO
128-IN. \$179.95

5639-158:
'09-'11 M SERIES, M8 HCR
153-IN. \$99.95

5639-159:
'09-'11 M SERIES 162-IN. \$99.95

5639-166:
'09-'11 CF 141-IN. \$99.95

5639-202:
'09-'11 CFR 128-IN. \$99.95

4639-723:
'08-'11 T 570, TZI TOURING
(PIVOT) \$59.95

4639-907:
'08-'11 T 570, TZI TOURING
(PINTLE) \$69.95

**TOW HITCH**

- QUICK AND EASY INSTALLATION
- MOUNTS TO STANDARD BUMPER

5639-324:
'09-'11 CF, CFR, M SERIES;
'10-'11 F SERIES, ZI, ZI TURBO,
ZI TURBO EXT; '11 F8 EXT
\$49.95

PINTLE CONVERSION KIT

- CONVERTS THE HITCH KITS LISTED TO A HEAVY-DUTY, PINTLE-STYLE HITCH

3639-189:
FITS HITCH KITS LISTED
ABOVE \$39.95



Put up to four miles of powdery white space between you and your riding partners (or about 5 miles if you're on flatland or lakes*) and you'll still clearly hear them begging you to let them catch up when you're equipped with the Cat Comm™ system. Not only is Cat Comm a supercomfy, hands-and hassle-free two-way radio that also plays MP3s,** it does double duty as a safety feature, ensuring you and your riding partners don't get separated. Unless, of course, a little solo session was your intention all along.



CAT COMM

- GUARANTEED RIDER-TO-RIDER CLARITY FROM GMRS TECHNOLOGY AND 15 CHANNELS (462 MHz)
- INPUT JACKS COMPATIBLE WITH MP3, CD AND AM/FM AND SATELLITE RADIO FORMATS
- SYSTEM INCLUDES GMRS RADIO, ANTENNA, WIRING HARNESS AND HANDLEBAR-MOUNTED SWITCH
- KIT INCLUDES MACHINE COMPONENTS ONLY
- ADD THE HELMET COMMUNICATION HEADSET (SOLD SEPARATELY) TO EQUIP YOUR CURRENT HELMET

COMMUNICATOR ONLY

4639-724:
'08-'11 F SERIES; '09-'11 ZI WITH DELUXE GAUGE \$459.95

COMMUNICATOR WITH PASSENGER INTERCOM

4639-725:
'08-'11 TZI TOURING WITH DELUXE GAUGE \$549.95

*ACTUAL RANGE VARIES BY TERRAIN AND CONDITION
**REQUIRES AN OUTSIDE MUSIC SOURCE

REMOTE START KIT

- WARM UP YOUR SLED BEFORE HITTING THE TRAIL
- WHEN ACTIVATED, SENTINEL MODE STARTS AND RUNS YOUR SLED FOR 12 MINUTES ONCE THE TEMPERATURE DROPS TO -4°F OR LOWER



5639-531: '08-'11 TZI TOURING; '09-'11 BC ZI XT, ZI
4639-848: '08-'09 T500; '08-'11 F SERIES LXR

\$279.95



HELMET COMMUNICATION HEADSET

- MAKES INSTALLATION ON YOUR CURRENT HELMET PAINLESS
- FITS COMFORTABLY INSIDE YOUR HELMET, NO EAR PHONES NECESSARY
- INCLUDES SPEAKERS, MIC, JUNCTION BOX/CLAMP AND POWER COIL CORD
- ADDITIONAL JACK PROVIDES HOOKUP FOR TXI ELECTRIC SHIELDS

4262-039: \$119.95

ELECTRIC START KIT

- START YOUR SLED WITH EASE
- INCLUDES HIGH-TORQUE STARTER MOTOR, HARDWARE AND BATTERY

5639-321: '10 BC 570
5639-199: '09 BC 570
5639-198: '09-'11 F SERIES 800, 1000
4639-803: '08-'11 CF, M SERIES 500, 600
4639-782: '08-'11 F SERIES 500, 600

\$549.95



ENGINE HEATER

- IMPROVES START-UP IN EXTREME WEATHER

4639-969:
'07-'11 ZI 4-STROKE; '09-'11 ZI TURBO (US & CAN) \$119.95

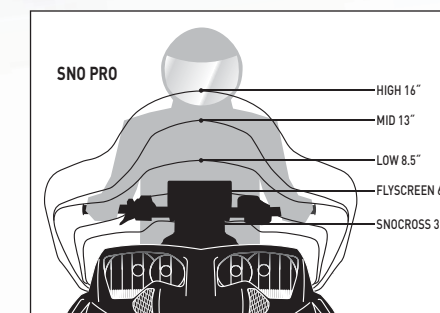
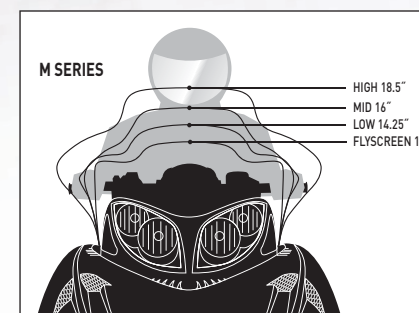
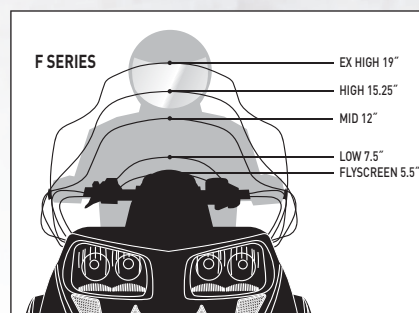

NOTE: MEASUREMENTS ARE TAKEN VERTICALLY FROM DASH PANEL TO TOP OF WINDSCREEN



5639-392



5639-391

FLYSCREENS

-ULTRALOW DESIGN OFFERS ENHANCED VISIBILITY



5639-525



5639-139

MID/HIGH/EXTREME HIGH WINDSHIELDS
-PROVIDES OPTIMAL WIND/SNOW PROTECTION



5639-439



5639-222



BRACE KIT

-OFFERS INCREASED WINDSHIELD STABILITY AT HIGH SPEEDS
-RECOMMENDED WHEN INSTALLING MIRRORS

5639-518:
TURBO LOW (5639-142, 5639-464, 5639-465)

5639-455:
TURBO HIGH (5639-154)

5639-519:
EXTREME HIGH (5639-222)

\$12.95



MOUNTING RING

-REPLACES THE STANDARD O-RING MOUNT

2606-853: UNIVERSAL \$0.99

WINDSCREENS

-SUPERB HAND PROTECTION FROM FULLY FLARED SIDES
-CHOOSE FROM A COOL MIRRORRED OR CUSTOM LOOK



5639-128



5639-449

'07-'11 F SERIES
'09-'11 ZI, TZI
'09-'11 BEARCAT

'05-'11 M SERIES
'06-'11 CROSSFIRE
'09-'11 CFR, M8 HCR

'09-'11 ZI TURBO,
TZI TURBO

'10-'11
SNO PRO 500

| | PART # | PRICE | PART # | PRICE | PART # | PRICE | PART # | PRICE |
|--------------------------|-----------|----------|----------|----------|-----------|----------|----------|---------|
| WINDSCREENS | | | | | | | | |
| FLYSCREEN, CHROME | 5639-131 | \$89.95 | 5639-137 | \$89.95 | 5639-391 | \$89.95 | 5639-450 | \$79.95 |
| FLYSCREEN, GREEN CHROME | N/A | | 5639-138 | \$89.95 | 5639-392 | \$89.95 | 5639-451 | \$79.95 |
| FLYSCREEN, ORANGE CHROME | N/A | | 5639-139 | \$89.95 | 5639-599 | \$89.95 | N/A | |
| FLYSCREEN, FLAT BLACK | 5639-132 | \$89.95 | 5639-140 | \$89.95 | 5639-248 | \$89.95 | N/A | |
| FLYSCREEN, PINK | N/A | | 5639-417 | \$89.95 | N/A | | N/A | |
| EXTREME LOW, BLACK | N/A | | 5639-525 | \$44.95 | N/A | | N/A | |
| EXTREME LOW, WHITE | N/A | | 5639-526 | \$44.95 | N/A | | N/A | |
| LOW, CHROME | 5639-127 | \$109.95 | 5639-133 | \$109.95 | *5639-464 | \$109.95 | N/A | |
| LOW, GREEN CHROME | 5639-128 | \$109.95 | 5639-134 | \$109.95 | *5639-465 | \$109.95 | N/A | |
| LOW, ORANGE CHROME | 5639-129 | \$109.95 | 5639-135 | \$109.95 | N/A | | N/A | |
| LOW, FLAT BLACK | 5639-130 | \$99.95 | 5639-136 | \$99.95 | *5639-142 | \$99.95 | 5639-449 | \$89.95 |
| LOW, PINK | 5639-178 | \$99.95 | N/A | | N/A | | N/A | |
| MID, TINT | 5639-439 | \$89.95 | 4639-203 | \$89.95 | N/A | | 5639-615 | \$89.95 |
| HIGH, TINT | 4639-719 | \$99.95 | 4639-227 | \$99.95 | *5639-154 | \$99.95 | 5639-500 | \$99.95 |
| EXTREME HIGH, CLEAR | *5639-222 | \$129.95 | N/A | | N/A | | N/A | |

*REQUIRES A WINDSHIELD BRACE KIT



Behold the realm of the true Cat-obsessed: The Custom Accessories section, where the tinkers reign supreme, fiddling with this part here, adding that sweet new performance piece there, and then retweaking the entire program into all hours of the night. This is where sleds are turned into statements, where individual styles are brought forth, and at the end of the day, where Cat riders leave lesser sleds in the snowbank.



Fox FLOAT R EVOL

- TAKE YOUR RIDING TO THE NEXT LEVEL OF PERFORMANCE AND ADJUSTABILITY
- MAIN AIR CHAMBER, EVOL™ AIR CHAMBER AND REBOUND ADJUSTMENTS
- FINE-TUNE RIDE HEIGHT AND PLUSHNESS INDEPENDENT OF BOTTOM-OUT RESISTANCE OR ROLL STIFFNESS
- UP TO 6 LBS. LIGHTER THAN CONVENTIONAL COIL-OVER SHOCKS
- INCLUDES TWO REBUILDABLE AND REVALVEABLE IFP SKI SHOCKS AND COMPACT FOX® HP AIR PUMP

5639-587: '07-'11 F SERIES; '09-'11 ZI, ZI TURBO
 5639-588: '05-'11 M SERIES
 5639-589: '06-'11 CF; '09-'11 CFR
 5639-590: '10-'11 SNO PRO 500

\$994.95



Fox FLOAT 2

- NEGATIVE SPRING TECHNOLOGY ALLOWS FOR FASTER, STIFFER CORNERING WHILE MAINTAINING AN ULTRAPLUSH RIDE
- ADVANCED VELOCITY-SENSITIVE HI-FLOW DAMPING
- UP TO 6 LBS. LIGHTER THAN CONVENTIONAL COIL-OVER SHOCKS
- INCLUDES TWO REBUILDABLE AND REVALVEABLE IFP SKI SHOCKS AND COMPACT FOX HP AIR PUMP

5639-583: '07-'11 F SERIES; '09-'11 ZI, ZI TURBO
 5639-584: '05-'11 M SERIES
 5639-585: '06-'11 CF; '09-'11 CFR
 5639-586: '10-'11 SNO PRO 500

\$694.95

AIRSHOX GUARDS

- PROTECTS FOX FLOAT® AIRSHOX, FLOAT 2 AND FLOAT R EVOL
- SOLD IN PAIRS

4639-136: ORANGE
 4639-135: GREEN
 4639-044: BLACK

\$29.95



PINK ACCESSORY KITS

- ACCESSORY KIT INCLUDES:
- WHITE BUMPER FASCIA, IDLER WHEELS AND SPRINGS
 - WHITE-STRIPED SEAT COVER (5639-607 & 5639-608)
 - ALL THE ESSENTIAL DECALS

5639-576: '11 F570 \$159.95
 5639-607: '11 F5 LXR \$299.95
 5639-608: '11 F8 LXR, ZI LXR \$299.95

OPTIONAL PINK ACCESSORIES

ADD THESE OPTIONS TO GIVE YOUR RIDE AN EVEN MORE CUSTOMIZED LOOK:

WINDSCREEN (PAGE 99) \$99.95
 HAND GUARDS (PAGE 103) \$34.95
 HAND GUARD MOUNTS (PAGE 103) \$29.95



SUSPENSION BLOCKS

- DURABLE, HEAVY-DUTY ANODIZED ALUMINUM
- DAMAGE RESISTANT DURING PRELOAD CHANGES
- SOLD IN PAIRS
- UNIVERSAL

4639-853: BLACK
4639-854: GREEN
4639-855: SILVER

\$49.95



SNO PRO HAND GUARDS

- WICKED STYLING
- DURABLE, INJECTION-MOLDED PLASTIC
- SOLD IN PAIRS; MOUNTS SOLD SEPARATELY
- REQUIRES LOW WINDSHIELD
- FITS MOUNTS 5639-264 & 5639-385

5639-581: BLACK
5639-384: GREEN
5639-261: ORANGE
5639-262: WHITE

\$39.95



RECOIL HANDLE

- CUSTOM ANODIZED BILLET ALUMINUM
- UNIVERSAL

5639-452: BLACK
5639-453: GREEN
5639-454: SILVER

\$52.95

BRAKE LEVER

- HEAVY-DUTY ANODIZED ALUMINUM DESIGN
- LIGHTWEIGHT, YET STRONGER THAN STOCK

ALL '07-'11 MODELS (EXCLUDES SNO PRO 500)
4639-797: BLACK
4639-798: GREEN
4639-799: SILVER

\$49.95



HAND GUARD EXTENSION

- FLEXIBLE CONSTRUCTION ADDS PROTECTION
- FITS SNO PRO HAND GUARDS (SHOWN ABOVE)
- SOLD IN PAIRS

5639-263: \$39.95



HAND GUARD MOUNTS

- CHOOSE FROM RUGGED ALUMINUM OR DURABLE, INJECTION-MOLDED NYLON CONSTRUCTION
- FITS SNO PRO HAND GUARDS (SHOWN ABOVE)
- SOLD IN PAIRS; REQUIRES LOW WINDSHIELD

ALUMINUM
5639-264:
'07-'11 F SERIES; '09-'11 CFR, ZI, ZI TURBO; '10-'11 SNO PRO 500 \$39.95

NYLON
5639-385:
'07-'11 CF, F SERIES, M SERIES; '09-'11 CFR, M8 HCR, ZI, ZI TURBO \$29.95



HAND GUARD MOUNTS

- CHOOSE FROM RUGGED ALUMINUM OR DURABLE, INJECTION-MOLDED NYLON CONSTRUCTION
- FITS ARCTIC CAT HAND GUARDS (SHOWN ON LEFT)
- SOLD IN PAIRS; REQUIRES LOW WINDSHIELD

ALUMINUM
4639-805:
'07-'11 F SERIES; '09-'11 CFR, ZI, ZI TURBO; '10-'11 SNO PRO 500 \$54.95

NYLON
4639-804:
'07-'11 CF, F SERIES, M SERIES;
'09-'11 CFR, M8 HCR, ZI, ZI TURBO \$29.95



ARCTIC CAT HAND GUARDS

- DURABLE, INJECTION-MOLDED PLASTIC
- SOLD IN PAIRS; MOUNTS SOLD SEPARATELY
- REQUIRES LOW WINDSHIELD
- FITS MOUNTS 4639-804 & 4639-805

4639-806: BLACK
4639-807: GREEN
4639-808: ORANGE
5639-179: PINK

\$34.95



POD SCREWS

- QUICKLY REMOVE THE DASH POD WITHOUT THE USE OF TOOLS
- SOLD IN PAIRS

'07-'11 F SERIES; '08-'11 T 570, TZI TOURING; '09-'11 BC 570, ZI, ZI TURBO
5639-593: BLACK
5639-594: SILVER

\$44.95



SHORTY LEVER

- DURABLE BILLET ALUMINUM WITH ANODIZED FINISH
- FEATURES A SLIM, TWO-FINGER DESIGN

ALL '07-'11 MODELS (EXCLUDES SNO PRO 500)
5639-505: BLACK
5639-506: SILVER

\$44.95





ARCTIC CAT SADDLELESS SKIS

- LIGHTWEIGHT PLASTIC SKIS ARE AVAILABLE IN TWO WIDTHS
- IDEAL FOR TRAIL RIDING OR COMMANDING DEEP POWDER
- 4-IN. CARBIDE WEARBARS INCLUDED
- FITS ALL APPLICATIONS, EXCLUDING CAST-ALUMINUM SPINDLES

5639-322:
6-IN. SKI KIT (PAIR) \$279.95

5639-323:
8-IN. SKI KIT (PAIR) \$329.95



C&A PRO ADX SKIS

- X EDGE SKI DESIGN OFFERS EXCELLENT CONTROL FOR THE AGGRESSIVE RIDER
- GREATLY REDUCES DARTING ON THE TRAILS FOR RECREATIONAL RIDERS
- BETTER FLOTATION FROM 6-IN.-WIDE PROFILE AND EXTRA RACING GROOVES IN SKI BOTTOM
- INCLUDES MOUNTING HARDWARE
- SOLD IN PAIRS; WEARBARS SOLD SEPARATELY
- FITS ALL APPLICATIONS, EXCLUDING CAST-ALUMINUM SPINDLES

5639-603:
6-IN. SKI KIT (PAIR) \$379.95

WEARBARS

5639-604:
6-IN. CARBIDE WEARBARS (PAIR) \$79.95

SEE YOUR DEALER FOR ADDITIONAL WEARBAR OPTIONS



SLP POWDER PRO SKIS™

- EXCEPTIONAL FLOAT AND CONTROL IN DEEP, LOOSE SNOW
- INCLUDES MOUNTING HARDWARE
- SOLD IN PAIRS; WEARBARS SOLD SEPARATELY
- FITS ALL APPLICATIONS, EXCLUDING CAST-ALUMINUM SPINDLES

5639-326:
7-IN. SKI KIT (PAIR) \$379.95

WEARBARS

3639-420:
4-IN. CARBIDE WEARBARS (PAIR) \$54.95

SEE YOUR DEALER FOR ADDITIONAL WEARBAR OPTIONS



ARCTIC CAT SKI HANDLES

- FITS ARCTIC CAT SADDLELESS SKIS
- SOLD IN PAIRS

3639-777: GREEN
3639-778: ORANGE

\$19.95

SKID PLATES

- ABSOLUTE IMPACT PROTECTION FROM BUMPER TO HEAT EXCHANGER
- SUPER-RUGGED, 1/4-IN.-THICK HIGH MOLECULAR WEIGHT POLYETHYLENE PROTECTS VITAL COMPONENTS

'07-'11 F SERIES; '08-'11 T 570, TZI TOURING; '09-'11 ZI, ZI TURBO; '10-'11 ZI TURBO EXT
4639-567: BLACK
4639-568: GREEN
4639-569: ORANGE

\$159.95

'05-'11 M SERIES; '06-'11 CF; '09-'11 CFR, M8 HCR
3639-838: BLACK \$119.95
3639-839: GREEN \$119.95
4639-564: ORANGE \$119.95
5639-582: WHITE \$119.95
5639-223: BLACK \$169.95



PRO GRIPS

- INCREDIBLE TRACTION FROM HEAVY-DUTY ALUMINUM CONSTRUCTION
- DURABLE POWDER-COAT FINISH
- INCLUDES 5 RIGHT- AND 5 LEFT-HAND GRIPS
- UNIVERSAL

4639-774: BLACK
4639-775: GREEN
4639-776: ORANGE
4639-777: UNPAINTED

\$49.95



GRIP PLATES

- EXCEPTIONAL TRACTION WITH DURABLE, LONG-LASTING, POWDER-COATED ALUMINUM CONSTRUCTION
- OFFERS COMPLETE FRONT-TO-REAR TUNNEL EDGE GRIP
- SOLD IN PAIRS

'10-'11 F SERIES, ZI, ZI TURBO, ZI TURBO EXT; '11 F8 EXT
5639-328: BLACK
5639-329: GREEN
5639-330: ORANGE

\$39.95



5639-169

SNOW MESH

- PREVENTS SNOW AND WATER INFILTRATION
- SELF-ADHESIVE SCREENS INSTALL OVER VENTS/OPENINGS
- SCREENS FEATURE A COARSE MESH TO MAXIMIZE AIRFLOW

NOTE: 5639-332 & 5639-352 INCLUDE BUMPER AND CLUTCH VENT SCREENS

BUMPER

5639-332:
'07-'11 F SERIES; '08-'11 T 570, TZI TOURING; '09-'11 BC 570, ZI \$29.95

5639-352:
'09-'10 TZI TURBO TOURING, ZI TURBO \$29.95

5639-169:
'05-'11 M SERIES; '06-'11 CF; '09-'11 CFR, M8 HCR \$24.95

HOOD

5639-458:
'07-'11 F SERIES; '08-'11 TZI TOURING;
'09-'11 BC ZI XT, ZI (NON-TURBO) \$29.95

5639-333:
'05-'11 M SERIES; '06-'11 CF; '09-'11 CFR, M8 HCR \$29.95

5639-396:
'10-'11 SNO PRO 500 \$29.95



5639-458



WEAR STRIPS

- RUGGED, HIGH-DENSITY POLYETHYLENE CONSTRUCTION
- SOLD INDIVIDUALLY

121-IN.-128-IN. MODELS
2604-819: GREEN
2604-289: ORANGE

\$14.95

136-IN.-162-IN. MODELS
2604-821: GREEN
1604-769: ORANGE

\$19.95



HEADLIGHT COVERS

- PROTECTS VALUABLE HEADLIGHTS FROM DAMAGE
- EASY-TO-ATTACH VELCRO FASTENERS
- SOLD IN PAIRS

NOTE: SOME STATES AND REGIONS MAY PROHIBIT THE USE OF COLORED HEADLIGHT COVERS. PLEASE CHECK WITH LOCAL AND STATE LAWS. ARCTIC CAT SALES INC. SHALL NOT BE LIABLE FOR ANY CLAIMS RESULTING FROM THE USE OF ILLEGAL HEADLIGHT COVERS.

'07-'11 F SERIES; '08-'11 T 570, TZI TOURING;
'09-'11 BC, ZI, ZI TURBO
4639-587: GREEN
4639-588: SMOKE

'05-'11 M SERIES; '06-'11 CF; '09-'11 CFR,
M8 HCR
2639-596: GREEN
2639-598: SMOKE

'10-'11 SNO PRO 500
5639-394: GREEN
5639-395: SMOKE

\$42.95



A-ARM DEFLECTORS

- REDUCES SNOW SPRAY
- SOLD IN PAIRS

'07-'11 F SERIES; '08-'11 T 570,
TZI TOURING; '09-'11 ZI, ZI TURBO
4639-897: BLACK
4639-898: GREEN
4639-899: ORANGE

\$24.95



WINDSHIELD MIRRORS

- MOUNTS TO THE OUTSIDE OF THE WINDSHIELD
- PROVIDES A CLEAR VIEW OF THE SITUATION BEHIND YOU
- PURCHASE IN SINGLES OR PAIRS

'07-'11 F SERIES; '08-'11 T 570, TZI TOURING; '09-'11 BC,
ZI, ZI TURBO
4639-733: PAIR \$59.95
4639-734: SINGLE \$29.95



COMPACT MIRRORS

- SMALLER DESIGN MOUNTS TO THE INSIDE OF THE WINDSHIELD
- SOLD INDIVIDUALLY

4639-565: '07-'11 F SERIES; '09-'11 ZI, ZI TURBO
4639-463: '05-'11 M SERIES; '06-'11 CF; '09-'11 CFR,
M8 HCR

\$18.95



HAND MIRROR

- EASILY STRAPS ON/OFF WITH VELCRO
- OPTIMAL REAR VIEW FROM A WIDE, CONVEX LENS

4992-810: \$8.95



Far be it from the untrained eye to see your Arctic Cat snow machine for the tool it really is: A burly workhorse in disguise. And an efficient work partner at that, as evidenced by utility accessories like WARN® winch systems, snowplows and cargo racks, to name just a precious few of the tools readily available. Suddenly, weekend winter chores don't seem all that monotonous, do they?



BEARCAT® GEAR BAG
 -GIANT, TRUCK-STYLE STORAGE
 -MOUNTS EITHER VERTICALLY WITH PASSENGER SEAT OR HORIZONTALLY WITHOUT

5639-049:
 '09-'11 BC XT \$219.95



NEW

TUNNEL PACK
 -MID-CAPACITY STORAGE
 -SECURE, EASY-TO-USE QUICK-FASTEN STRAPS
 -MOUNTS WITH PASSENGER SEAT INSTALLED OR REMOVED

6606-252:
 '09-'11 BC XT \$129.95



5639-499



5639-522

SNOW MESH
 -PREVENTS SNOW AND WATER INFILTRATION
 -INSTALLS OVER INTAKE VENTS/OPENINGS

BUMPER
 5639-522: '09-'11 BC XT \$39.95
 5639-332: '09-'11 BC 570 \$29.95

HOOD
 5639-458: '09-'11 BC ZI XT \$29.95

REAR
 5639-499: '09-'11 BC ZI XT \$12.95



THIRD SEAT
 -SECURES TO REAR RAILS
 -ALLOWS FOR A THIRD PASSENGER
 -EASY TO INSTALL/REMOVE

5639-063:
 '09-'11 BC XT \$179.95

CARGO RACK
 -HEAVY-DUTY STEEL RACK
 -PROVIDES HUGE CARRYING CAPACITY

5639-062:
 '09-'11 BC XT \$279.95



SHORT

SIDE RAILS
 -ADDS CARGO CAPACITY
 -USE SHORT RAIL WHEN PASSENGER SEAT IS INSTALLED, LONG RAIL WHEN SEAT IS REMOVED

'09-'11 BC XT
 5639-060: SHORT \$59.95
 5639-061: LONG \$79.95



LONG



RECEIVER BUMPER

- HEAVY-DUTY FRONT AND REAR BUMPERS FEATURE A 2-IN. RECEIVER HITCH
- RUST-RESISTANT POWDER COATING
- REQUIRED FOR SNOWPLOW OR RECEIVER WINCH

'09-'11 BC XT
5639-339: REAR \$179.95
5639-338: FRONT \$99.95



HITCH

- 2-IN. RECEIVER HITCH INCLUDES PIN AND CLIP
- PINTLE OR PIVOT HITCH NOT INCLUDED

5639-386:
'09-'11 BC XT \$39.95



PIVOT HITCH

- EASILY CONVERTS THE STANDARD PIVOT HITCH TO A PIVOT HITCH

5639-387:
'09-'11 BC XT \$39.95



RECEIVER WINCH

- ARCTIC CAT/WARN® DESIGNED AND ENGINEERED
- CONVENIENT HANDLEBAR-MOUNTED ROCKER SWITCH
- SOLENOID CONTROLLER FOR KEY-ONLY OPERATION
- INCLUDES WINCH, RECEIVER MOUNT, ROLLER FAIRLEAD, SOLENOID, HANDLEBAR SWITCH AND FRONT HARNESS WITH QUICK-DISCONNECT
- INCLUDES 50 FT. OF STEEL CABLE
- 2,500-LB. CAPACITY
- REQUIRES RECEIVER BUMPER

5639-340:
'09-'11 BC XT \$679.95



WINCH ACCESSORIES

WINCH COVER

- PROTECTS WINCH MOTOR WHEN NOT IN USE

5639-459: \$39.95



TRANSPORT MOUNT

- ALLOWS WINCH TO BE CARRIED IN A SECURE, OUT-OF-THE-WAY POSITION
- MOUNTS TO REAR TUNNEL SIDE

5639-457:
'09-'11 BC XT \$39.95



REAR HARNESS

- (NOT SHOWN)
- HARNESS WITH QUICK-DISCONNECT IS REQUIRED WHEN USING RECEIVER WINCH IN REAR BUMPER

5639-456:
'09-'11 BC XT \$89.95

SNOWPLOW PUSH FRAME

- STRONG, HEAVY-DUTY STEEL CONSTRUCTION
- ADJUSTABLE PLOW ANGLE AND CUTTING-EDGE ANGLE
- QUICK-CONNECT SYSTEM FOR EASY INSTALLATION AND DETACHMENT
- RUST-RESISTANT POWDER COATING
- REQUIRES FRONT RECEIVER Bumper AND RECEIVER Winch; BLADE SOLD SEPARATELY

5639-341:
'09-'11 BC XT \$379.95



SNOWPLOW BLADE

- HEAVY-DUTY YET LIGHTWEIGHT CONSTRUCTION FROM HIGH-DENSITY POLYETHYLENE OVER A TOUGH STEEL FRAME
- 60-IN. BLADE WITH ADJUSTABLE SKIDS
- REQUIRES SNOWPLOW Push FRAME Kit

0436-296:
'09-'11 BC XT \$219.95



WARN® PORTABLE WINCH KIT

- BOASTS 1,500 LBS. OF PULLING POWER
- HOOKS TO LOAD QUICKLY DURING FREE-SPOOL MODE
- CUSTOM, DURABLE CANVAS STORAGE BAG INCLUDED
- INCLUDES 50 FT. OF 5/32-IN.-DIAMETER ROPE
- WEIGHS JUST 15 LBS.

4639-138:
MODELS WITH STANDARD BATTERY \$529.95

CARGO SLEDS

- (ADDED FREIGHT CHARGES MAY APPLY)
- RELIABLE, ULTRADURABLE, HIGH-IMPACT, FLEXIBLE POLYETHYLENE
- HEAVY-DUTY SWIVEL HITCH
- HAUL HEAVY LOADS WITH STRAIGHT-TRACKING BOTTOM
- AVAILABLE IN TWO SIZES

4639-125: MEDIUM (65" L x 32" W x 17" D) \$179.95
4639-126: LARGE (74" L x 38" W x 17" D) \$229.95



CARGO SLED COVER

- SNUG, HEAVY-DUTY CANVAS WITH ELASTIC BOTTOM

4639-129:
FITS BOTH MODELS \$54.95



CARGO SLED RUNNER KITS

- PROTECTS BOTTOM WITH BOLT-ON 1/2-IN. PLASTIC RUNNERS
- TRACK TRUE

4639-130: MEDIUM \$69.95
4639-131: LARGE \$89.95



BACKUP LIGHT KIT

- EXCELLENT ILLUMINATION IN A COMPACT (20W) SIZE
- EASILY MOUNTS TO THE REAR OF TUNNEL
- INCLUDES WIRING AND SWITCH
- ACTIVATED BY REVERSE APPLICATION

5639-389:
'09-'11 BC XT \$49.95

PASSENGER HAND WARMERS

- ELECTRICALLY POWERED WARMTH

4639-970:
'09-'11 BC ZI XT \$99.95



SKI SKINS

- ADDED FLOTATION FROM 12-IN.-WIDE SKI SKINS
- FITS 8-IN. SADDLELESS SKIS
- SOLD IN PAIRS; INCLUDES MOUNTING HARDWARE

5639-254:
'09-'11 BC 570,
BC XT \$139.95



SWAY BAR

- FOR IMPROVED CORNERING IN TRAIL CONDITIONS OR ON HARD-PACKED SNOW

5639-441:
'09-'11 BC 570 XT; '10-'11 BC ZI XT

5639-200:
'09-'11 BC 570

\$89.95

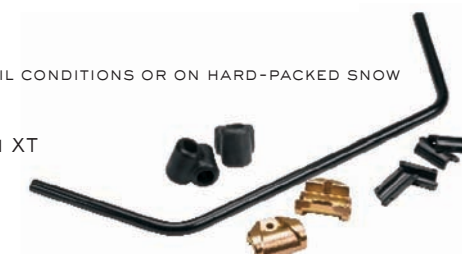

WHEN ORDERING A PLOW SYSTEM, YOU NEED:
RECEIVER BUMPER - RECEIVER WINCH -
SNOWPLOW PUSH FRAME - SNOWPLOW BLADE



MOUNTAIN PACK

- COMPACT, HANDY TOOL/GEAR STORAGE
- QUICK-FASTEN STRAPS ATTACH TO REAR BUMPER

5639-042: '09-'11 M SERIES, M8 HCR, CF, CFR (SHOWN)
3639-725: '05-'08 M SERIES; '06-'08 CF

\$62.95



SPORT GEAR BAG

- HEAVY-DUTY BAG OFFERS GENEROUS CAPACITY
- EASILY INSTALLS WITH QUICK-FASTEN STRAPS

5639-574:
'10-'11 F SERIES, M SERIES, Z1, Z1 TURBO,
Z1 TURBO EXT; '11 F8 EXT \$99.95



MOUNTAIN SEAT BAG

- MID-SIZE GEAR STORAGE
- QUICK-FASTEN STRAPS ATTACH TO REAR BUMPER

5639-043:
'09-'11 M SERIES, M8 HCR, CF, CFR \$109.95



TUNNEL PACK

- MID-CAPACITY STORAGE
- SECURE, EASY-TO-USE QUICK-FASTEN STRAPS

5639-433:
'10-'11 SNO PRO 500, M SERIES, M8 HCR \$99.95



MOUNTAIN GEAR BAG

- LARGE CAPACITY FOR GENEROUS OVERNIGHT STORAGE
- QUICK-FASTEN STRAPS ATTACH TO REAR BUMPER

5639-044:
'09-'11 M SERIES, M8 HCR (SHOWN) \$129.95

4639-727:
'05-'08 M SERIES; '06-'08 CF \$109.95



The backcountry is a challenging environment with endless possibilities — exactly why big mountain riding holds such a powerful fascination for many of us. It's also why the terrain and conditions demand respect and intuitive gear preparation. You'll find smart attention to backcountry details here with performance gear designed with your safety in mind, without sacrificing an ounce of powder-faced fun.



TANK JACKET
 -STYLE WITH ADDED PROTECTION
 -INCLUDES TWO STORAGE POCKETS

'05-'11 M SERIES;
 '09-'11 M8 HCR
 5639-053: BLACK
 5639-054: GREEN
 5639-055: ORANGE

'06-'11 CF; '09-'11 CFR
 5639-056: BLACK
 5639-057: GREEN
 5639-058: ORANGE

\$79.95



TANK PADS

-ESSENTIAL KNEE PROTECTION FOR THOSE WHO GO BIG
 -UNIQUE STYLE, SOLD IN PAIRS

'05-'11 M SERIES; '06-'11 CF; '09-'11 CFR, M8 HCR (SHOWN)
 5639-050: BLACK
 5639-051: GREEN
 5639-052: ORANGE

'10-'11 SNO PRO 500
 5639-612: BLACK

\$39.95

WINDSHIELD BAG

-OFFERS OUT-OF-THE-WAY STORAGE FOR SMALLER ITEMS
 -FITS NEATLY BEHIND WINDSHIELD

4639-428:
 '05-'11 M SERIES; '06-'11 CF; '09-'11 CFR, M8 HCR \$39.95



HANDLEBAR BAG

-CONVENIENTLY HOLDS CAP, CELL PHONE, WALLET, ETC.
 -EASY-ACCESS ZIPPERED TOP FLAP

4639-770:
 '05-'11 M SERIES; '06-'11 CF; '09-'11 BC 570,
 BC XT \$39.95

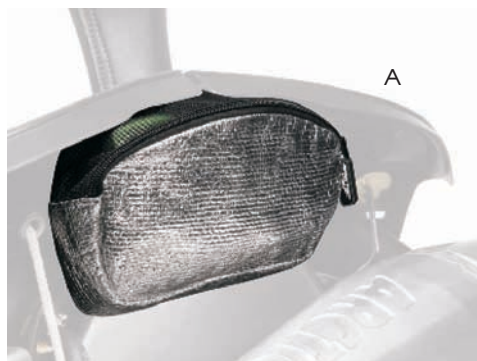

A

GOGGLE HOLDER

-ENGINE HEAT DRIES GOGGLES WHILE YOU RIDE
 -MOUNTS SECURELY UNDER HOOD

NOTE: DO NOT LEAVE GOGGLES IN HOLDER FOR EXTENDED PERIODS. HEAT MAY DAMAGE GOGGLES.

4639-732: A. '05-'11 M SERIES;
 '06-'11 CF; '09-'11 CFR, M8 HCR
 \$34.95



B

5639-342: B. '07-'11 F SERIES;
 '09-'11 TZI TOURING; '09-'11 BC,
 ZI (NON-TURBO) \$19.95



NEW



FLOAT 30™ AVALANCHE AIRBAG

-AFFORDABLE, REUSABLE AND EASY-TO-RELOAD
 BACKCOUNTRY PROTECTION
 -SIMPLY PULL THE T-GRIP TO INFLATE THE 150 LITER AIRBAG TO STAY ON TOP OF THE SNOW SURFACE
 -EXCELLENT PERIPHERAL VISION FROM BEHIND-HEAD INFLATION
 -DOES NOT REPLACE THE NEED FOR AN AVALANCHE BEACON, PROBE, SHOVEL OR SAFETY EDUCATION
 -HYDRATION COMPATIBLE
 -7.4 LBS., 30 LITER CAPACITY

FOR TECH SUPPORT, CONTACT BACKCOUNTRY ACCESS AT 303-417-1345

5639-482: \$699.95

AVALANCHE BEACONS

WHEN FACED WITH AN ON-MOUNTAIN EMERGENCY, THESE EASY-TO-USE AND EFFICIENT BEACONS ARE A NECESSITY AMONG YOUR SUPPLIES



TRACKER DTS™

-REAL-TIME DIGITAL DISPLAY INDICATES DIRECTION AND DISTANCE TO A BURIED RIDER
 -RAPID PROCESSOR AND SIMPLE USER INTERFACE
 -BRIGHT LED LIGHTS MAKE IT EASY TO SEE EVEN IN TOUGH CONDITIONS
 -INCLUDES HARNESS

5639-267: \$289.95

NEW



TRACKER2™

-THE FASTEST, MOST PRECISE PINPOINTING, WITH TRIPLE RECEIVER ANTENNA
 -INSTANTANEOUS REAL-TIME DISPLAY AND EASY-TO-USE INTERFACE
 -AN INTUITIVE SEARCH/TRANSMIT SWITCH MAKES IT EASIER TO USE
 -THINNER PROFILE AND HARNESS THAN TRACKER DTS
 -FEATURES SPECIAL MODE AND MULTIPLE BURIAL INDICATOR LIGHTS
 -INCLUDES HARNESS (NOT SHOWN)

FOR TECH SUPPORT, CONTACT BACKCOUNTRY ACCESS AT 303-417-1345

5639-610: \$334.95



BACKCOUNTRY KIT

-INCLUDES BCA BACKPACK, TOUR SHOVEL, PROFILE 240 PROBE, AND TRACKER DTS AVALANCHE BEACON

5639-440: \$419.95



BCA BACKPACK

- BACKCOUNTRY ACCESS SQUALL BACKPACK
- TOP-LOADING/CLAMSHELL HYBRID
- INTERNAL POCKETS FOR SHOVEL/PROBE
- INTERNAL STUFF SACK WITH SPINDRIFT COLLAR
- HYDRATION COMPATIBLE
- 1.9 LBS., 27 LITER CAPACITY

5639-306: \$69.95



OGIO BACKPACK

- SPECIFICALLY MADE FOR THE ACTIVE RIDER
- HANDY GOGGLE POCKET AND TOOL ORGANIZER PANEL
- OFFERS CONVENIENT SHOVEL STORAGE
- COMFORTABLE STERNUM AND WAIST STRAPS
- HYDRATION COMPATIBLE
- 2.6 LBS., 34 LITER CAPACITY

5639-432: \$79.95



ARSENAL SHOVEL

- SUPERSTRONG 6061 ALUMINUM BLADE WITH TOUGH OVAL SHAFT AND T-GRIP HANDLE
- HIDDEN SNOW/WOOD SAW IS STOWED INSIDE THE GRIP
- EXTENDS UP TO 37 3/4 IN. LONG, 10-IN. X 11-IN. BLADE, 31 OZ.

5639-483: \$89.95



TOUR SHOVEL

- COMPACT, LIGHTWEIGHT 6061 ALUMINUM BLADE WITH TOUGH OVAL SHAFT AND T-GRIP HANDLE
- 25 IN. LONG WITH FIXED-LENGTH HANDLE, 9-IN. X 10-IN. BLADE, 16 OZ.

5639-265: \$39.95

COMPANION SHOVEL

- SUPERSTRONG 6061 ALUMINUM BLADE WITH TOUGH OVAL SHAFT AND T-GRIP HANDLE
- EXTENDS UP TO 31 IN. LONG, 10-IN. X 11-IN. BLADE, 26 OZ.

5639-302: \$54.95



PROFILE 240 PROBE

- HELPS DETERMINE THE EXACT LOCATION OF A RIDER BURIED IN AN AVALANCHE
- USE IN CONJUNCTION WITH A BEACON AND SHOVEL
- CONSTRUCTED OF 7075 ALUMINUM, 8.7 OZ.
- COMPACT, YET EXTENDS TO 7 FEET, 11 INCHES
- COLLAPSES TO LENGTH OF 18 INCHES
- STORAGE BAG INCLUDED

5639-266: \$49.95



POCKET SAW

- HIGH-STRENGTH, HEAT-TREATED STEEL
- RUST-RESISTANT COATING
- RETAINS SHARPNESS
- STORAGE BAG INCLUDED

4639-979: \$34.95



BILLET RACK

- DURABLE BILLET ALUMINUM WITH ANODIZED FINISH
- LOW-PROFILE DESIGN

'09-'11 M SERIES, M8 HCR
5639-597: BLACK
5639-598: SILVER

\$109.95



RACK STRAP

- STRONG, HEAVY-DUTY NYLON STRAPS
- QUICK-RELEASE BUCKLE
- EASILY SECURES GEAR AND GAS CANS

4639-978:
'09-'11 M SERIES, M8 HCR, CF, CFR
(SHOWN) \$26.95

3639-579:
'05-'08 M SERIES; '06-'08 CF \$9.95



MOUNTAIN SEAT

- SHORT, HIGH-RISE DESIGN
- BLOW-MOLDED BASE
- 3 1/2 LBS. LIGHTER

'05-'09 M SERIES; '06-'11 CF; '09-'11 CFR
5639-600: BLACK
5639-601: GREEN
5639-602: ORANGE

\$299.95



M SERIES RACK

- DURABLE, LIGHTWEIGHT ALUMINUM
- SCRATCH-RESISTANT POWDER COATING
- ADJUSTS TO DESIRED SIZE

'09-'11 M SERIES, M8 HCR
4639-975: GREEN
4639-976: ORANGE
4639-977: UNPAINTED

\$49.95



LINER BAG

- A WATER-RESISTANT BAG FOR CLEAN, UNDERSEAT STORAGE

5639-350:
'10-'11 M SERIES, M8 HCR \$29.95

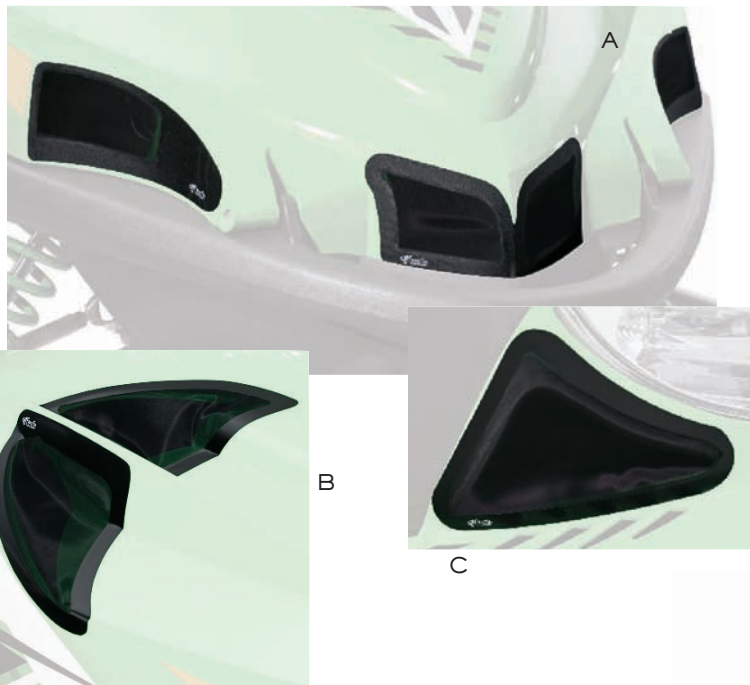

SNOW MESH

- PREVENTS SNOW AND WATER INFILTRATION
- SELF-ADHESIVE SCREENS INSTALL OVER VENT OPENINGS
- 5639-169 & 5639-333 FEATURE A COARSE MESH TO MAXIMIZE AIRFLOW

'05-'11 M SERIES; '06-'11 CF; '09-'11 CFR, M8 HCR

A. BUMPER
5639-169: \$24.95

B. HOOD
5639-333: \$29.95

C. INTAKE
5639-334: \$29.95



ANGLED HANDLEBAR RISERS

- INCREASED COMFORT WHEN STANDING BY SHIFTING BAR POSITION FORWARD
- DURABLE BILLET ALUMINUM WITH ANODIZED FINISH

'05-'11 M SERIES (STD); '06-'11 CF (STD)

5639-503:
2 IN. \$109.95

5639-504:
3 IN. \$119.95



HIGH-TEMP ROLLER KIT

- EXTRA-DURABLE ROLLERS FOR HIGH-HORSEPOWER APPLICATIONS
- SET OF 6

5639-468:
ACT DRIVEN PULLEY \$34.95

HANDLEBAR RISERS

- STRONG, EXTRUDED ALUMINUM
- IMPROVED COMFORT FROM A CUSTOM FIT

'05-'11 M SERIES (STD); '06-'11 CF (STD)

5639-114:
1 IN. \$19.95

5639-115:
2 IN. \$29.95

5639-116:
3 IN. \$39.95



OFFSET RISER

- INCREASED COMFORT WHEN STANDING BY SHIFTING BAR POSITION FORWARD
- DURABLE BILLET ALUMINUM WITH ANODIZED FINISH
- ½ IN. HIGH, 1½ IN. FORWARD

'09-'11 M SERIES, M8 HCR W/ TELESCOPIC STEERING POST
5639-595: BLACK
5639-596: SILVER

\$119.95

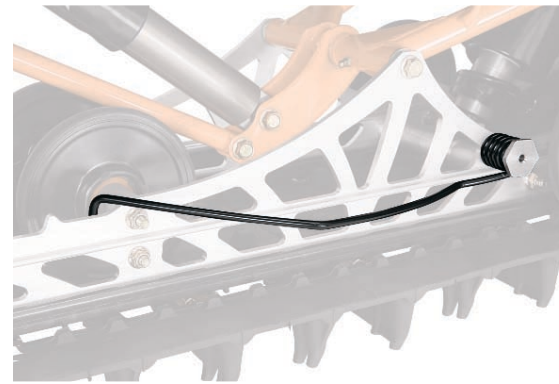

ICE SCRATCHERS

- HELPS PREVENT WEAR STRIP "WEAR" AND OVERHEATING WHEN ON ICE AND HARDPACK
- SOLD IN PAIRS
- USE CAUTION WHEN OPERATING SLED IN REVERSE

4639-958:
'09-'11 M SERIES, M8 HCR, CF \$49.95



FOUR WHEEL KIT

- ADDS TWO INNER WHEELS FOR HEAVY-DUTY USE

5639-528:
'09-'11 M SERIES \$59.95



5639-592

BILLET AXLE WASHERS

- CUSTOM ANODIZED BILLET ALUMINUM
- SOLD IN PAIRS

'09-'11 M SERIES, M8 HCR
5639-591: BLACK
5639-592: SILVER

'09-'11 M SERIES, M8 HCR
5639-243: SILVER
5639-244: GREEN

\$39.95

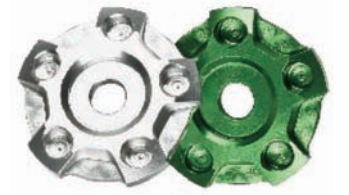

5639-243 5639-244

TWO WHEEL KIT

- PROVIDES IMPROVED TRACTION AND MANEUVERABILITY WHEN SIDEHILLING
- REDUCES WEIGHT BY 1.8 LBS.

4639-997:
'08 M SERIES; '09-'11 CF \$19.95

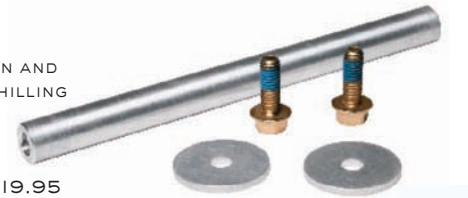



MOUNTAIN STRAP

-FLEXIBLE, CENTER-MOUNT GRAB STRAP FOR AGGRESSIVE RIDING

5639-358:
'10-'11 ZI TURBO EXT; '11 F8 EXT \$39.95

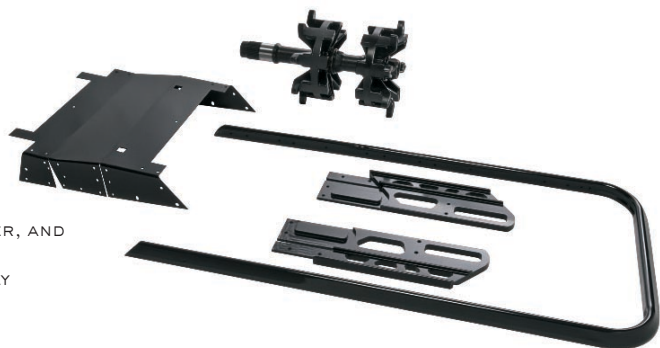

LONG TRACK KIT

-CONVERTS THE EXT TO ACCEPT A 162-IN. TRACK
-INCLUDES TUNNEL/RAIL EXTENSIONS, REAR BUMPER, AND 3.0 PITCH DRIVE SHAFT ASSEMBLY
-POWER CLAW™ (NOTCHED) TRACK SOLD SEPARATELY

5639-360:
'10-'11 ZI TURBO EXT; '11 F8 EXT \$449.95



LIGHTWEIGHT FRONT AXLE KIT

-LONG-WEARING, HARD-ANODIZED ALUMINUM
-1.7 LBS. LIGHTER

4639-995:
'05-'08 M SERIES \$62.95



FLOAT CONVERSION

-CONVERTS TO A SNO PRO-STYLE FLOAT SUSPENSION
-HOLDS LESS SNOW
-8.1 LBS. LIGHTER

4639-994:
'05-'07 M SERIES; '09-'10 CF (STD) \$569.95



TUNNEL FLARES

-PREVENTS SNOW FROM BEING THROWN AT THE RIDER
-ADDS COLOR AND STYLE
-CUT TO DESIRED LENGTH
-SOLD IN PAIRS

'09-'11 M SERIES, M8 HCR, CF, CFR
5639-107: BLACK
5639-108: GREEN
5639-109: ORANGE

\$34.95



EDGE RAILS

-ADDS CUSTOM COLOR AND STYLE
-DURABLE, POWDER-COATED FINISH
-INCLUDES LEFT AND RIGHT TUNNEL EDGES AND GUSSETS

'09-'11 M SERIES, CF, CFR
4639-984: GREEN
4639-985: ORANGE

\$79.95

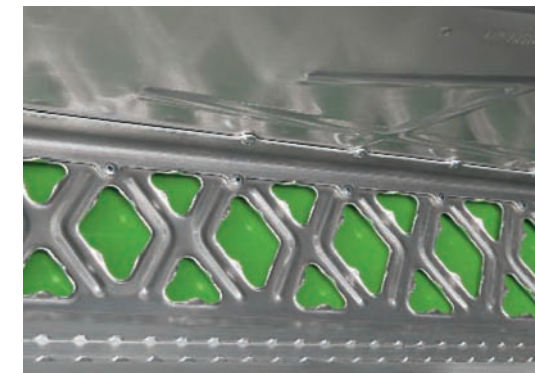

TUNNEL DEFLECTOR

-KEEP FEET DRIER IN SLUSHY CONDITIONS
-DURABLE, POWDER-COATED ALUMINUM PANELS
-SOLD IN PAIRS

'09-'11 M SERIES, M8 HCR, CF
4639-981: GREEN
4639-982: ORANGE
4639-983: UNPAINTED

\$39.95

RACK PAD

-PROTECTS THE TUNNEL WHILE ADDING STYLE
-TRIM TO DESIRED SIZE
-5639-351 FEATURES A FLAT-BOTTOM DESIGN

4639-988:
'09-'11 M SERIES, M8 HCR, CF, CFR (SHOWN)

5639-351:
'10-'11 F SERIES, ZI, ZI TURBO, ZI TURBO EXT; '11 F8 EXT

\$44.95



REAR BUMPER

-ADDS CUSTOM COLOR AND COOLNESS
-SCRATCH-RESISTANT, POWDER-COATED ALUMINUM
-MUST BE CUT TO LENGTH

'09-'11 M SERIES, M8 HCR, CF, CFR
4639-986: GREEN
4639-987: ORANGE

\$49.95

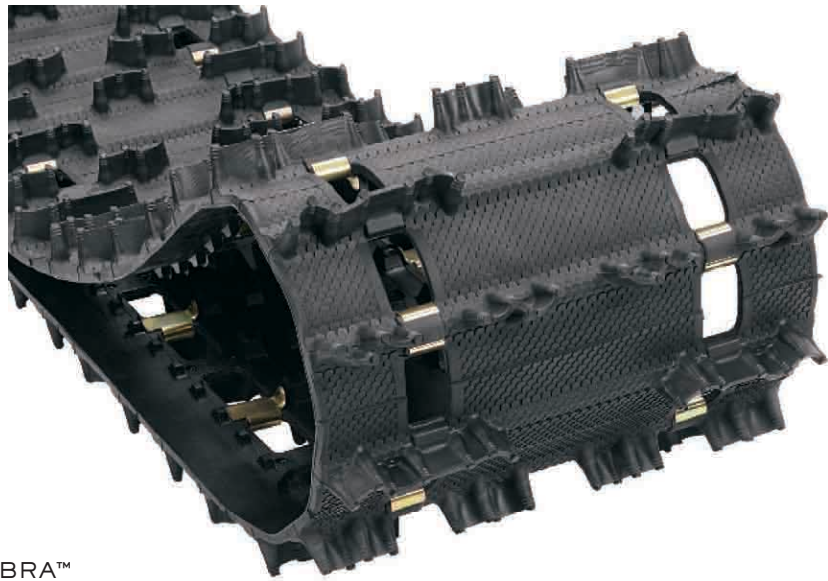
**COBRA™**

- SCALES FOR EXCELLENT TRACTION AND GRIP, WHILE PROVIDING AMPLE FLOAT IN LOOSE SNOW
- OFFERS IMPROVED POWDER PERFORMANCE FROM A UNIQUE LUG SHAPE AND PATTERN
- FREE-WHEELING TRACK FROM SINGLE-PLY TECHNOLOGY REQUIRES MUCH LESS HORSEPOWER

**POWER CLAW**

- PHENOMENAL, LIGHTWEIGHT DEEP POWDER PERFORMANCE FROM A 3.0-IN. PITCH
- EXCELLENT SIDEHILL GRIP FROM 2.25-IN. STAGGER-SET, CURVED FORWARD PADDLE TOWERS
- LONGER USEFUL TRACK LIFE, AS IT WON'T FOLD OVER AND TAKE A SET
- SNOW-CUPPING OUTSIDE PADDLE ANGLES
- FREE-WHEELING TRACK FROM SINGLE-PLY TECHNOLOGY REQUIRES MUCH LESS HORSEPOWER

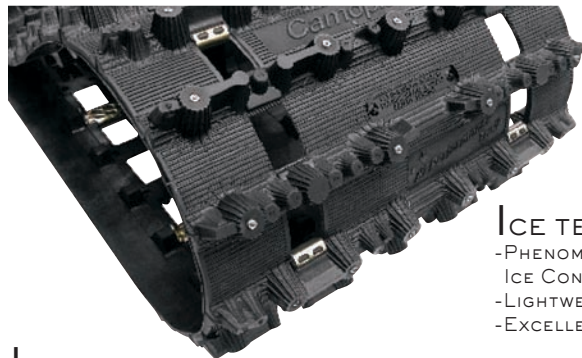
**ICE CLAW™**

- SMOOTHLY ENHANCES TRACTION WITH A 1-INCH PROFILE HEIGHT

**HACKSAW™**

- EXCELLENT ON HARDPACK
- RIPSAW™ DERIVATIVE FEATURES SUPERIOR HANDLING FROM CRESCENT PROFILES
- RECESSED TIPS AND CUTTING EDGES SLICE INTO HARD SNOW

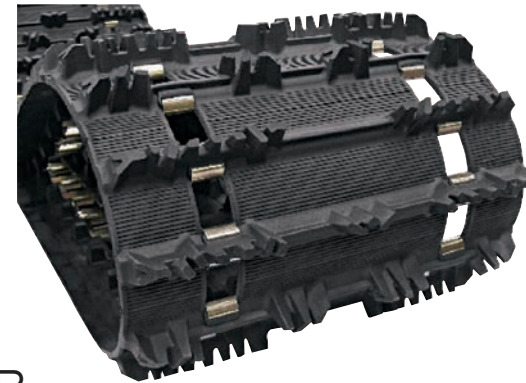
**RIPSAW**

- VERSATILE AND AGGRESSIVE WITH ANGLED PROFILES FOR A WIDE VARIETY OF CONDITIONS
- OUTSTANDING FORWARD AND LATERAL BITE FOR SUPERIOR HANDLING/ACCELERATION

**CHALLENGER™**

- MADE FOR MOUNTAIN SNOW CONDITIONS
- PROVEN, POWDER-PERFORMING DEEP PADDLES

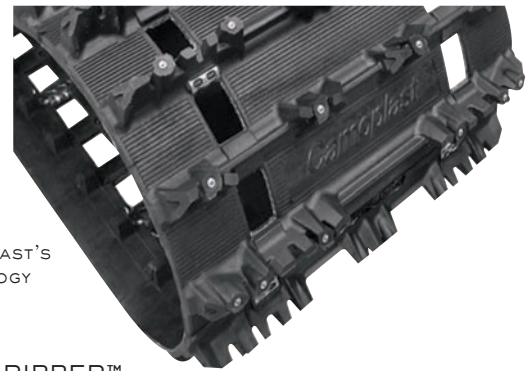
**ICE RIPPER™**

- ULTIMATE CROSSOVER PERFORMANCE FROM FACTORY PRE-STUDDED RIPSAW TRAIL TRACK

| PART # | DIMENSIONS | WT (LB) | CLIPS | PRICE |
|-----------------------------|---|---------|-------------|----------|
| PERFORMANCE (2.52 P) | | | | |
| *1602-976 | 15 IN. X 121 IN. X 1.00 IN. - HACKSAW - 80/70 DURO | 33 | EVERY 3RD | \$599.95 |
| *2602-268 | 15 IN. X 121 IN. X 1.352 IN. - COBRA (SINGLE-PLY) - 80 DURO | 32 | EVERY OTHER | \$649.95 |
| *2602-002 | 15 IN. X 121 IN. X 1.25 IN. - RIPSAW - 80/70 DURO | 36 | EVERY 3RD | \$639.95 |
| *2602-047 | 14 IN. X 128 IN. X 1.00 IN. - HACKSAW - 80/70 DURO | 34 | EVERY 3RD | \$629.95 |
| *2602-019 | 15 IN. X 128 IN. X 1.00 IN. - HACKSAW - 80/70 DURO | 36 | EVERY 3RD | \$629.95 |
| *2602-162 | 15 IN. X 128 IN. X 1.352 IN. - COBRA - 80 DURO | 37 | EVERY OTHER | \$679.95 |
| *2602-255 | 15 IN. X 128 IN. X 1.352 IN. - COBRA (SINGLE-PLY) - 80 DURO | 34 | EVERY 3RD | \$679.95 |
| *2602-046 | 15 IN. X 128 IN. X 1.25 IN. - RIPSAW - 80/70 DURO | 41 | EVERY 3RD | \$679.95 |
| *2602-835 | 15 IN. X 128 IN. X 1.50 IN. - RIPSAW - 80/70 DURO | 42 | EVERY 3RD | \$719.95 |
| *1602-997 | 15 IN. X 136 IN. X 1.25 IN. - RIPSAW - 80/70 DURO | 42 | EVERY 3RD | \$699.95 |
| *2602-005 | 15 IN. X 136 IN. X 1.50 IN. - RIPSAW - 80/70 DURO | 42 | EVERY 3RD | \$759.95 |

TOURING (2.52 P)

| | | | | |
|-----------|--|----|-------------|----------|
| *2602-003 | 15 IN. X 136 IN. X 1.00 IN. - HACKSAW - 80/70 DURO | 37 | EVERY 3RD | \$659.95 |
| *2602-101 | 15 IN. X 144 IN. X 1.00 IN. - HACKSAW - 80/70 DURO | 40 | EVERY 3RD | \$689.95 |
| *2602-163 | 15 IN. X 144 IN. X 1.352 IN. - COBRA - 80 DURO | 41 | EVERY OTHER | \$749.95 |
| *2602-350 | 15 IN. X 144 IN. X 1.50 IN. - CROSSOVER (SINGLE-PLY) - 80 DURO | 47 | EVERY 3RD | \$779.95 |

MOUNTAIN TRACKS (2.52 P)

| | | | | |
|----------|---|----|---------------|----------|
| 2602-069 | 15 IN. X 136 IN. X 2.00 IN. - STYLE J - 80 DURO | 51 | FULLY CLIPPED | \$794.95 |
| 1602-137 | 15 IN. X 144 IN. X 2.00 IN. - CHALLENGER (NOTCHED) - 80/60 DURO | 46 | FULLY CLIPPED | \$896.95 |

MOUNTAIN TRACKS (3.0 P)

| | | | | |
|----------|--|----|-------------|----------|
| 2602-169 | 15 IN. X 141 IN. X 1.352 IN. - COBRA (SINGLE-PLY) - 80 DURO | 38 | EVERY OTHER | \$749.95 |
| 2602-170 | 15 IN. X 141 IN. X 1.60 IN. - COBRA (SINGLE-PLY) - 80 DURO | 40 | EVERY OTHER | \$779.95 |
| 2602-166 | 15 IN. X 141 IN. X 2.25 IN. - POWER CLAW - 80 DURO | 44 | EVERY OTHER | \$919.95 |
| 1602-994 | 15 IN. X 141 IN. X 2.25 IN. - CHALLENGER - 80 DURO | 44 | EVERY OTHER | \$896.95 |
| 2602-167 | 15 IN. X 153 IN. X 2.25 IN. - POWER CLAW - 80 DURO | 48 | EVERY OTHER | \$949.95 |
| 2602-284 | 15 IN. X 153 IN. X 2.25 IN. - POWER CLAW HC - 90 DURO | 48 | EVERY OTHER | \$949.95 |
| 1602-995 | 15 IN. X 153 IN. X 2.25 IN. - CHALLENGER - 80 DURO | 47 | EVERY OTHER | \$929.95 |
| 2602-168 | 15 IN. X 162 IN. X 2.25 IN. - POWER CLAW - 80 DURO | 50 | EVERY OTHER | \$979.95 |
| 2602-367 | 15 IN. X 162 IN. X 2.25 IN. - POWER CLAW (NOTCHED) - 80 DURO | 48 | EVERY OTHER | \$999.95 |
| 1602-996 | 15 IN. X 162 IN. X 2.25 IN. - CHALLENGER - 80 DURO | 50 | EVERY OTHER | \$959.95 |

ICE TECH SERIES (2.52 P)

NOTE: STUD QUANTITY LISTED IN PARENTHESES

| | | | | |
|-----------|--|----|-----------|----------|
| *2602-030 | 15 IN. X 121 IN. X 1.00 IN. - ICE CLAW - 70 DURO (240) | 36 | EVERY 3RD | \$719.95 |
| *2602-032 | 15 IN. X 121 IN. X 1.25 IN. - ICE RIPPER - 70 DURO (258) | 37 | EVERY 3RD | \$799.95 |
| *2602-376 | 15 IN. X 128 IN. X 1.25 IN. - ICE RIPPER - 70 DURO (272) | 39 | EVERY 3RD | \$859.95 |

UTILITY (2.52 P)

| | | | | |
|----------|---|----|---------------|----------|
| 2602-314 | 15 IN. X 151 IN. X 1.25 IN. - RIPSAW (SINGLE-PLY) - 80 DURO | 45 | EVERY 3RD | \$859.95 |
| 0602-935 | 16 IN. X 156 IN. X 1.00 IN. - 60 DURO | 51 | FULLY CLIPPED | \$779.95 |
| 0602-962 | 20 IN. X 156 IN. X 1.00 IN. - 60 DURO | 63 | FULLY CLIPPED | \$859.95 |
| 1602-869 | 20 IN. X 156 IN. X 1.25 IN. - 80 DURO | 67 | FULLY CLIPPED | \$909.95 |

UTILITY (2.86 P)

| | | | | |
|----------|--|----|-----------|----------|
| 2602-358 | 20 IN. X 154 IN. X 1.375 IN. - (SINGLE-PLY) - 80/70 DURO | 58 | EVERY 3RD | \$949.95 |
|----------|--|----|-----------|----------|

*ACT QUIET TRACKS ARE FOR USE ON '03-'11 MODELS ONLY.

TRACKS LISTED ARE REQUIRED FOR USE ON '07-'11 MODELS WITH ACT DRIVE AND REVERSE. WILL ALSO FIT OLDER MODELS.

ALL TRACKS LISTED FEATURE AN "ALL OPEN" WINDOW CONFIGURATION.





Working in tandem with the equally driven staff at leading companies like Woody's® and Stud Boy®, Arctic Cat engineers have developed ultraeffective traction products that keep your sled handling intuitively at speed and firmly attached to the ground.

STUD PLACEMENT

- DO NOT USE STUDS THAT ARE LONGER THAN RECOMMENDED
- DO NOT PLACE STUDS IN LINE WITH THE HEAT EXCHANGER OR TUNNEL PROTECTOR STRIP AND FACTOR IN THE AMOUNT OF SUSPENSION TRAVEL TO AVOID TUNNEL DAMAGE
- STUDS MUST NOT EXTEND MORE THAN 3/8 IN. BEYOND THE RUBBER TRACK LUGS
- VERIFY ADEQUATE CLEARANCE BETWEEN THE TRACK, TUNNEL AND HEAT EXCHANGER TO AVOID SERIOUS DAMAGE
- CONFIRM THAT YOUR MACHINE HAS ADEQUATE TUNNEL PROTECTION BEFORE INSTALLING STUDS
- USE ONLY ARCTIC CAT-APPROVED STUD TEMPLATES SHOWN ON PAGE 129
- THE LENGTH OF CARBIDE AND NUMBER OF STUDS MUST COORDINATE TO RESULT IN BALANCED HANDLING AND PROPER CONTROL

CAUTION

- TO PROTECT THE TUNNEL FROM POSSIBLE DAMAGE FROM THE STUDS, IT IS RECOMMENDED THAT A TUNNEL PROTECTOR KIT BE INSTALLED ON THOSE MODELS NOT SO EQUIPPED
- A SHORT SNOWFLAP IS REQUIRED WHEN INSTALLING STUDS ON '07-'09 F SERIES, Z1; '09-'11 CROSSFIRE AND CFR

SEE YOUR DEALER

MAXIMIZE HANDLING & CONTROL

STEERING CONTROL

THE LENGTH OF THE TURNING CARBIDE (CARBIDE INSERTED DIRECTLY UNDER THE STEERING SPINDLE) IS THE DETERMINING FACTOR ON STEERING CONTROL. THE LONGER THE TURNING CARBIDE, THE MORE POSITIVE TURNING BECOMES. TOO FEW STUDS WITH LONG TURNING CARBIDES CAN RESULT IN THE SITUATION SHOWN IN ILLUSTRATION 1 BELOW.

TRACTION CONTROL

THE QUANTITY AND TYPES OF STUDS INSERTED THROUGH THE TRACK CAN HAVE SEVERAL EFFECTS. IF INSTALLED IMPROPERLY, TRACK AND/OR STUD DAMAGE CAN RESULT. IF THE PUSHING FORCE FROM AN EXCESSIVE NUMBER OF STUDS EXCEEDS THE ABILITY OF THE STEERING TO CONTROL THE FORCE, THE EFFECT COULD BE LIKE THAT IN ILLUSTRATION 2. IN THIS CASE, THE STUDS TEND TO "PUSH" THE SKIS IN A STRAIGHT LINE.

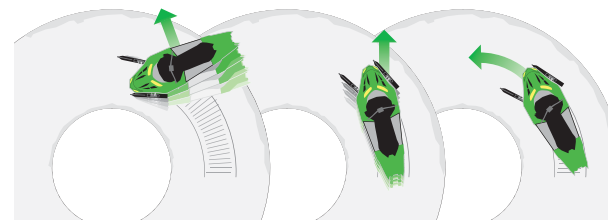

1. BACK END LOOSE. TOO MUCH CARBIDE, NOT ENOUGH STEERING CONTROL.

2. FRONT END PUSHES. WEAK STEERING FROM WORN WEARBARS, TURNING CARBIDES TOO SHORT OR OVERSTUDDING ON TRACK.

3. STEERING CONTROL AND STUD QUANTITY ARE IN BALANCE FOR PROPER SETUP.



TUNE YOUR SLED'S HANDLING TO YOUR RIDING STYLE

DETERMINING THE PROPER TRACTION AND CONTROL IS SIMPLE. WHAT'S YOUR RIDING STYLE: A CONSERVATIVE TRAIL RIDER OR A PERFORMANCE TRAIL RIDER? LOOK AT THE CHART BELOW. FIND THE LINE WITH THE HORSEPOWER OF YOUR SLED. LOOK UNDER YOUR RIDING CATEGORY. HERE YOU WILL DISCOVER THE NUMBER OF STUDS AND THE LENGTH OF THE CARBIDE WEARBAR YOU SHOULD USE. THIS IS A BASELINE GUIDE FOR STUD AND WEARBAR SELECTION.

SEE YOUR DEALER FOR SPECIFIC MODEL APPLICATIONS.

| SLED | STUD QUANTITY/ INCHES OF TURNING CARBIDE | | PERFORMANCE |
|------------|---|-------------|-------------|
| | TRAIL | PERFORMANCE | |
| 50-75 HP | 48/4 IN. | 48/6 IN. | 48/6 IN. |
| 75-125 HP | 102/6 IN. | 102/6 IN. | 153/8 IN. |
| 125-150 HP | 153/8 IN. | 153/8 IN. | 153/10 IN. |
| 150-170 HP | 153/8 IN. | 153/8 IN. | 153/10 IN. |

FOR STUD PLACEMENT, USE ONLY ARCTIC CAT-APPROVED STUD TEMPLATES SHOWN ON PAGE 129.

ARCTIC CAT TRACTION PRODUCTS ARE AVAILABLE IN PACKAGE QUANTITIES OF 102 AND 153. THESE QUANTITIES WILL GIVE YOU THE BEST COMBINATIONS FOR BOTH 121-IN. AND 128-IN. TRACKS.

| TRACK LUG HEIGHT | RECOMMENDED STUD LENGTH (IN.) | |
|---------------------|-------------------------------|-------------------------|
| | WOODY'S STUD LENGTH | STUD BOY STUD LENGTH |
| 1.000 | 1.075 | 1.080 |
| 1.250 | 1.325 | 1.375 |
| 1.352 | 1.325 | 1.375 |
| 1.375 | 1.450 | 1.500 |

FOR STUD LENGTH 1.325 IN. AND LONGER, WE RECOMMEND THE USE OF A BIG NUT (PG. 127) OR POWER TOWER SUPPORT NUT (PG. 129).

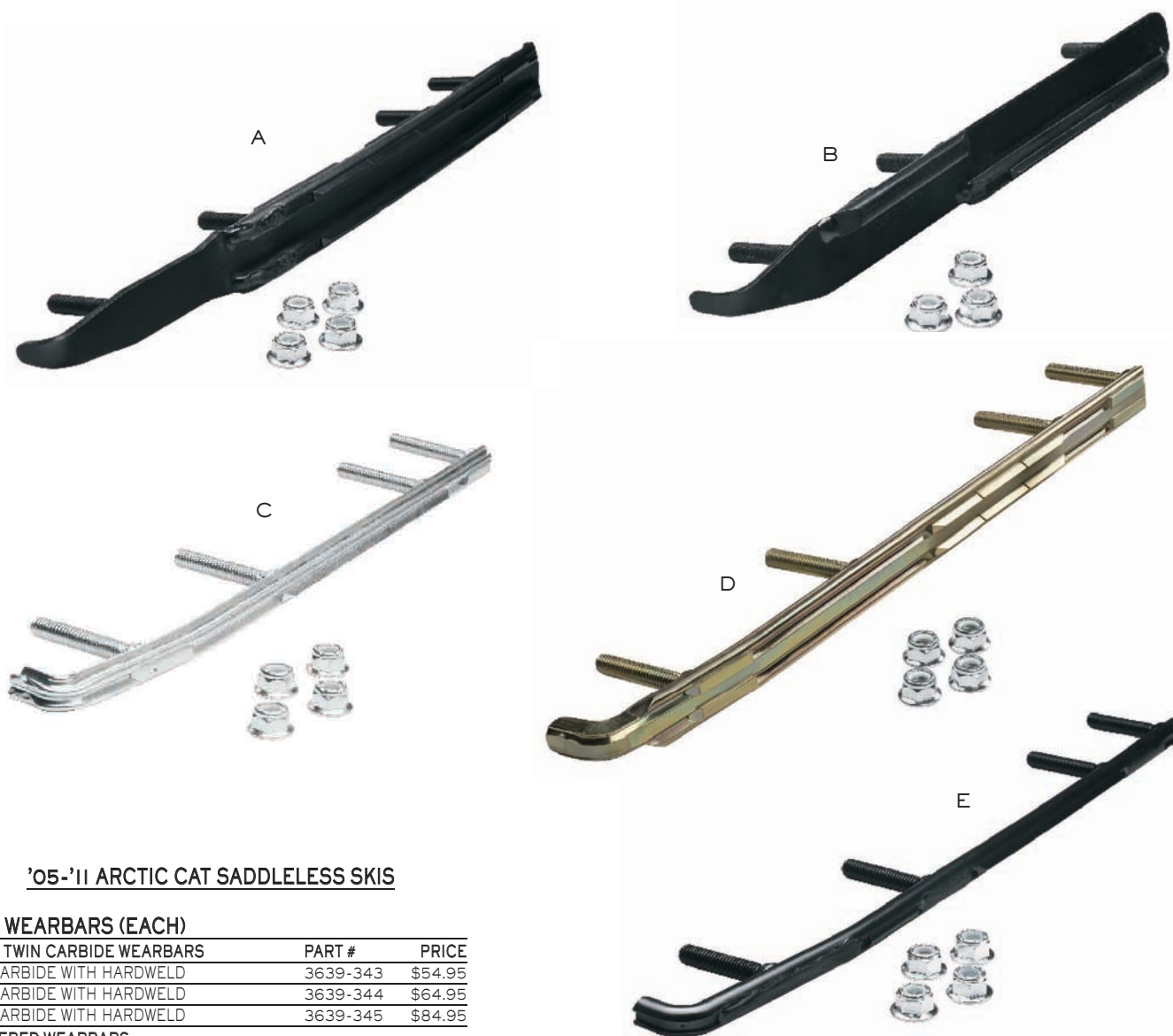

'05-'11 ARCTIC CAT SADDLELESS SKIS

DUAL WEARBARS (EACH)

| DOOLY TWIN CARBIDE WEARBARS | PART # | PRICE |
|-----------------------------|----------|---------|
| 4-IN. CARBIDE WITH HARDWELD | 3639-343 | \$54.95 |
| 6-IN. CARBIDE WITH HARDWELD | 3639-344 | \$64.95 |
| 8-IN. CARBIDE WITH HARDWELD | 3639-345 | \$84.95 |

STAGGERED WEARBARS

| | | |
|--------------------|----------|---------|
| 4-IN. CARBIDE (RH) | 1703-478 | \$44.95 |
| 4-IN. CARBIDE (LH) | 1703-479 | \$44.95 |

DEUCE TWIN CARBIDE WEARBARS

| | | |
|-------------------------------|----------|---------|
| 4.5-IN. CARBIDE WITH HARDWELD | 5639-251 | \$54.95 |
| 6-IN. CARBIDE WITH HARDWELD | 5639-252 | \$64.95 |
| 9-IN. CARBIDE WITH HARDWELD | 5639-253 | \$86.95 |

SHAPER WEARBARS (PAIR)

| | | |
|-----------------|----------|----------|
| 4.5-IN. CARBIDE | 4639-949 | \$79.95 |
| 6-IN. CARBIDE | 4639-950 | \$89.95 |
| 9-IN. CARBIDE | 4639-951 | \$109.95 |

STANDARD WEARBARS (PAIR)

| HARDWELD WEARBAR | | |
|----------------------------------|----------|----------|
| 7/16-IN.-DIAMETER ROUND HOST BAR | 3639-309 | \$26.95 |
| 1/2-IN.-DIAMETER ROUND HOST BAR | | |
| 4-IN. CARBIDE WITH HARDWELD | 3639-310 | \$54.95 |
| 6-IN. CARBIDE WITH HARDWELD | 3639-311 | \$69.95 |
| 8-IN. CARBIDE WITH HARDWELD | 3639-312 | \$89.95 |
| 10-IN. CARBIDE WITH HARDWELD | 3639-313 | \$119.95 |
| 5/8-IN.-DIAMETER ROUND HOST BAR | | |
| 8-IN. CARBIDE WITH HARDWELD | 3639-314 | \$94.95 |
| 10-IN. CARBIDE WITHOUT HARDWELD | 3639-315 | \$119.95 |

NOTE: THE ACCESSORY WEARBARS LISTED ABOVE USE A 4-BOLT STUD PATTERN. WHEN USING ACCESSORY WEARBARS ON '05-'11 MODELS WITH SADDLELESS SKIS AND A 3-BOLT STUD PATTERN, IT WILL BE NECESSARY TO DRILL ANOTHER MOUNTING HOLE IN THE SKI.

WEARBARS

A. DOOLY™ TWIN

- GREAT, ALL-TRAIL PERFORMANCE
- REDUCES DARTING
- FEATURES TWO CARBIDE RUNNERS MOUNTED AS A UNIT
- SOLD INDIVIDUALLY

B. STAGGERED

- GIVES PRECISE CONTROL IN ANY CONDITION
- REDUCES DARTING AND PLUGGING
- SOLD INDIVIDUALLY

C. SHAPER™

- OFFERS MORE PRECISE TURNING THAN CONVENTIONAL WEARBARS
- 20% LIGHTER THAN ROUND WEARBARS
- SOLD IN PAIRS

D. DEUCE™

- THE BEST-PERFORMING DUAL RUNNER AVAILABLE
- REDUCES DARTING AND ELIMINATES DUAL-RUNNER-TYPE DRAG
- DURABLE ONE-PIECE DESIGN
- SOLD INDIVIDUALLY

E. STANDARD

- IDEAL ON ICE AND HARDPACK, BUT WORKS WELL ANYWHERE
- MAY PROVIDE A NOTED SPEED INCREASE COMPARED TO A DUAL OR SHAPER WEARBAR
- SOLD IN PAIRS

2010-2011 MODELS

SINGLE-PLY TRACKS

- BEARCAT 570
- '11 BEARCAT 570 XT, ZI XT
- CROSSFIRE
- CROSSFIRE SNO PRO
- '10 SNO PRO 500

2-PLY TRACKS

- '10 BEARCAT 570 XT, ZI XT
- CFR
- F SERIES (STD), LXR, SNO PRO
- T 570, TZI TOURING
- TZI TURBO TOURING
- ZI (STD), LXR
- ZI TURBO (STD), LXR, SNO PRO
- '11 SNO PRO 500

SINGLE-PLY TRACK APPLICATION WARNING

WHEN INSTALLING STUDS ON A SINGLE-PLY TRACK, IT IS IMPORTANT TO USE ARCTIC CAT-APPROVED STUDS AND BACKER PLATES WITH THE PROPER DIAMETER. IF APPROVED STUDS AND BACKER PLATES ARE NOT USED, STUDS COULD TEAR FREE OF THE TRACK CAUSING POSSIBLE INJURY OR EVEN DEATH.



A. GRAND MASTER™ (SINGLE-PLY) TRACTION KITS

- STUDS FEATURE A LARGER HEAD DESIGN REQUIRED FOR USE ON MODELS WITH A SINGLE-PLY TRACK
- INCLUDES STUDS, SUPPORT PLATES, BIG NUTS, TEMPLATE, DRILL AND TRACK MARKER
- 60° CARBIDE, 5/16-IN. THREAD, 1.20-IN. HEAD, 1.50-IN. SUPPORT PLATES

'09 F SERIES SNO PRO, ZI TURBO LXR & SNO PRO; '10 SNO PRO 500 128-IN. X 1.25-IN. (1.325-IN. STUDS)

5639-230: 102/PK \$369.95
5639-231: 153/PK \$549.95

'09-'11 CF 141-IN. X 1.25-IN. (1.325-IN. STUDS)

5639-144: 94/PK \$349.95

B. SIGNATURE SERIES™ STAINLESS STEEL (2-PLY) 60° CARBIDE, 5/16-IN. THREAD, 15/16-IN. HEAD

- WOODY'S PROVEN PUSH-THROUGH STAINLESS STEEL STUD AT A COMPETITIVE PRICE

C. GOLD DIGGER® TRACTION MASTER® (2-PLY) 60° CARBIDE, 5/16-IN. THREAD, 1-IN. HEAD

- THE INDUSTRY-LEADER AND BEST-SELLING TRAIL STUD
- OUTSTANDING PENETRATION AND DURABILITY ON ICE AND HARDPACK FROM A 60° CARBIDE TIP

SIGNATURE SERIES (2-PLY) TRACTION KITS

- INCLUDES STUDS, SUPPORT PLATES, STANDARD OR BIG NUTS, TEMPLATE, STUD DRILL AND TRACK MARKER

'07-'11 F SERIES; '09-'11 CFR, ZI; '11 SNO PRO 500 128-IN. X 1.00-IN. (1.075-IN. STUDS)

4639-550: 102/PK \$219.95
4639-551: 153/PK \$314.95



D. BIG NUT

- HEAVY-DUTY, LIGHTWEIGHT ALUMINUM
- STRONGER AND MORE SUPPORTIVE THAN STANDARD LOCK NUTS
- RECOMMENDED WHEN USING STUDS 1.325 IN. AND LONGER

SEE YOUR DEALER FOR SPECIFIC PART NUMBERS AND APPLICATIONS

WOODY'S® LIMITED WARRANTY

INTERNATIONAL ENGINEERING & MANUFACTURING, INC. WARRANTS EACH PRODUCT MANUFACTURED BY IT TO BE FREE FROM DEFECTS IN MATERIAL AND WORKMANSHIP UNDER USE FOR THE PURPOSE FOR WHICH IT IS INTENDED. THE COMPANY SHALL NOT BE LIABLE FOR DAMAGE OR DELAYS CAUSED BY DEFECTIVE MATERIALS OR WORKMANSHIP; IS LIMITED TO THE REPAIR OR REPLACEMENT AT ITS FACTORY OF DEFECTIVE ARTICLE OR PART THEREOF, WHICH MAY BE RETURNED TO THE FACTORY, TRANSPORTATION CHARGES, PREPAID WITHIN ONE (1) YEAR AFTER DELIVERY TO THE ORIGINAL PURCHASER. PROOF OF PURCHASE IS ALSO REQUIRED. THE COMPANY SHALL BE THE SOLE JUDGE OF THE EXISTENCE OF ANY DEFECT IN THE ARTICLE SO RETURNED. NO CLAIMS FOR CHARGES INCURRED IN THE REMOVAL, DISASSEMBLY OR REINSTALLATION OF SUCH ARTICLE SHALL BE ALLOWED. PRODUCT MANUFACTURED FOR CONSUMER USE ON SNOWMOBILES IS DESIGNED FOR SNOW OR ICE ONLY; USE ON ANY OTHER SURFACE VOIDS WARRANTY.

THIS WARRANTY SHALL NOT COVER ANY ARTICLE WHICH HAS BEEN MISUSED OR NEGLECTED OR DAMAGED BY ACCIDENT OR ANY ARTICLE WHICH HAS BEEN ALTERED OUTSIDE THE COMPANY'S FACTORY. THE WARRANTY FOR STUDS IS VOID UNLESS THE STUDS ARE INSTALLED WITH WOODY'S INSTALLATION TOOLS, SUPPORT PLATES AND LOCK NUTS; ACCORDING TO THE RECOMMENDATIONS SET FORTH IN WOODY'S INSTRUCTIONS AND TEMPLATE PATTERNS. THIS WARRANTY DOES NOT COVER BENDING, CHIPPING, FLAKING OR CARBIDE PIN BREAKAGE OR PIN LOSS FROM STUD WEAR, STUD REPLACEMENT LABOR OR SHIPPING.

THE COMPANY SHALL, IN NO EVENT, BE LIABLE FOR CONSEQUENTIAL DAMAGE OR CONTINGENT LIABILITY ARISING OUT OF ANY TOTAL OR PARTIAL FAILURE TO FUNCTION OF ANY ARTICLE MANUFACTURED BY IT OR OF ANY EQUIPMENT ON OR IN WHICH IT IS USED. FAILURE OF A USER TO GIVE NOTICE TO CLAIM AS TO DEFECT CLAIMED UNDER THE PROVISIONS OF THE WARRANTY WITHIN ONE (1) YEAR AFTER DELIVERY TO ORIGINAL USE, SUCH CLAIM SHALL CONSTITUTE A WAIVER BY CONSUMER OF ALL CLAIMS WITH RESPECT TO GOODS AND EQUIPMENT.

NO EXPRESS, IMPLIED, OR STATUTORY WARRANTY OTHER THAN THAT HEREIN SET FORTH IS MADE OR AUTHORIZED TO BE MADE BY THE COMPANY. ALL RETURNED WARRANTIES WILL NOT BE ACCEPTED WITHOUT A RETURN AUTHORIZATION NUMBER.

WOODY'S MANUFACTURER WARRANTY RETURNS

CALL OUR CUSTOMER SERVICE DEPARTMENT FOR A RETURN AUTHORIZATION NUMBER. THIS NUMBER MUST BE VISIBLE ON THE OUTSIDE OF THE BOX. THE PRODUCT MUST BE INSPECTED BY A WOODY'S TECHNICIAN TO DETERMINE IF THE PRODUCT IS DEFECTIVE DUE TO MATERIAL, QUALITY OR WORKMANSHIP BEFORE A FINAL WARRANTY DETERMINATION IS MADE. PROOF OF PURCHASE IS REQUIRED. ALL RETURNS TO THE MANUFACTURER ARE FOR EXCHANGE ONLY.



DIGGER (2-PLY) SUPPORT PLATES
 -LIGHTWEIGHT ALUMINUM OFFERS SERIOUS SUPPORT
 -ADDED STRENGTH FROM CROWNED PROFILE
 -1.250-IN. SQUARE, 1.375-IN. ROUND



DOUBLE DIGGER™ (2-PLY) SUPPORT PLATES
 -UNMATCHED SUPPORT FROM DURABLE ALUMINUM



DIGGER (2-PLY) COLORED SUPPORT PLATES
 -RUGGED, POWDER-COATED ALUMINUM
 -1.250-IN.



DOUBLE DIGGER (2-PLY) COLORED SUPPORT PLATES
 -RUGGED, POWDER-COATED ALUMINUM

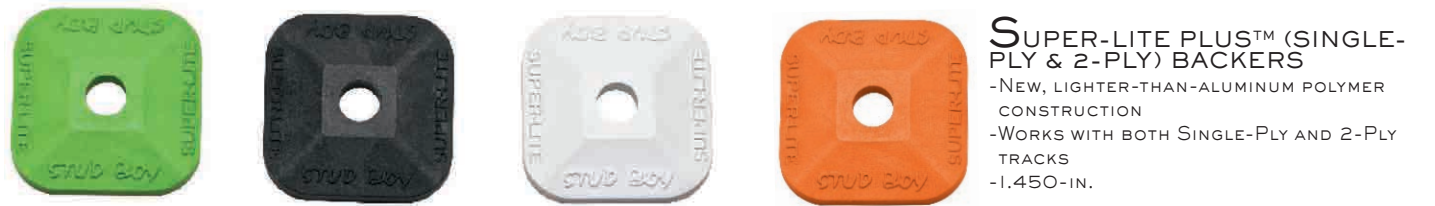

SUPER-LITE PLUS (SINGLE-PLY) DOUBLE BACKERS
 -FOR SINGLE-PLY TRACKS USING STUDS WITH LARGE HEADS LIKE OUR "POWER POINT PLUS" STUD



SUPER-LITE PLUS™ (SINGLE-PLY & 2-PLY) BACKERS
 -NEW, LIGHTER-THAN-ALUMINUM POLYMER CONSTRUCTION
 -WORKS WITH BOTH SINGLE-PLY AND 2-PLY TRACKS
 -1.450-IN.



POWER PLATE™ (2-PLY) BACKERS
 -INNOVATIVE, NEARLY UNBENDABLE DESIGN
 -EXCELLENT STUD SUPPORT
 -1.270-IN.



POWER TOWER SUPPORT NUTS
 -LIGHTWEIGHT, DURABLE STUD SUPPORT
 -RECOMMENDED WHEN USING STUDS 1.375 IN. AND LONGER

STUD DRILL
 -CUTS CLEAN FOR EFFICIENT, PERFECT CUTTING

1639-629: \$10.95



TRACK MARKER
 -ENSURES TRACK PATTERN ALIGNS PERFECTLY WITH STUD TEMPLATE

1639-520: \$7.95



ARCTIC CAT TRACTION BY STUD BOY

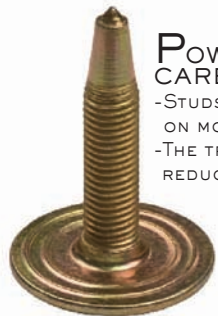

POWER POINT PLUS™ (SINGLE-PLY) 60° CARBIDE, 5/16-IN. THREAD, 1.16-IN. HEAD
 -STUDS FEATURE A LARGER HEAD DESIGN REQUIRED FOR USE ON MODELS WITH A SINGLE-PLY TRACK
 -THE TRACK-TRAPPING DESIGN AND CHAMFERED HEAD REDUCES VIBRATION AND IDLER WHEEL WEAR



POWER PLATE PLUS™ (SINGLE-PLY) BACKERS
 -THE LIGHTWEIGHT AND DURABLE SHAPE FEATURES AN INNOVATIVE DESIGN FOR STUD SUPPORT
 -REDUCES WEAR AND TEAR ON TRACKS, AND RECEIVES THE BEST BENEFITS OF BOTH SQUARE AND ROUND BACKERS
 -REQUIRED FOR USE WITH POWER POINT PLUS STUDS
 -1.375-IN.



POWER POINT™ (2-PLY) 60° CARBIDE, 5/16-IN. THREAD, 1-IN. HEAD
 -OFFERS LIGHTWEIGHT PERFORMANCE
 -EXCELLENT DURABILITY
 -TRACK-TRAPPING HEAD DESIGN



POWER POINT PLUS (SINGLE-PLY) TRACTION KITS

-STUDS FEATURE A LARGER HEAD DESIGN REQUIRED FOR USE ON MODELS WITH A SINGLE-PLY TRACK
 -INCLUDES STUDS, SUPPORT PLATES, POWER TOWER NUTS, TEMPLATE, DRILL AND TRACK MARKER
 -60° CARBIDE, 5/16-IN. THREAD, 1.16-IN. HEAD, 1.375-IN. SUPPORT PLATES

'09 F SERIES SNO PRO, ZI TURBO LXR & SNO PRO; '10 SNO PRO 500 128-IN. X 1.25-IN. SINGLE-PLY TRACK (1.375-IN. STUDS)
 5639-101: 102/PK \$369.95
 5639-102: 153/PK \$549.95

'09-'11 CF 141-IN. X 1.25-IN. SINGLE-PLY TRACK (1.375-IN. STUDS)
 5639-167: 94/PK \$349.95

POWER POINT (2-PLY) TRACTION KITS

-INCLUDES STUDS, SUPPORT PLATES, STANDARD OR TALL NUTS, TEMPLATE, DRILL AND TRACK MARKER

'07-'11 F SERIES; '09-'11 CFR, ZI; '11 SNO PRO 500 128-IN. X 1.00-IN. TRACK (1.080-IN. STUDS)
 5639-099: 102/PK \$289.95
 5639-100: 153/PK \$412.95

'09 BC 570; '08-'11 T 570, TZI 144-IN. X 1.00-IN. TRACK (1.080-IN. STUDS)
 5639-146: 114/PK \$319.95

| Model | Part No. | Qty | Price | Total |
|----------------------------|----------|-----|----------|-------------|
| '07-'11 F Series | 5639-101 | 102 | \$369.95 | \$37,734.90 |
| '07-'11 F Series | 5639-102 | 153 | \$549.95 | \$84,142.35 |
| '09-'11 CF 141-In. | 5639-167 | 94 | \$349.95 | \$32,915.30 |
| '09 BC 570 | 5639-146 | 114 | \$319.95 | \$36,474.30 |
| '08-'11 T 570, TZI 144-In. | 5639-146 | 114 | \$319.95 | \$36,474.30 |

TUNNEL PROTECTOR KIT

-REQUIRED WHEN INSTALLING STUDS ON MODELS LISTED BELOW

4639-968: '09-'11 CF, CFR \$59.95
 4639-771: '08-'11 F 570, T 570;
 '09-'11 BC 570 \$26.95
 5639-143: '09-'11 BC ZI XT \$17.95



SHORT SNOWFLAP

-REQUIRED WHEN INSTALLING STUDS ON MODELS LISTED BELOW

5639-232: '09-'11 CF \$49.95
 4706-462: '07-'09 F SERIES;
 '09 ZI, ZI TURBO \$39.95



STUD BOY LIMITED WARRANTY

LIBERTY PRODUCTS, INC. WARRANTS EACH PRODUCT MANUFACTURED BY IT TO BE FREE OF DEFECTS IN WORKMANSHIP AND MATERIAL WHILE USED FOR THE PURPOSE FOR WHICH IT IS DESIGNED. LIBERTY PRODUCTS, INC. SHALL NOT BE LIABLE FOR DAMAGES OR DELAYS AS A RESULT OF DEFECTS CAUSED BY DEFECTIVE WORKMANSHIP OR MATERIALS. WARRANTY IS LIMITED TO THE REPAIR OR REPLACEMENT AT LIBERTY PRODUCTS OF ANY DEFECTIVE PART OR PRODUCT, WITHIN ONE (1) YEAR OF THE DELIVERY TO THE ORIGINAL PURCHASER, PROOF OF PURCHASE MUST ACCOMPANY THE PRODUCT RETURNED (FREIGHT PREPAID). LIBERTY PRODUCTS, INC. SHALL BE THE SOLE JUDGE OF ANY DEFECT, WHICH MIGHT BE CLAIMED ON THE RETURNED PRODUCT. NO OTHER CHARGES MAY BE CLAIMED IN CONJUNCTION WITH THE REMOVAL, REINSTALLATION OF SUCH PRODUCT. THESE PRODUCTS ARE DESIGNED AND MANUFACTURED FOR USE ON SNOWMOBILES ON SNOW AND ICE ONLY. USE ON OTHER SURFACES VOIDS WARRANTY. WARRANTY WILL BE VOID IF PRODUCT HAS BEEN MISUSED, NEGLECTED, DAMAGED OR MODIFIED OUTSIDE OF LIBERTY PRODUCTS, INC. DOES NOT COVER BENDING, CHIPPING, FLAKING OR CARBIDE BREAKAGE OR LOSS FROM WEAR. LIBERTY PRODUCTS, INC. WILL NOT BE LIABLE FOR CONSEQUENTIAL DAMAGE OR CONTINGENT LIABILITY ARISING FROM ANY TOTAL OR PARTIAL FAILURE TO FUNCTION OF ANY PRODUCT MANUFACTURED BY IT OR ANY EQUIPMENT ON OR IN WHICH IT IS USED. NO FURTHER WARRANTY OF ANY TYPE IS INTENDED OR IMPLIED OR WILL BE AUTHORIZED TO BE MADE BY LIBERTY PRODUCTS, INC.

—OUR MANUFACTURER'S SUGGESTED RETAIL PRICES EXCLUDE FREIGHT, HANDLING AND INSTALLATION. PRICES, PACKAGE QUANTITIES, SPECIFICATIONS AND MATERIALS MAY CHANGE WITHOUT NOTICE—

Maintain your Cat properly, and it'll live a long, productive life. Specifically when you fill it with oil products specially formulated for both Arctic Cat high-performance and classic engines. Field-tested over a diverse range of conditions, our oil and oil products are formulated with only premium base stocks and additives, giving you superior lubrication and rust and corrosion protection.

For an extensive rundown of Arctic Cat lubricants ideally suited for your machine, visit arcticcatlubricants.com



ARCTIC CAT APV SYNTHETIC OIL

Our APV™ Synthetic Oil stands alone as the best, most performance-oriented lubrication you could possibly put through your sled. Given your commitment to the highest level of riding possible, the best oil for the dollar guarantees flawless engine operation.

- THE ULTIMATE IN PERFORMANCE OIL FOR ARCTIC POWER VALVE™ ENGINES AND ALL ARCTIC CAT 2-CYCLE ENGINES
- PROTECTS AGAINST ENGINE WEAR WITH EXCELLENT LUBRICITY
- INCREASES EFFICIENCY AND MAINTAINS ARCTIC POWER VALVE CLEANLINESS
- SMOKELESS FORMULATION BURNS EXTREMELY CLEAN WITH A FRESHER SCENT
- PREVENTS PISTON SCUFFING, VARNISH FORMATION AND DEPOSIT BUILDUP
- IMPROVED COLD-WEATHER STARTUP WITH PRIME LUBRICATION

4639-349: QUART
5639-469: GALLON
4639-347: 2.5 GALLONS



FORMULA 50 OIL

- RECOMMENDED FOR NON-ARCTIC POWER VALVE 2-CYCLE ENGINES
- PERFORMS WELL OVER A WIDE RANGE OF OPERATING CONDITIONS
- MINIMIZES ENGINE WEAR
- PREVENTS RUST/DEPOSIT FORMATION

5639-475: QUART
5639-476: GALLON
5639-477: 2.5 GALLONS

SYNTHETIC 0W-40 OIL

- PROVIDES SUPERIOR PERFORMANCE IN ALL OPERATING CONDITIONS
- SYNTHETIC BASE STOCKS OFFER HIGH LUBRICITY THAT PROTECTS ENGINE FROM WEAR AND SCUFFING
- PREMIUM ADDITIVE PACKAGE HELPS PREVENT DEPOSIT FORMATIONS, RING STICKING AND PLUG FOULING WHILE PROVIDING OXIDATION STABILITY
- FOR USE IN ALL ARCTIC CAT 4-CYCLE SNOWMOBILES

5639-172: QUART
5639-173: GALLON

SYNTHETIC OIL CHANGE KIT

- INCLUDES GALLON OF SYNTHETIC 0W-40 OIL, FILTER, BELLY PAN PLUGS, WASHER AND DISPOSABLE FUNNEL

5639-174: '07-'11 1100 Z1 (INCLUDING TURBO)



ARCTIC CAT FORMULA SS SEMI-SYNTHETIC OIL

Our FORMULA SS SEMI-SYNTHETIC OIL OFFERS YOU THE BENEFITS OF A SEMI-SYNTHETIC FORMULATION AT A PHENOMENAL VALUE.

- USE IN ALL ARCTIC CAT 2-CYCLE ENGINES, INCLUDING ARCTIC POWER VALVE ENGINES
- SMOKELESS FORMULATION BURNS CLEAN
- PROVIDES POWER VALVE CLEANLINESS
- PROTECTS YOUR ENGINE AGAINST WEAR, SCUFFING AND VARNISH FORMATION

5639-470: QUART
5639-471: GALLON
5639-472: 2.5 GALLONS



Visit arcticcatlubricants.com for more information



SYNTHETIC TRANSMISSION LUBE

- DESIGNED FOR ARCTIC CAT CHAIN-DRIVEN SNOWMOBILES WITH REVERSE
- SYNTHETIC FORMULATION HELPS PROTECT AGAINST WEAR AT EXTREME TEMPERATURES
- INHIBITS RUST AND CORROSION DURING PERIODS OF NON-USE OR EXTENDED STORAGE

5639-039: 12 OZ.

ARCTIC CAT TRANSMISSION LUBE

- MAXIMIZES PERFORMANCE AND REDUCES FRICTION
- COATS SPROCKETS AND CHAIN ROLLERS
- PREVENT RUST, WEAR AND CORROSION
- EXTENDS CHAINCASE COMPONENT LIFE
- PROTECTS DURING PERIODS OF NON-USE

4639-364: 12 OZ.
1639-247: 2.5 GALLONS



SYNTHETIC CHAIN LUBE

- EXTENDS MACHINE LIFE BY MINIMIZING CHAIN STRETCH, SPROCKET AND GEAR WEAR

5639-038: 8 OZ.



CHAIN LUBE

- PERFECTLY LUBRICATES CHAIN AND SPROCKETS
- PREVENTS CORROSION
- EASY-POUR BOTTLE

4639-363: 8 OZ.



ACT FLUSH FLUID

- ALWAYS USE WHILE FLUSHING ACT GEARCASE FLUID

4639-333: 6 OZ.



SYNTHETIC ACT GEARCASE FLUID

- SPECIALLY FORMULATED FOR THE ACT™ DRIVE SYSTEM
- LOW SHEAR FORMULATION OFFERS EXCEPTIONAL LUBRICATION AT LOW TEMPS
- PROTECTS AGAINST WEAR AND CORROSION IN ACT DRIVE SYSTEMS WITH REVERSE

4639-361: 3 OZ. (NON-REVERSE)
4639-628: 12 OZ. (REVERSE)
5639-219: 15 OZ. (ACT ACER REVERSE)



SYNTHETIC SHOCK OILS

- SUPERIOR PERFORMANCE UNDER EXTREME RACING CONDITIONS
- INHIBITS FADING, REDUCES WEAR AND PROTECTS AGAINST CORROSION

4639-367: LIGHTWEIGHT - QUART
4639-369: MEDIUM/LIGHTWEIGHT - QUART
4639-368: MEDIUM WEIGHT - QUART



ARCTIC CAT SHOCK OIL

- LEND CONSISTENT PERFORMANCE TO FLOATING PISTON GAS SHOCKS
- IMPROVES RIDE QUALITY UNDER DEMANDING CONDITIONS

4639-366: QUART



SEMI-SYNTHETIC SHOCK OIL

- ENGINEERED WITH A HIGH VISCOSITY INDEX (VI) FORMULATION
- PROVIDES SUPERIOR, CONSISTENT PERFORMANCE IN SEVERE OPERATING AND RACING CONDITIONS
- PROTECTS AGAINST WEAR, FOAMING, OXIDATION AND CORROSION

5639-530: QUART



ARCTIC CAT ANTIFREEZE

- PROTECTS AGAINST FREEZING TO -34°F
- PROVIDES MAXIMUM COOLING BY RAISING BOILING POINT TO 265°F
- PREMIXED AND READY TO POUR
- ADDED BITTERING AGENT KEEPS PETS SAFE

0436-909: GALLON



FUEL-INJECTOR & CARBURETOR CLEANER

- PROVIDES PEAK PERFORMANCE
- CLEANS DEBRIS FROM VITAL FUEL SYSTEM/INJECTORS
- GREATLY HELPS AVOID REPAIRS

0436-904: 12 OZ.



ENGINE PRESERVER

- PROTECTS INTERNAL ENGINE PARTS DURING STORAGE
- AIDS IN CORROSION PREVENTION

0436-888: 12 OZ.



CAT CLEANER

- REMOVES OIL, GREASE AND GRIME FROM VINYL, METAL AND PAINT
- SPRAYS ON AND WIPES OFF QUICKLY
- WON'T ALTER FINISHES

4639-371: 22 OZ.



CLEANING KIT

- KEEPS SLED LOOKING BRAND-NEW
- INCLUDES 4 OZ. BOTTLES OF:
 - ALUMINUM CLEANER
 - WINDSHIELD CLEANER/DEFOGGER
 - SHOWROOM SHINE
 - BELLY PAN CLEANER/DEGREASER

4639-548



FUEL DE-ICER

- PREVENTS SYSTEM FAILURE AT THE COLDEST OF TEMPS
- SAFE ON INTERNAL PARTS
- WATER-ABSORBING ISOPROPYL BLEND

0436-906: 12 OZ.



FUEL STABILIZER

- PREVENTS FUEL BREAKDOWN, JET CLOGGING AND CORROSION
- SUGGESTED FOR USE IN STORED SLEDS

0436-907: 8 OZ.

ARCTIC CAT ALL-TEMP GREASE

- INCREASES COLD-TEMP BEARING, GEAR AND PIVOT POINT PERFORMANCE
- QUALITY LITHIUM 12-HYDROXY STEARATE FORMULA

4639-365: 14.5 OZ. TUBE



HI-TEMP BRAKE FLUID

- COMBINES LOW VISCOSITY AND LOW COMPRESSIBILITY FOR FIRM, QUICK RESPONSE

0436-908: 12 OZ.



WINDSHIELD CLEANER/DEFOGGER

- LEND MAXIMUM VISIBILITY
- WORKS EQUALLY WELL ON GOGGLES
- CONTAINS A DEFOGGING AGENT

4639-558: 4 OZ.

SEE YOUR DEALER FOR SPECIFIC APPLICATIONS AND PRICING

SEE YOUR DEALER FOR SPECIFIC APPLICATIONS AND PRICING



SLED LIFT

- SAFELY RAISES UP TO 625 LBS.
- 24-IN. CLEARANCE FOR LESS-FATIGUING SERVICE WORK
- CONVENIENTLY SLIPS UNDER SLED
- SHOWN WITH OPTIONAL WHEEL KIT

4639-992: \$379.95



FRONT END LIFT

- LIFTS FRONT END OF SLED OFF THE GROUND
- ALLOWS EASY SERVICING OF SKIS AND FRONT SUSPENSION

5639-151: \$119.95



CAT CADDY

- SUPERIOR MOBILITY FROM 2½-IN. SWIVEL CASTERS
- POWDER-COAT FINISH WITH LASER-CUT CAT LOGOS
- INCLUDES TWO SKI DOLLIES AND A TRACK DOLLY

4639-766: ALUMINUM - BLACK \$89.95

SLED LIFT WHEEL KIT

- OPTIONAL, LOCKABLE KIT FOR SAFE, EASY MOVEMENT

4639-993: \$109.95



JACK STAND

- IDEAL FOR SERVICE WORK OR WARMING UP ENGINES
- 33 IN. HIGH

4639-768: \$79.95



SHOP DOLLY



(ADDED FREIGHT CHARGES MAY APPLY)

- EXTRA-LONG HANDLE OFFERS SAFE MOBILITY OF ALL SLEDS INCLUDING 2-UP MODELS
- LARGE, HEAVY-DUTY WHEELS WITH SOLID RUBBER TIRES
- SECURE, ADJUSTABLE REAR BUMPER HOOK STRAP

5639-373: \$399.95



HANDLEBAR STAND

- SUPPORTS MACHINE ON ITS SIDE FOR EASY MAINTENANCE
- PREVENTS MACHINE DAMAGE
- ADJUSTABLE HEIGHT

5639-152: \$89.95



5639-579



5639-577

SLED SLIDES

- DURABLE, INJECTION-MOLDED PLASTIC (5639-577 & 5639-578) OR HEAVY-DUTY, POWDER-COATED STEEL (5639-579)
- INCLUDES TWO SKI SLIDES AND ONE TRACK SLIDE

5639-577: PLASTIC - BLACK
5639-578: PLASTIC - GREEN
5639-579: STEEL - GREEN

\$59.95



STANDARD TIE-DOWNS

- SECURES SLED TO TRAILER WITH HEAVYWEIGHT NYLON STRAPS
- 1 IN. X 69 IN., 1,000 LB. RATING; SOLD IN PAIRS

5639-411: BLACK
5639-415: GREEN

\$19.95

DELUXE TIE-DOWNS

- PROTECTS AGAINST SCRATCHING WITH INTEGRATED SOFT END LOOP
- HEAVY-DUTY NYLON STRAPS WITH DUAL S-HOOK RETAINER CLIPS
- 1.125 IN. X 78 IN., 1,200 LB. RATING; SOLD IN PAIRS

5639-423: \$34.95



DELUXE RATCHET-STYLE TIE-DOWNS

- SPRING-LOADED RETAINER CLIPS PREVENT S-HOOKS FROM FALLING OFF
- COMFORTABLE RATCHET-HANDLE GRIP
- LARGE GRAB HANDLE FOR EASY LENGTH ADJUSTMENT
- 1.125 IN. X 102 IN., 1,200 LB. RATING; SOLD IN PAIRS

5639-424: \$44.95



PULL STRAP

- HANDY STRAP HELPS TO FREE A STUCK SLED
- COMPACT SIZE ROLLS UP FOR EASY STORAGE

5639-512: \$16.95

TOW STRAP

- SAFE, EASY TOWING WITH EVEN WEIGHT DISTRIBUTION
- DURABLE NYLON STRAP
- HANDY STORAGE POUCH INCLUDED

4639-247: \$29.95



TOW ROPE

- EASY-ATTACH SPRING-CLIP BUCKLES
- HEAVY-DUTY NYLON ROPE

0636-577: \$13.95

HEATED SHIELD ADAPTER

- QUICKLY ADAPTS A HEATED SHIELD CORD TO THE SLED'S ACCESSORY OUTLET

5639-374: \$19.95



RACING TAPE

- EXTRA STRONG FOR ANY APPLICATION
- 2-IN. X 60-YD. ROLL

4639-579: BLACK
4639-580: GREEN
5639-103: ORANGE

\$16.95



TOUCH-UP PAINT

- RETAIN A SHOWROOM FINISH WHILE FILLING IN SCRATCHES AND CHIPS
- AVAILABLE IN COLORS TO MATCH MOST '05-'11 MODELS

1/2 OZ.
12 OZ. AEROSOL

SEE YOUR DEALER FOR SPECIFIC PART NUMBERS, APPLICATIONS AND PRICING



CTEK® BATTERY MAINTAINER

- THE IDEAL MAINTENANCE CHARGER FOR 12-VOLT BATTERIES
- FULLY AUTOMATIC FOR CHARGING AND MAINTENANCE
- TAKES ITS OWN READINGS AND BEGINS TO CHARGE
- ONCE FINISHED CHARGING, IT WILL SWITCH TO A MAINTENANCE PHASE
- FEATURES A PATENTED METHOD FOR RECONDITIONING SULFATED BATTERIES
- SPARK FREE, MAKING CONNECTION SAFER AND EASIER
- 12V, 800MA

5639-418: \$49.95

CTEK BATTERY CHARGER

- A GREAT ALL-ROUND CHARGER THAT EVERY HOUSEHOLD SHOULD HAVE
- FEATURES THREE MODES:
 - LOW-CURRENT MODE FOR SMALLER 12V BATTERIES USED IN SNOWMOBILES AND ATVs
 - HIGHER-CURRENT MODE FOR AUTOMOTIVE OR MARINE APPLICATIONS
 - WINTER MODE AIMED AT CHARGING AND MAINTENANCE IN COLD WEATHER
- FULLY AUTOMATIC FOR CHARGING AND MAINTENANCE
- TAKES ITS OWN READINGS AND BEGINS TO CHARGE
- ONCE FINISHED CHARGING, IT WILL SWITCH TO A MAINTENANCE PHASE
- FEATURES A PATENTED METHOD FOR RECONDITIONING SULFATED BATTERIES
- SPARK FREE, MAKING CONNECTION SAFER AND EASIER
- 12V, 3.3A

5639-419: \$69.95



ADDITIONAL BATTERY LEADS

- COMFORT INDICATOR FEATURES A THREE-LED BATTERY CONDITION INDICATOR

5639-421: ALLIGATOR CLIPS \$9.95
5639-484: STYLE 21 ADAPTER \$5.95
5639-397: COMFORT INDICATOR — STYLE 21 \$9.95
5639-420: RING TERMINALS \$5.95
5639-422: OUTLET \$9.95
5639-485: COMFORT INDICATOR — RING TERMINALS \$9.95



5639-421



5639-484



5639-397



5639-420



5639-422



5639-485

YUASA® BATTERY MAINTAINER

- AUTOMATIC CHARGER IS THE INDUSTRY'S MOST POWERFUL PLUG-IN WALL CHARGER
- INCLUDES QUICK-ATTACH ALLIGATOR CLIPS
- ALSO COMES WITH PERMANENT FUSED-RINGS FOR EVEN FASTER BATTERY MAINTENANCE
- 12V, 900MA

4639-998: \$34.95





BELTS

- CUSTOM FIT TO MATCH EACH ARCTIC CAT SLED AND SPECIFIC USE
- BETTER CONTACT WITH CLUTCH SURFACE AND FASTER ACCELERATION FROM DOUBLE COGS
- INCREASED BELT LIFE BY RUNNING 15° COOLER THAN AFTERMARKET BELTS
- REINFORCED WITH ARAMAX® ARAMID FIBERS FOR HUGE STRENGTH AND DURABILITY
- INCREASED POWER TRANSMISSION AND LESS SLIP FROM ARAMID-FIBER RUBBER COMPOUNDS

KEVLAR® DRIVE BELTS AVAILABLE FOR M, CROSSFIRE, F SERIES™ AND ZI™ MODELS, WHICH:

- DRAMATICALLY EXTEND BELT LIFE
- SUSTAIN BELT LENGTH BETTER THAN STEEL CORDS
- NOTE: PROPER BREAK-IN PERIOD REQUIRED

PREMIUM ARCTIC CAT “EXTENDED-LIFE” ORIGINAL EQUIPMENT REPLACEMENT BELTS

DON’T SETTLE FOR ANYTHING LESS THAN A DRIVE BELT BUILT SPECIFICALLY FOR YOUR SLED. PROVEN THROUGH EXTENSIVE LAB AND FIELD TESTING, ORIGINAL EQUIPMENT ARCTIC CAT REPLACEMENT BELTS ARE PRECISION-ENGINEERED FOR EACH ARCTIC CAT SNOWMOBILE.

CUSTOM-ENGINEERED FIT

WHILE NON-OEM AFTERMARKET BELTS OFFER “ONE CONSTRUCTION FITS ALL,” ARCTIC CAT RESEARCH & DEVELOPMENT “CUSTOM-ENGINEERS” EACH GENUINE ARCTIC CAT BELT TO MATCH THE SPECIFIC PERFORMANCE CHARACTERISTICS OF YOUR SLED. THIS PRODUCES THE BEST COMBINATION OF STRENGTH, DURABILITY AND RESPONSIVENESS FOR LOWER-HORSEPOWER, FAN-COOLED SLEDS ALL THE WAY UP TO HIGH-HORSEPOWER MUSCLESLEDS. EACH ONE IS BUILT USING ONLY THE FINEST MATERIALS, INCORPORATING PRECISION MANUFACTURING TECHNIQUES TO MEET EXACTING TOLERANCES.

TOP & BOTTOM COGS

ARCTIC CAT ORIGINAL EQUIPMENT BELTS ARE DOUBLE COGGED, SO MORE OF THE BELT CONTACTS THE CLUTCH SURFACES. THIS RESULTS IN FASTER ACCELERATION, MAXIMUM EFFICIENCY, AND SUPERB OVERALL PERFORMANCE. DOUBLE-COG DESIGN PROVIDES A LARGER SURFACE AREA FOR GREATER COOLING AND LONGER LIFE. IN FACT, THIS BELT RUNS UP TO 15° COOLER THAN FLAT-TOP AFTERMARKET BELTS.

ARAMAX HIGH-MODULUS (LOW-STRETCH) ARAMID-FIBER TENSILE MEMBER

THE ARAMAX INNER CORD PROVIDES INCREDIBLE STRENGTH AND DURABILITY FOR HIGH-HORSEPOWER, HIGH-PERFORMANCE SLEDS. IN ADDITION, EACH BELT IS REINFORCED WITH TOP-GRADE, HIGH-FLEXIBILITY, SHOCK-RESISTANT ARAMAX ARAMID-FIBER CORDS, AND CHEMICALLY TREATED FOR MAXIMUM POWER TRANSMISSION AND LENGTH STABILITY.

HIGH-PERFORMANCE PREMIUM COMPOUNDS

ARCTIC CAT’S OEM BELTS INCORPORATE ADVANCED “PREMIUM” COMPOUND MATERIALS THAT ENSURE OPTIMUM BELT PERFORMANCE UNDER ALL RIDING CONDITIONS. THE ADVANCED ARAMID-FIBER-LOADED RUBBER COMPOUND RESISTS WEAR AND DELIVERS CONSISTENT POWER WHILE MINIMIZING SLIPPAGE OVER A BROAD RANGE OF OPERATING TEMPERATURES. THE THICKER, HIGHLY FLEXIBLE DESIGN INCREASES GRIP TO CLUTCH SURFACES FOR INCREASED POWER TRANSMISSION.

ARCTIC CAT KEVLAR DRIVE BELTS

THESE ULTIMATE-PERFORMANCE ARCTIC CAT KEVLAR DRIVE BELTS ARE CUSTOM-ENGINEERED FOR M, CROSSFIRE, F SERIES AND ZI MODELS. EXTENDED-LIFE BELTS FEATURE TOP AND BOTTOM MOLDED COG CONSTRUCTION AND HIGH-PERFORMANCE COMPOUNDS. INSIDE, THE KEVLAR CORD PROVIDES INCREASED BELT LIFE AND SUSTAINS BELT LENGTH BETTER THAN STEEL CORDS. PLEASE NOTE THAT PROPER BELT “BREAK-IN” IS REQUIRED.

SEE YOUR DEALER FOR SPECIFIC PART NUMBERS, APPLICATIONS AND PRICING

A legion of more than 12,000 strong and growing daily, the Cat’s Pride Club™ is a crazed faction of ultra-obsessed Cat riders and we’re pretty sure you’re feeling the call. Join the elite and you’ll receive a Cat’s Pride™ Kit – designed with you in mind.

Annual memberships* are just \$40 for a single, \$70 for the entire family. For more details on the club that trumps all clubs or to order online, visit catsprideclub.com or contact Kathy Johnson at kjohnson@arcticcatinc.com.



*MEMBERSHIP FEES SUBJECT TO CHANGE WITHOUT NOTICE

MEN’S OUTERWEAR SIZING CHART

| SIZE | CHEST | WAIST | INSEAM |
|------|-----------|-----------|--------|
| S | 36" - 38" | 28" - 30" | 31" |
| M | 40" - 42" | 32" - 34" | 31" |
| MT | 40" - 42" | 32" - 34" | 33" |
| L | 44" - 46" | 36" - 40" | 31" |
| LT | 44" - 46" | 36" - 40" | 33" |
| XL | 48" - 50" | 42" - 44" | 31" |
| XLT | 48" - 50" | 42" - 44" | 33" |
| 2XL | 52" - 54" | 46" - 48" | 31" |
| 2XLT | 52" - 54" | 46" - 48" | 33" |
| 3XL | 56" - 58" | 50" - 52" | 31" |
| 3XLT | 56" - 58" | 50" - 52" | 33" |
| 4XL | 60" - 62" | 54" - 56" | 31" |
| 5XL | 64" - 66" | 58" - 60" | 31" |

5' 11" AND TALLER, USE TALL SIZES

WOMEN’S OUTERWEAR SIZING CHART

| SIZE | CHEST | WAIST | HIPS | INSEAM |
|------|-----------|-----------|-----------|--------|
| XS | 26" - 30" | 19" - 23" | 30" - 34" | 31" |
| S | 30" - 34" | 23" - 26" | 34" - 37" | 31" |
| M | 34" - 37" | 26" - 30" | 37" - 40" | 31" |
| MT | 34" - 37" | 26" - 30" | 37" - 40" | 33" |
| L | 37" - 40" | 30" - 34" | 40" - 43" | 31" |
| LT | 37" - 40" | 30" - 34" | 40" - 43" | 33" |
| XL | 40" - 43" | 34" - 38" | 43" - 46" | 31" |
| XLT | 40" - 43" | 34" - 38" | 43" - 46" | 33" |
| 2XL | 43" - 46" | 38" - 41" | 46" - 49" | 31" |
| 3XL | 46" - 49" | 41" - 45" | 49" - 52" | 31" |
| 4XL | 49" - 52" | 45" - 49" | 52" - 55" | 31" |

5' 8" AND TALLER, USE TALL SIZES

ONE-PIECE SIZING CHART

| SIZE | HEIGHT | CHEST | WAIST | INSEAM |
|------|-----------|-----------|-----------|--------|
| 2 | 33" - 35" | 21" - 22" | 19" - 20" | 16" |
| 3 | 36" - 38" | 22" - 23" | 20" - 21" | 17" |
| 4 | 39" - 41" | 23" - 24" | 21" | 18" |
| 5 | 42" - 44" | 24" - 25" | 21" - 22" | 19" |
| 6 | 45" - 46" | 25" - 26" | 22" | 20" |
| 7 | 47" - 49" | 26" - 27" | 22" - 23" | 21" |

YOUTH OUTERWEAR SIZING CHART

| SIZE | HEIGHT | CHEST | WAIST | INSEAM |
|------|-----------|-----------|-----------|--------|
| 4 | 45" - 47" | 23" - 25" | 20" - 22" | 17" |
| 6 | 47" - 49" | 25" - 26" | 22" - 23" | 19" |
| 8 | 49" - 50" | 26" - 27" | 23" - 24" | 21" |
| 10 | 51" - 54" | 27" - 28" | 24" - 25" | 23" |
| 12 | 55" - 58" | 29" - 30" | 25" - 26" | 25" |
| 14 | 59" - 61" | 30" - 32" | 26" - 27" | 26" |
| 16 | 62" - 64" | 32" - 33" | 27" - 28" | 27" |

SIZING CHARTS SHOULD BE USED AS GENERAL GUIDES FOR DETERMINING APPROXIMATE SIZE. DIFFERENCES IN INDIVIDUAL BODY SHAPE, AS WELL AS THE TYPE OF CUT AND STYLE OF EACH GARMENT, SHOULD BE CONSIDERED TO ENSURE APPROPRIATE FIT. PLEASE VISIT YOUR LOCAL AUTHORIZED ARCTICWEAR DEALER TO TRY ON YOUR SELECTION.