

# 2013 SNOWMOBILE BLACK & WHITE

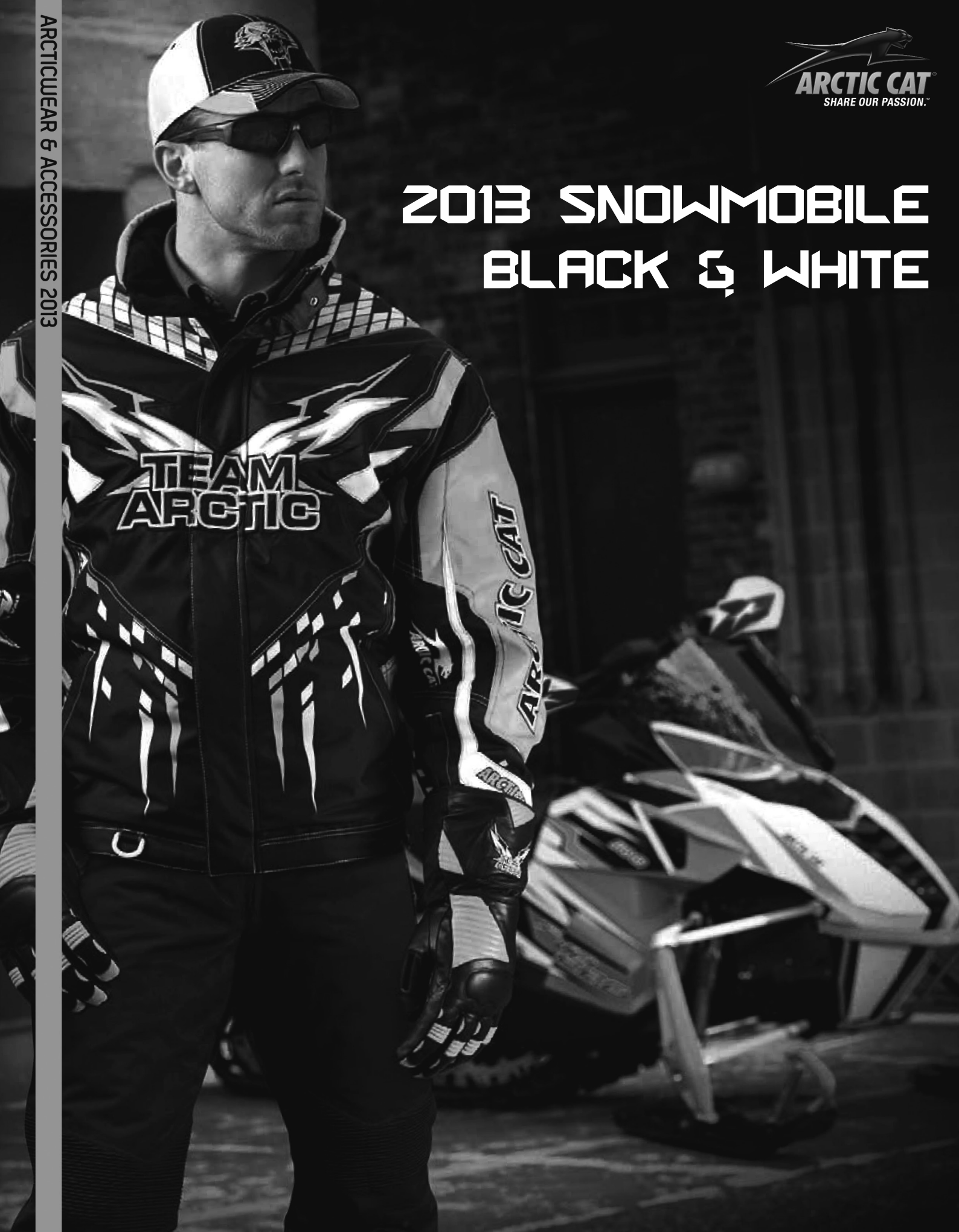

---

## Table of Contents

---

General POGA Information .....	1
Catalogs and Brochures.....	1
Using This Guide.....	1
Kit Instructions/Components.....	1
Track Exchange (New Vehicle Take-Off) .....	1
High Altitude Kit Exchange .....	1
Gear Exchange Program (New Vehicle Take-Off).....	1
Tunnel Replacement and Tunnel Stamping .....	1
ATV Frames.....	2
Warranty.....	2-3
Telephone Numbers.....	3
Ordering .....	3-5
Shipping .....	5
Equalized Freight.....	6-7
Ignition Keys.....	8
Sizing Charts.....	9
Arcticwear Size Ratios .....	10
Accessory Bag Dimensions .....	11
Kit Installation Times.....	12-13
Covers .....	14-15
Touring Bags.....	16-20
Touring Accessories .....	21-24
Windscreens .....	25-26
Custom Accessories.....	27-35
Mountain Accessories .....	36-41
Utility.....	42-46
Tracks.....	47-48
Wearbars.....	49-50
Traction & Control .....	51-55
General Maintenance.....	56-58
Oil & Care.....	59-63
Misc Accessories.....	64-69
120.....	69
Helmet and Neck Brace Parts.....	70-75
High Altitude Kits.....	76
2013 Optional Rear Suspension Springs.....	76-77
Drive Belt Application Guide .....	78
Drive Belt Dimension Chart.....	79
Promotional Products.....	80
Index.....	81

# Ignition Keys

■NOTE: The information listed below will help on ordering any replacement keys. On most models, the key identification number is stamped on the key. Record this number in the space provided in the Operator's Manual as well as on the sales receipt during each sale for reference if a consumer ever needs to replace or copy a key.

## ATV/ROV Keys

### 2006-Present ROV

### 2008-Present 400-1000 ATV (except 425)

0430-042	Left-Side Groove with key codes of 4000-4149
0430-043	Right-Side Groove with key codes of 4150-4299

■NOTE: A dealer can order blank keys and get them cut as long as they have the original key to copy. If the customer has lost both keys, the ignition switch assembly must be replaced.

■NOTE: If a dealer wants Arctic Cat to cut the key, the dealer needs to order a Key (p/n 0409-003). Dealer must then enter the 4-digit key code (4000-4299) found on each key.

### 1996-2007 ATV (except 2006-2007 250); 2011-Present 350, 366, & 425

0409-059 - A-Series	3409-011 - D-Series
0409-060 - B-Series	3409-012 - E-Series
3409-007 - C-Series	3409-013 - F-Series

■NOTE: A dealer can order blank keys and get them cut as long as they have the original key to copy. If the customer has lost both keys on a 2005 and later ATV, the ignition switch assembly must be replaced.

■NOTE: If a dealer wants Arctic Cat to cut the key for a model prior to 2005, the dealer needs to order a Key (ex: p/n 0409-059). Dealer must then enter code letter and 5 numbers (ex: E12345). Code can also be found on the ignition switch.

### 2006-Present 50, 90, 250, and 300

3304-520	Right-Side Cut
3304-521	Left-Side Cut

■NOTE: Hold the key pointing downward and the cut side is the narrow side. This will determine if the key is a right or left cut key.

■NOTE: A dealer can order blank keys and cut them as long as they have the original key to copy. If the customer has lost both keys, the ignition switch assembly must be replaced.

■NOTE: If a dealer wants Arctic Cat to cut the key, the dealer must order Key (p/n 0409-003). Dealer must specify the three digit code and specify if it is a left or right cut key.

## Snowmobile Keys

### 2010-Present 4-Stroke Snowmobile

0430-042	Left-Side Groove with key codes of 4000-4149
0430-043	Right-Side Groove with key codes of 4150-4299

■NOTE: A dealer can order blank keys and get them cut as long as they have the original key to copy. If the customer has lost both keys, the ignition switch assembly must be replaced.

■NOTE: If a dealer wants Arctic Cat to cut the key, the dealer needs to order a Key (p/n 0409-003). Dealer must then enter the 4-digit key code (4000-4299) found on each key.

### 1998-Present 2-Stroke Snowmobile 2010-Earlier 4-Stroke Snowmobile

■NOTE: If a dealer wants Arctic Cat to cut the key, the dealer needs to order a Key (p/n 0409-003). Dealer must then enter the code (ex: A79620).

■NOTE: Each key code is stamped and/or is molded into the head of the key (example: Electric start snowmobile keys with a "1A" code order p/n 0609-453). If a key has been lost, the code is also located on the front side of the ignition switch.

1998-Present 2-Stroke Models			
Electric Start Models		Non-Electric Start Models	
p/n	Key Series	p/n	Key Series
0609-453	1A	0609-349	1A
0609-454	1B	0609-350	1B
0609-455	1C	0609-351	1C
0609-456	1D	0609-352	1D
0609-457	1E	0609-353	1E
0609-458	1F	0609-354	1F
0609-459	2A	0609-355	2A
0609-460	2B	0609-356	2B
0609-461	2C	0609-357	2C
0609-462	2D	0609-358	2D
0609-463	2E	0609-359	2E
0609-464	2F	0609-360	2F

2-Stroke and 4-Stroke through 2006 (Closed Ignitions)	
p/n	Key Series
0609-412	A
0609-467	B
0609-468	C
0609-469	D
0609-470	E

2007-2009 4-Stroke Models	
p/n	Key Series
0409-059	A
0409-060	B

## Sizing Charts

### Adult Helmets\*

Helmet Size	Head-Hat Size	Head Circumference (in.)	Head Circumference (cm)
2XS	6 1/2-6 5/8	20 1/2-20 7/8	52-53
XS	6 3/4-6 7/8	21 1/4-21 5/8	54-55
Small	7-7 1/8	22-22 1/2	56-57
Medium	7 1/4-7 3/8	22 3/4-23 1/4	58-59
Large	7 1/2-7 5/8	23 5/8-24	60-61
XL	7 3/4-7 7/8	24 1/2-24 7/8	62-63
2XL	8-8 1/4	25 1/8-25 1/2	64-65
3XL	8 3/8-8 1/2	26-26 3/8	66-67
4XL	8 1/2-8 5/8	26 3/4-27 1/8	68-69

■NOTE: MX SnoCross helmets run about one size smaller on average than the regular shield helmets (i.e. MX SnoCross Large = Shield Helmet Medium).

### Youth Helmets

Helmet Size	Head-Hat Size	Head Circumference (in.)	Head Circumference (cm)
Medium	6 1/8 - 6 1/4	19 - 20	48 - 49
Large	6 3/8 - 6 1/2	20 - 21 1/2	50 - 51

■NOTE: This is a guideline only. Head shape can vary size.

■NOTE: Sizing charts should be used as general guides for determining approximate size. Differences in individual body shape, as well as the type of cut and style of each garment, should be considered to ensure appropriate fit. Please visit your local Authorized Arcticwear Dealer to try on your selection.

### Men's Outerwear

Size	Chest	Waist	Inseam
S	36" - 38"	28" - 30"	31"
M	40" - 42"	32" - 34"	31"
MT	40" - 42"	32" - 34"	34"
L	44" - 46"	36" - 40"	32"
LT	44" - 46"	36" - 40"	35"
XL	48" - 50"	42" - 44"	33"
XLT	48" - 50"	42" - 44"	36"
2XL	52" - 54"	46" - 48"	33"
2XLT	52" - 54"	46" - 48"	36"
3XL	56" - 58"	50" - 52"	33"
3XLT	56" - 58"	50" - 52"	36"
4XL	60" - 62"	54" - 56"	33"
5XL	64" - 66"	58" - 60"	33"

■NOTE: 5' 11" and taller, use tall sizes.

### Women's Outerwear

Size	Chest	Waist	Hips	Inseam
XS	26" - 30"	19" - 23"	30" - 34"	31"
S	30" - 34"	23" - 26"	34" - 37"	31"
M	34" - 37"	26" - 30"	37" - 40"	31"
MT	34" - 37"	26" - 30"	37" - 40"	33"
L	37" - 40"	30" - 34"	40" - 43"	31"
LT	37" - 40"	30" - 34"	40" - 43"	33"
XL	40" - 43"	34" - 38"	43" - 46"	31"
XLT	40" - 43"	34" - 38"	43" - 46"	33"
2XL	43" - 46"	38" - 41"	46" - 49"	31"
3XL	46" - 49"	41" - 45"	49" - 52"	31"
4XL	49" - 52"	45" - 49"	52" - 55"	31"

■NOTE: 5' 8" and taller, use tall sizes.

### Youth Outerwear

Size	Height	Chest	Waist	Inseam
4	45" - 47"	23" - 25"	20" - 22"	17"
6	47" - 49"	25" - 26"	22" - 23"	19"
8	49" - 50"	26" - 27"	23" - 24"	21"
10	51" - 54"	27" - 28"	24" - 25"	23"
12	55" - 58"	29" - 30"	25" - 26"	25"
14	59" - 61"	30" - 32"	26" - 27"	26"
16	62" - 64"	32" - 33"	27" - 28"	27"

### One-Piece

Size	Height	Chest	Waist	Inseam
2	33" - 35"	21" - 22"	19" - 20"	16"
3	36" - 38"	22" - 23"	20" - 21"	17"
4	39" - 41"	23" - 24"	21"	18"
5	42" - 44"	24" - 25"	21" - 22"	19"
6	45" - 46"	25" - 26"	22"	20"
7	47" - 49"	26" - 27"	22" - 23"	21"

### Glossary

**Missy/Womens** - Missy sizes, also referred to as straight sizes, are the sizes most commonly carried in standard women's clothing stores and generally run from 2 to 18 in even sizes.

**Juniors** - Juniors sizes are designed for young women ages 13 to 18 and are usually cut slimmer in the hips and bust than missy sizes. They're designated by uneven sizes 0 to 17.

# Arcticwear Size Ratios

Jackets and Pants												
	S	M	MT	L	LT	XL	XLT	2XL	2XLT	3XL		
Men's	2%	10%	2%	28%	6%	30%	8%	10%	2%	2%		
Women's	12%	33%	2%	32%	2%	16%	1%	2%				
	4	6	8	10	12	14	16					
Youth	4%	10%	18%	20%	20%	15%	13%					
	2	3	4	5	6	7						
Youth One Piece Suits	10%	14%	17%	22%	19%	18%						
Boots												
	6	7	8	9	10	11	12	13				
Men's		5%	8%	18%	25%	23%	15%	6%				
Women's	10%	23%	35%	22%	10%							
Youth Boots	8	9	10	11	12	13	1	2	3	4	5	6
Children's	7%	8%	11%	14%	15%	15%	15%	15%				
Boy's									18%	18%	26%	38%
Helmets												
	2XS	XS	S	M	L	XL	2XL	3XL				
TXi / PFP	2%	2%	11%	24%	30%	19%	9%	3%				
MX			4%	15%	41%	30%	10%					
Youth				42%	58%							
Gloves												
	XS	S	M	L	XL	2XL	3XL					
Adult	2%	6%	17%	32%	30%	11%	2%					
Youth		15%	30%	35%	20%							
Sportswear												
	S	M	L	XL	2XL							
Adult Shirts	5%	15%	35%	30%	15%							
	6-8	10-12	14-16									
Youth Shirts	27%	33%	40%									

## Accessory Bag Dimensions

Ref	p/n	Description		Length	Width/Depth	Height
97	6639-183	Tunnel Pack		15"	12"	4"
97	5639-573	Tunnel Pack		13"	13"	7"
97	5639-433	Tunnel Pack		24"	15"	6"
97	6639-048	Tunnel Gear Bag		22"	12"	7"
97	5639-574	Tunnel Gear Bag		20"	12"	8"
97	6639-049	Tunnel Cargo Bag	Main Side	20" 21"	12" 5"	5" 10"
98	6639-050	Saddlebags		18"	6"	10"
98	6639-046	Seat Pocket		7"	7"	3"
98	6639-047	Seat Pack		14"	14"	9"
98	5639-767	Goggle Holder		9"	6"	4"
98	5606-171	Touring Gear Bag		19"	13"	9"
98	4639-712	Touring Saddlebags		22"	7"	12"
99	5639-712	Windshield Bag		9"	14"	4"
99	6639-051	Windshield Bag		10"	25"	6"
99	4639-714	Windshield Bag		23"	10"	6"
99	5639-304	Windshield Bag		24"	12"	6"
99	4639-428	Windshield Bag		26"	3"	5"
99	6639-097	Hood Packs		8"	5"	5"
99	5639-708	Handlebar Bag		7"	10"	5"
99	5639-709	Handlebar Bag		7"	10"	8"
99	5639-434	Handlebar Bag		6"	7"	7"
99	5639-041	Custom Handlebar Bag		8"	4"	6"
119	5639-710	Mountain Pack		9"	14"	6"
119	5639-711	Mountain Gear Bag		18"	14"	8"
120	4639-732	Goggle Holder		10"	3"	6"
127	5639-049	Bearcat Gear Bag		31"	17"	15"
127	6606-252	Tunnel Pack		14"	17"	10"
17	3639-715	Windshield Bag		38"	5"	7"
17	3639-962	Windshield Bag		13"	3"	7"
18	6639-112	Crosstour Rack Bag		11"	15"	10"
18	4639-445	Saddlebags		20"	6"	11"
19	5639-301	Seat Pack	Main	9"	13"	8"
19	6639-200	Tank Bag		18"	7"	12"
19	4639-426	Tank Bag		13"	9"	10"
19	5639-305	Underhood Bag		9"	21"	9"
19	4639-427	Windshield Flair Bags		4"	11"	3"
19	3639-722	Firecat Trunk Bag		10"	14"	7"
36	3639-725	Mountain Pack		9"	12"	7"
36	5639-044	Mountain Gear Bag		14"	20"	9"
36	4639-727	Mountain Gear Bag	Main Side	17" 10"	16" 4"	8" 7"
36	5639-043	Mountain Seat Bag		12"	16"	9"



## Kit Installation Times

Ref	p/n	Description	Labor (min.)
21	5639-347, 348	Tunnel Rails	25
21	5639-717	2-Up Seat	30
21	5639-307	2-up Seat	20
21	5639-308	2-up Seat	15
21	5639-150	2-up Seat	20
21	4639-451	2-up Seat	60
21	5639-850, 851, 852, 6639-094	Sport Bumper	10
21	5639-825, 826, 827	Sport Bumper	20
21	5639-622, 623, 624	Sport Bumper	20
21	5639-065	Sport Bumper	15
21	5639-312	Touring Bumper	20
22	6639-053, 054, 055, 056	Pro Bumper	30
22	5639-718, 719, 720, 6639-158	ProCross Rack	15
22	6639-057, 058, 059, 060	Cargo Rack	5
22	5639-157	Crossfire Rack	15
22	5639-315	Sport Rack	10
23	5639-316, 317	Touring Rack	20
23	6639-181	Hitch Kit	40
23	6639-061	Hitch Kit	40
23	6639-182	Hitch Kit	40
23	6639-062	Hitch Kit	40
23	6639-098	Hitch Kit	15
23	6639-087	Hitch Kit	40
23	5639-724	Hitch Kit	40
23	5639-318	Hitch Kit	30
23	5639-319	Hitch Kit	30
23	5639-158	Hitch Kit	30
23	5639-159	Hitch Kit	30
23	5639-166	Hitch Kit	30
23	4639-723	Hitch Kit	25
23	4639-907	Hitch Kit	25
23	5639-202	Hitch Kit	30
23	4639-966	Hitch Kit	30
23	4639-452	Hitch Kit	20
23	2639-686	Hitch Kit	25
23	1639-607	Hitch Kit	30
23	1639-507	Hitch Kit	25
23	5639-725	Tow Hitch	15
23	5639-324	Tow Hitch	25
23	4639-124	Tow Hitch	25
23	1639-505	Tow Hitch	25
23	3639-189	Pintle Conversion	5
23	5639-859, 860	Tether Switch	40
23	4639-140	Tether Switch	30
23	4639-784	Tether Switch	30
23	5639-523	Tether Switch	40
23	4639-785	Tether Switch	40
23	0638-887	Tether Switch	40
24	4639-971	Heated Seat	45
24	5639-828, 829	Heated Seat	60
24	5639-858	DC Power	20
24	5639-258	DC Power	25
24	6639-157	Electric Start	180
24	5639-646	Electric Start	190
24	5639-198	Electric Start	190
24	4639-803	Electric Start	120
24	5639-321	Electric Start	190
24	4639-782	Electric Start	190
24	5639-531	Remote Start	60
24	5639-861	Engine Heater	45

Ref	p/n	Description	Labor (min.)
24	5639-823	Engine Heater	45
24	0638-188	Engine Heater	30
27	5639-729	Fox Float 2, Ski Shock	15
27	6639-088	Fox Float 2, Ski Shock	15
27	5639-730	Fox Float 2, Ski Shock	15
27	5639-583	Fox Float 2, Ski Shock	15
27	5639-584	Fox Float 2, Ski Shock	15
27	5639-585	Fox Float 2, Ski Shock	15
27	5639-731	Fox Float Evol, Ski Shock	15
27	6639-089	Fox Float Evol, Ski Shock	15
27	5639-732	Fox Float Evol, Ski Shock	15
27	5639-733	Fox Float R Evol, Ski Shock	15
27	6639-090	Fox Float R Evol, Ski Shock	15
27	5639-734	Fox Float R Evol, Ski Shock	15
27	5639-587	Fox Float R Evol, Ski Shock	15
27	5639-588	Fox Float R Evol, Ski Shock	15
27	5639-589	Fox Float R Evol, Ski Shock	15
27	5639-735	Fox Float X Evol, Ski Shock	15
27	5639-625	Fox Float X Evol, Ski Shock	15
27	5639-750	Fox Float 2, Rear Arm Shock	15
28	6639-063, 064, 065, 066,	Hood Graphics	30
28	5639-918, 919, 920, 921	Hood Graphics	30
28	6639-067, 068, 092, 093	Tunnel Graphics	20
28	5639-922, 923, 928, 929	Tunnel Graphics	20
28	6639-069, 070	Pink Accessory	40
28	5639-727, 728	Pink Accessory	40
28	5639-806	Pink Accessory	40
28	5639-838	Pink Accessory	60
33	5639-745, 746, 747, 748	Skid Plate, Front	10
33	6639-113, 114, 115, 116	Skid Plate, Rear	40
33	5639-893, 894, 895, 896	Skid Plate, Rear	40
33	4639-567	Skid Plate	30
33	3639-838, 839	Skid Plate	30
33	4639-564, 5639-582	Skid Plate	30
34	5639-898	Hood Flares	10
34	5639-809	Tunnel Flares	10
34	5639-892	Hood-Mounted Mirrors	30
35	5639-611	Toe Hold	20
37	5639-597, 598	Billet Rack	10
37	6639-159, 5639-773, 774, 775	ProClimb Rack.	15
37	4639-975, 976, 977	M Series Rack	10
37	5639-600, 601, 602	Mountain Seat	10
39	5639-897	Ice Scratchers	10
39	5639-580	Switch Guards	5
39	5639-945	Vertical Steering Post	90
40	5639-813	Telescopic Steering Post	70
40	5639-516	Telescopic Steering Post	40
40	5639-938, 939, 940	Narrow A-Arms	90
41	4639-995	Lightweight Front Axle	60
41	5639-528	Four Wheel Kit	25
41	4639-997	Two Wheel Kit	20
41	5639-107	Tunnel Flares	10
42	5639-389	Backup Light	35
42	5639-062	Cargo Rack	15
42	5639-060, 061	Side Rails	5
43	5639-803	Light Bar	20
43	5639-871	Strobe Light	20
43	5639-340	Receiver Winch	35
43	5639-456	Rear Harness	60
43	5639-457	Transport Mount	10

Ref	p/n	Description	Labor (min.)
44	5639-339	Receiver Bumper - Rear	30
44	5639-338	Receiver Bumper - Front	40
44	5639-386	Hitch	5
44	5639-387	Pivot Hitch Conversion	5
44	5639-254	Ski Skins	15
45	4639-970	Passenger Handwarmers	40
45	4639-802	Passenger Handwarmers	40
45	5639-341	Snow Plow Push Frame	25
45	0436-296	Snow Plow Blade	20
45	4639-967	Radiator, Under Seat	90
45	6639-180	Radiator, Front	60
45	6639-190	Gear Set, Low Ratio	50
55	6639-075, 118	Tunnel Protector	30
55	6639-178, 179	Tunnel Protector	30

■NOTE: The above information is intended for use as a guideline when quoting installation time for customers. Variables may cause installation time to be higher or lower. The times listed are not labor rates to be reimbursed to dealers.



## Covers



Page 94

### PREMIUM COVERS

Trailerable

Application	p/n
(A) '12-'13 F 800, F 1100 (Inc Turbo) - Green	6639-002
(A) '12-'13 F 800, F 1100 (Inc Turbo) - Orange	6639-003
(A) '12-'13 XF 800, XF 1100 (Inc Turbo) - Green	6639-004
(A) '12-'13 XF 800, XF 1100 (Inc Turbo) - Orange	6639-005
(A) '12-'13 M 800, M 1100, XF HC (Inc Turbo) - Green	6639-006
(A) '12-'13 M 800, M 1100, XF HC (Inc Turbo) - Orange	6639-007
(B) '12-'13 F5, F570; '07-'11 F Series; '09-'11 Z1, Z1 Turbo	6639-008
(B) '08-'13 T570, TZ1, TZ1 LXR Touring; '09-'13 Bearcat 570	6639-009
(C) '12-'13 F 800, F 1100 (Inc Turbo)	6639-010
(C) '12-'13 XF 800, XF 1100 (Inc Turbo)	6639-011
(C) '12-'13 M 800, M 1100, XF HC (Inc Turbo)	6639-012

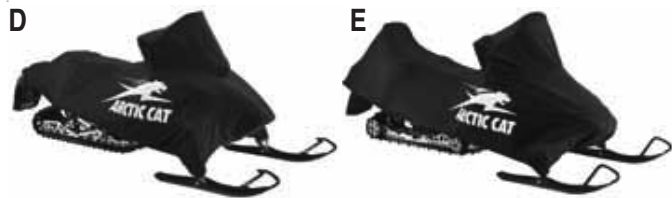

Page 95

### ARCTIC CAT CANVAS COVERS

Trailerable

Application	p/n
(D) '12-'13 F5, F570; '07-'11 F Series; '09-'11 Z1, Z1 Turbo	6639-013
(D) '12-'13 F 800, F 1100 (Inc Turbo)	6639-014
(D) '12-'13 XF 800, XF 1100 (Inc Turbo)	6639-016
(D) '12-'13 F 800, F 1100, XF 800, XF 1100 (Inc Turbo) w/2-Up Seat	6639-017
(D) '12-'13 M 800, M 1100, XF HC (Inc Turbo)	6639-018
(D) '00-'13 120	6639-021
(E) '08-'13 T570, TZ1, TZ1 LXR Touring; '09-'13 Bearcat 570	6639-019
(E) '09-'13 Bearcat 570 XT, Bearcat Z1 XT; '12-'13 Bearcat Z1 XT GS	6639-020

■NOTE: Bearcat Z1 XT GS model requires removal of light bar before installing cover.



Page 95

### TEAM ARCTIC CANVAS COVERS

Trailerable

Application	p/n
'12-'13 F 800, F 1100 (inc Turbo)	6639-042
'10-'13 Sno Pro 500	6639-043



Page 96

### CUSTOM COVERS (NON-CURRENT)

Trailerable

Application	p/n
<b>'03-'06 128"</b> Firecat, Sabercat	5639-017
<b>'99-'06 121"</b> Cougar, EXT, T660, Thundercat, Z, ZL, ZR, ZRT	5639-018
<b>'05-'08 M Series</b> M Series 153"-162"	5639-241
<b>'02-'04 Mountain</b> King Cat, Mountain Cat, Powder Special	5639-019
<b>'00-'06 2-Up Touring</b> Panther, Pantera, T660 Touring	5639-020
<b>'03-'08 Bearcat W/T</b> Bearcat W/T	5639-021
<b>'06-'11 Crossfire, CFR</b> '06-'11 Crossfire; '06-'07 M Series 141"	6639-044
'06-'11 CFR	6639-045
'06-'11 Crossfire w/2-Up Seat	5639-283
<b>'07-'13 F-Series w/2-Up Seat</b> '12-'13 F5, F570; '07-'11 F Series; '09-'11 Z1, Z1 Turbo	5639-286
<b>'10-'11 EXT</b> '10-'11 Z1 Turbo EXT; '11 F8 EXT	5639-547



Page 96

**DUST COVER**

Not Trailerable

**Application**

121-in.-128-in.  
136-in.-162-in. Mountain  
2-Up Touring

**p/n**

5639-705  
5639-706  
5639-716



Page 96

**UNDERCOVER LINER**

**Application**

Universal

**p/n**

5639-570

**LATE RELEASE  
AVAILABLE MID-SEASON**



**HALF COVER**

Not Trailerable

**Application**

'12-'13 F, M, XF

**p/n**

6639-202



**REPLACEMENT COVER STRAPS**

**Description**

(A) Sew-On Straps w/Buckles (Pkg 4)  
(B) Cinch Straps w/Hook (Pkg 4)

**p/n**

0636-610  
0636-527

## Touring Bags

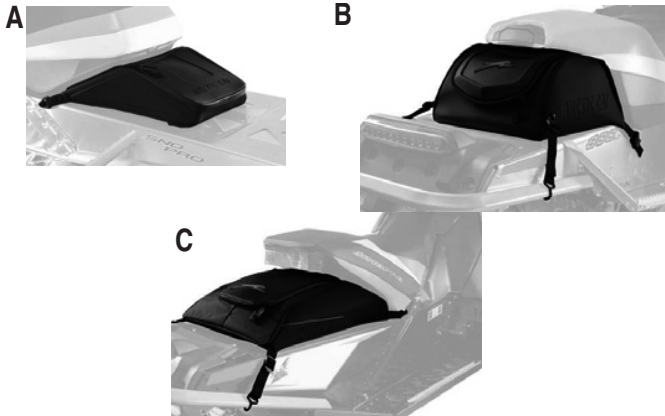

Page 97

### TUNNEL PACK

Application	p/n
(A) '12-'13 F 800, F 1100, F 1100 Turbo, M 800, M 800 HCR, M 1100, M 1100 Turbo, M 1100 Turbo HCR, XF 800, XF 800 HC, XF 1100, XF 1100 Turbo, XF 1100 Turbo HC	6639-183
(B) '12-'13 F5, F570; '07-'11 F Series, '10-'11 Z1, Z1 Turbo, Z1 Turbo EXT; '11 F8 EXT	5639-573
(C) '10-'13 Sno Pro 500, '10-'11 M Series	5639-433
<b>Replacement Hardware</b>	
Repl Spool w/Rivet, Pair (6639-183)	6639-154
Repl Front Clip, Pair (6639-183)	6639-155
Repl Strap w/Hook, Pk/4 (5639-433, 5639-573)	0641-994
Repl Cam Buckle, Pair (5639-573)	0639-089

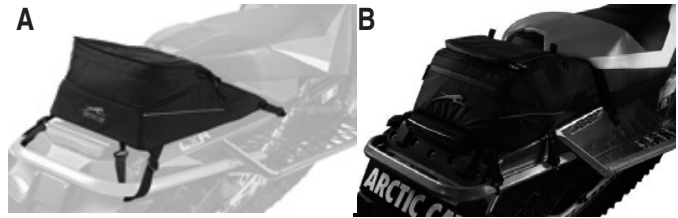

Page 97

### TUNNEL GEAR BAG

Application	p/n
(A) '12-'13 F 800, F 1100, F 1100 Turbo, XF 800, XF 1100, XF 1100 Turbo	6639-048
(B) '12-'13 F5, F570; '10-'11 F Series, M Series, Z1, Z1 Turbo, Z1 Turbo EXT; '11 F8 EXT	5639-574
<b>Replacement Hardware</b>	
Repl Spool w/Rivet, Pair (6639-048)	6639-154
Repl Front Clip, Pair (6639-048)	6639-155
Repl Ladder Lock, Pair (6639-048)	6639-156
Repl Strap w/Hook, Pk/4 (6639-048, 5639-574)	0641-994
Repl Cam Buckle, Pair (5639-574)	0639-089



Page 98

### SADDLEBAGS

Application	p/n
'12-'13 F 800, F 1100, F 1100 Turbo, XF 800, XF 1100, XF 1100 Turbo	6639-050
<b>Replacement Hardware</b>	
Repl Spool w/Rivet, Pair	6639-154
Repl Front Clip, Pair	6639-155



Page 97

### TUNNEL CARGO BAG

Application	p/n
'12-'13 F 800, F 1100, F 1100 Turbo, XF 800, XF 1100, XF 1100 Turbo	6639-049
<b>Replacement Hardware</b>	
Repl Spool w/Rivet, Pair	6639-154
Repl Front Clip, Pair	6639-155



Page 98

### SEAT POCKET

Application	p/n
'12-'13 F 800, M 800, XF 800 w/o Battery	6639-046



Page 98

## SEAT PACK

<b>Application</b>	<b>p/n</b>
'12-'13 F 800, F 1100, F 1100 Turbo, M 800, M 800 HCR, M 1100, M 1100 Turbo, M 1100 Turbo HCR, XF 800, XF 800 HC, XF 1100, XF 1100 Turbo, XF 1100 Turbo HC	6639-047
<b>Replacement Hardware</b>	
Repl Spool w/Rivet, Pair	6639-154
Repl Front Clip, Pair	6639-155
Repl Ladder Lock, Pair	6639-156
Repl Strap w/Hook, Pk/4	0641-994



Page 98

## GOGGLE HOLDER

<b>Application</b>	<b>p/n</b>
'12-'13 F 800, F 1100, F 1100 Turbo, M 800, M 800 HCR, M 1100, M 1100 Turbo, M 1100 Turbo HCR, XF 800, XF 800 HC, XF 1100, XF 1100 Turbo, XF 1100 Turbo HC	5639-767
<b>Replacement Hardware</b>	
Latch Repair Kit	6639-076



Page 98

## A. TOURING GEAR BAG

<b>Application</b>	<b>p/n</b>
'08-'13 T 570, TZ1 Touring; '09-'13 BC 570	5606-171

## B. TOURING SADDLEBAGS

<b>Application</b>	<b>p/n</b>
'08-'13 T 570, TZ1 Touring; '09-'13 BC 570	4639-712



Page 99

## WINDSHIELD BAG

Not recommended for fan-cooled machines.

<b>Application</b>	<b>p/n</b>
'12-'13 F 800, F 1100, F 1100 Turbo, M 800, M 800 HCR, M 1100, M 1100 Turbo, M 1100 Turbo HCR, XF 800, XF 800 HC, XF 1100, XF 1100 Turbo, XF 1100 Turbo HC	5639-712
'12-'13 F, M, XF With Accessory Mid & High Windshields (5639-799, 5639-800, 5639-801, 5639-916, 5639-917)	6639-051
'12-'13 F5, F570; '08-'13 T570, TZ1 Touring; '09-'13 BC; '09-'11 F Series, Z1	4639-714
'09-'13 TZ1 Turbo Touring; '09-'11 Z1 Turbo	5639-304
'05-'11 M Series; '06-'11 CF; '09-'11 CFR, M8 HCR	4639-428
'03-'06 FC; '04-'06 SC	3639-715
'00-'06 ZR; '01-'04 MC 600, 800, 900; '02-'05 PTA; '04-'06 KC; '03-'07 BC WT (Non-Turbo) Center Bag Only	3639-962



Page 99

## HOOD PACKS

<b>Application</b>	<b>p/n</b>
'12-'13 F 800, F 1100, F 1100 Turbo, M 800, M 800 HCR, M 1100, M 1100 Turbo, M 1100 Turbo HCR, XF 800, XF 800 HC, XF 1100, XF 1100 Turbo, XF 1100 Turbo HC	6639-097
<b>Replacement Hardware</b>	
Plastic Rivets (Pk/6)	5639-930

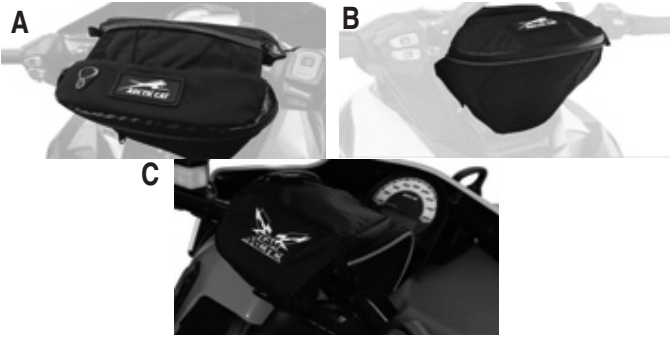

**Page 99**  
**HANDLEBAR BAG**

Application	p/n
(A) '12-'13 F 800, F 1100, F 1100 Turbo; '08-'13 T570, TZ1 Touring; '12-'13 F5, F570; '07-'11 F Series, Z1	5639-708
(B) '12-'13 M 800, M 800 HCR, M 1100, M 1100 Turbo, M 1100 Turbo HCR, XF 800, XF 800 HC, XF 1100, XF 1100 Turbo, XF 1100 Turbo HC; '09-'13 BC 570, BC XT; '05-'11 M Series; '06-'11 CF	5639-709
(C) 10-'13 Sno Pro 500	5639-434



**Page 99**  
**BAG HEATER KIT**

Application	p/n
Fits Handlebar Bags 5639-708, 5639-709	5639-837



**Page 99**  
**CUSTOM HANDLEBAR BAG**

Application	p/n
Universal	5639-041

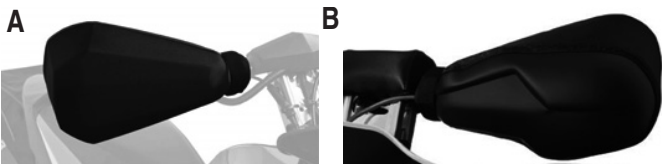

**Page 100**  
**SPORT MUFFS**

Application	p/n
(A) '12-'13 F 800, F 1100, F 1100 Turbo, M 800, M 800 HCR, M 1100, M 1100 Turbo, M 1100 Turbo HCR, XF 800, XF 800 HCR, XF 1100, XF 1100 Turbo, XF 1100 Turbo HC	5639-714
(B) '07-'11 Models	5639-524



**Page 101**  
**PASSENGER HAND MUFFS**

Application	p/n
'08-'13 T570, TZ1 Touring; '09-'13 BC 570, BC XT	5639-353



**Page 101**  
**HANDLEBAR MUFFS**

Application	p/n
Universal	5639-713

**LATE RELEASE**  
**AVAILABLE MID-SEASON**



**CROSSTOUR RACK BAG**

Application	p/n
'13 XF Crosstour	6639-112



**SADDLEBAGS**

Application	p/n
'07-'09 F Series; '09 Z1	4639-445
<b>Replacement Hardware</b> Repl Cam Buckle, Pair	1639-248



## SEAT PACK

**Application**

'12-'13 F5, F570; '07-'11 F Series, Z1, Z1 Turbo, Z1 Turbo EXT;  
'11 F8 EXT (Fixed or Adjustable Seat)

**p/n**

5639-301



## FIRECAT TRUNK BAG

**Application**

'03-'06 FC 128"

**Replacement Hardware**

Repl Cam Buckle, Pair

**p/n**

3639-722

1639-248



## TANK BAG

**Application**

(A) '12-'13 F, M, XF

(B) '12-'13 F5, F570; '07-'11 F Series; '08-'13 T 570, TZ1 Touring;  
'09-'13 BC 570; '09-'11 Z1, Z1 Turbo

**p/n**

6639-200

4639-426

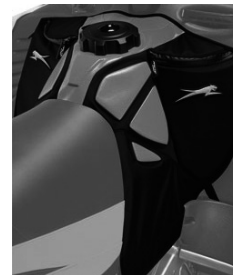

## TANK JACKET

**Application**

'05-'11 M Series; '09-'11 M8 HCR

'06-'11 CF; '09-'11 CFR

Replacement Velcro (Pair)

**p/n**

5639-053

5639-056

4639-602



## UNDERHOOD BAG

**Application**

'09-'13 TZ1 Touring; '09-'11 Z1 (Non-Turbo)

**p/n**

5639-305



## WINDSHIELD FLAIR BAGS

Sold as a pair.

**Application**

'00-'06 ZR; '01-'04 MC; '01-'07 Z; '02-'05 PTA;  
'04-'06 KC; '03-'08 BC 570, PA

**p/n**

4639-427



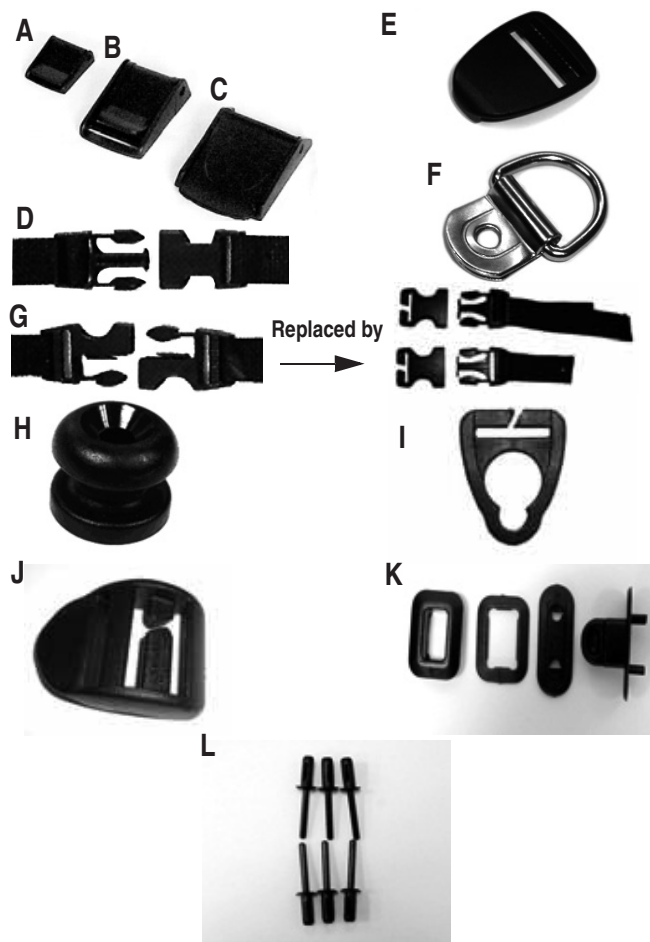

## REPLACEMENT HARDWARE

### Description

Description	p/n
(A) Cam Buckle (Pair) - 1"	0639-089
(B) Cam Buckle (Pair) - 1-1/2"	1639-248
(C) Cam Buckle (Pair) - 2"	2639-152
(D) SR1 Buckle Kit (Pair)	0638-082
(E) Strap Hook (Pair)	0641-485
(F) Tunnel Clip - Black (Each)	6606-244
(G) Buckle Kit - Unisex Replacement (Pair)	2639-662
(H) Spool (Pair)	6639-154
(I) Bag Clip (Pair)	6639-155
(J) Ladder Lock (Pair)	6639-156
(K) Latch Repair Kit (5639-767)	6639-076
(L) Plastic Rivets (6/pk)	5639-930



## FOAM BEVERAGE HOLDER

### Description

Description	p/n
Universal	1639-599



## Touring Accessories

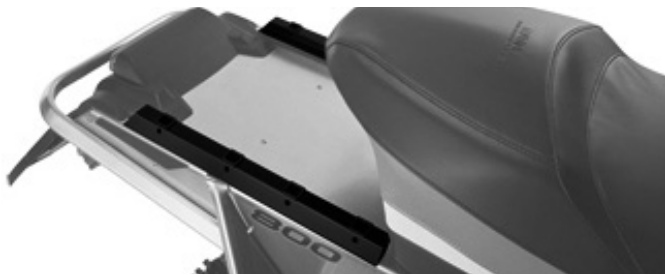

Page 101

### TUNNEL RAILS

Includes mounting pockets for 2-up seat and rack.

#### Application

'12-'13 F5, F570; '10-'11 F Series, Z1, Z1 Turbo  
'10-'11 Z1 Turbo EXT; '11 F8 EXT

#### p/n

5639-347  
5639-348



Page 102

### SPORT BUMPER - ALUMINUM

#### Application

(A) '12-'13 F 800, F 1100, M 800, M 800 HCR, M 1100, XF 800, XF 800 HC, XF 1100

#### Color

Black 5639-850  
Green 5639-851  
Orange 5639-852  
White 6639-094

p/n

(B) '12-'13 F5, F570; '08-'13 T570, TZ1 Touring; '09-'12 BC 570; '09-'11 Z1, Z1 Turbo; '07-'11 F Series

Black 5639-825  
Green 5639-826  
Orange 5639-827

(C) '05-'11 M SERIES; '06-'11 CF; '09-'11 CFR, M8 HCR

Black 5639-622  
Green 5639-623  
Orange 5639-624

(D) '10-'13 Sno Pro 500

Green 5639-065

(E) '12 Sno Pro 600

Black 5639-994



Page 101

### 2-UP SEAT KIT

■Note: The 2013 XF Crosstour has a standard hitch with the mounting pockets required for the 2-Up Seat

#### Application

(A) '12-'13 F 800, F 1100, F 1100 Turbo, XF 800, XF 1100, XF 1100 Turbo (Requires Hitch Kit) '13 XF Crosstour

#### p/n

5639-717

(B) '12-'13 F5, F570; '10-'11 F Series, '10-'11 Z1, Z1 Turbo, Z1 Turbo EXT; '11 F8 EXT (Requires Tunnel Rails)

5639-307

(C) '09-'11 CF, CFR (Requires Hitch Kit with mounting pockets) - will accept rear rack or rear bag

5639-308

(D) '09 F Series (Liquid-Cooled), Z1, Z1 Turbo

5639-150

(D) '07-'08 F Series (Liquid-Cooled), JR

4639-451



Page 102

### TOURING BUMPER - STEEL

■NOTE: Top tube interferes with hood removal on turbo models.

#### Application

'12-'13 F5, F570; '08-'13 T570, TZ1 Touring; '09-'13 BC 570; '09-'11 Z1 (Non-Turbo); '07-'11 F Series

#### Color

Black 5639-312

#### p/n



## PRO BUMPER

Application	Color	p/n
'12-'13 F 800, F 1100, F 1100 Turbo, M 800, M 800 HCR, M 1100, M 1100 Turbo, M 1100 Turbo HCR, XF 800, XF 800 HC, XF 1100, XF 1100 Turbo, XF 1100 Turbo HC	Unpainted	6639-053
	Black	6639-054
	Green	6639-055
	Orange	6639-056



Page 103

## CARGO RACK

Requires Hitch Kit with eight mounting pockets. 11" x 14" W

Application	Color	p/n
'12-'13 F 800, F 1100, F 1100 Turbo XF 800, XF 800 HC, XF 1100, XF 1100 Turbo, XF 1100 Turbo HC, M 153"	Black	6639-057
	Green	6639-058
	Orange	6639-059
	Silver	6639-060

Rack Bag (See page 18)

6639-112



Page 103

## PROXCROSS RACK

8" x 11½" W

Application	Color	p/n
'12 F 800, F 1100, F 1100 Turbo, XF 800, XF 1100, XF 1100 Turbo	Black	6639-158
	Green	5639-718
	Orange	5639-719
	Silver	5639-720

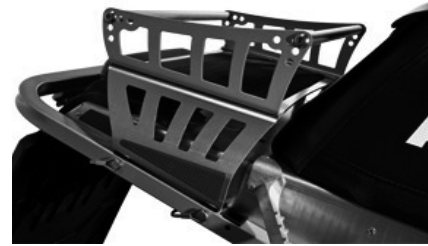

## CROSSFIRE RACK

Requires Hitch Kit with mounting pockets.

Application	Color	p/n
'09-'11 CF, CFR	Unpainted	5639-157

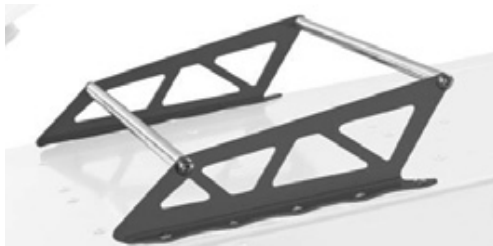

## PROCLIMB RACK

8" x 11½" W

Application	Color	p/n
'12-'13 M 800, M 800 HCR, M 1100, M 1100 Turbo, M 1100 Turbo HCR, XF 800 HC, XF 1100 Turbo HC; '13 F 800, F 1100, F 1100 Turbo, XF 800, XF 1100, XF 1100 Turbo	Black	6639-159
	Green	5639-773
	Orange	5639-774
	Silver	5639-775



## SPORT RACK

Mounts directly to the tunnel, or quick-attach to Tunnel Rails.

Application	Color	p/n
'12-'13 F5, F570; '10-'11 F Series, Z1, Z1 Turbo, Z1 Turbo EXT; '11 F8 EXT	Unpainted	5639-315

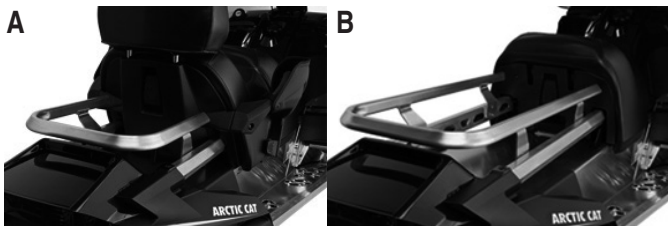

## TOURING RACK

### Application

'08-'13 T570, TZ1 Touring; '09-'13 BC 570

### Style p/n

(A) Short 5639-316  
(B) Long 5639-317

## Page 103

## PINTLE CONVERSION KIT

### Application

Fits Pivot-Style Hitch Kits

### p/n

3639-189



## Page 103

## HITCH KITS - PIVOT STYLE

Hitch Kits with eight mounting pockets will accept both a 2-Up Seat and a Cargo Rack

### Application

Application	p/n
'13 F 800, F 1100, F 1100 Turbo 129" (Inc 8 Mounting Pockets)	6639-181
'12 F 800, F 1100, F 1100 Turbo 128" (Inc 8 Mounting Pockets)	6639-061
'13 XF 800, XF 1100, XF 1100 Turbo 141" (Inc 8 Mounting Pockets)	6639-182
'12 XF 800, XF 1100, XF 1100 Turbo 141" (Inc 8 Mounting Pockets)	6639-062
'13 XF Crosstour (Hitch Components Only)	6639-098
'12-'13 M 800, M 800 HCR, M 1100, M 1100 Turbo, XF 800 HC, XF 1100 Turbo HC 153" (Inc 8 Mounting Pockets)	6639-087
'12-'13 M 800, M 1100 Turbo, M 1100 Turbo HCR 162"	5639-724
'12-'13 F5, F570; '10-'11 F Series, Z1, Z1 Turbo 128"	5639-318
'10-'11 Z1 Turbo EXT; '11 F8 EXT 144"	5639-319
'09-'11 M Series; '10 M8 HCR 153"	5639-158
'09-'11 M Series 162"; '11 M8 HCR 153"	5639-159
'09-'11 CF 141" (Inc 8 Mounting Pockets)	5639-166
'08-'13 T570, TZ1 Touring	4639-723
'09-'11 CFR 128" (Inc 8 Mounting Pockets)	5639-202
'09 F Series, Z1, Z1 Turbo 128"	4639-966
'07-'08 JR; '07-'08 F Series (Liquid-Cooled)	4639-452
'03-'06 FC; '04-'06 SC 128" & 144"	2639-686
'00-'05 PTA; '04-'07 T660 Touring	1639-607
'99-'02 PA; '99-'06 121" Models; '07 Z, T660 Trail	1639-507

## HITCH KIT PINTLE

### Application

'08-'13 T570, TZ1 Touring

### p/n

4639-907

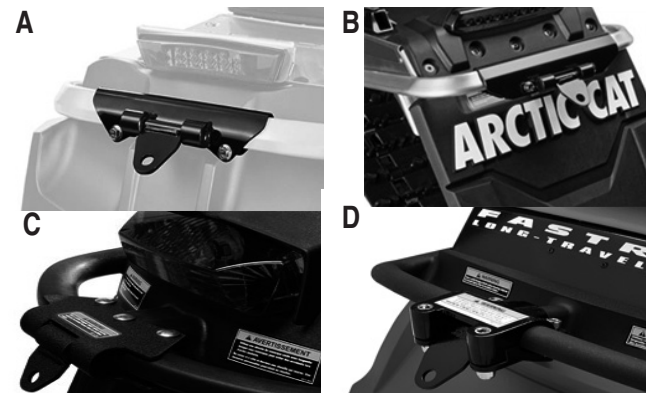

## Page 103

## TOW HITCH

Light duty use.

### Application

Application	p/n
(A) '12-'13 F 800, F 1100, F 1100 Turbo, M 800, M 800 HCR, M 1100, M 1100 Turbo, M 1100 Turbo HCR, XF 800, XF 800 HC, XF 1100, XF 1100 Turbo, XF 1100 Turbo HC	5639-725
(B) '12-'13 F5, F570; '09-'11 CF, CFR, M Series; '10-'11 F Series, Z1, Z1 Turbo, Z1 Turbo EXT; '11 F8 EXT	5639-324
(C) '05-'08 M Series; '06-'08 CF	4639-124
(D) '99-'06 121-in. Models; '07 Z, T660 Trail	1639-505



## Page 104

## TETHER SWITCH

### Application

Application	p/n
'12-'13 F 800, M 800, XF 800, XF 800 HC	5639-859
'12-'13 F 1100, F 1100 Turbo, M 1100, M 1100 Turbo, XF 1100, XF 1100 Turbo, XF 1100 Turbo HC	5639-860
'07-'11 F Series Std & Sno Pro; '08-'11 CF, M Series; '09-'11 CFR; '99-'07 Normally Open Circuits	4639-140
'07-'11 F LXR; '07-'12 T570	4639-784
'10-'11 Z1; '10-'13 TZ1, BC Z1 XT	5639-523
'08-'09 TZ1; '09 Z1, BC Z1 XT (Inc Turbo) Normally Closed Circuits	4639-785 0638-887

Replacement Tether Cord

0709-055



Page 104

## HEATED SEAT KIT

■NOTE: Not available for 2-stroke - power output insufficient.

Application	p/n
'12-'13 F 1100, F 1100 Turbo, XF 1100, XF 1100 Turbo	5639-828
'12-'13 M 1100, M 1100 Turbo	5639-829
'09-'13 BC Z1 XT (Driver & Passenger)	4639-971
'11-'13 BC Z1 XT LTD (Passenger Only)	5639-638



Page 104

## DC POWER KIT

Application	p/n
'12-'13 F 800, M 800, XF 800, XF 800 HC	5639-858
'09-'11 CF, CFR, M Series 800, 1000	5639-258



Page 104

## ELECTRIC START KIT

For replacement parts, see appropriate parts manual.

Application	p/n
'12-'13 F 800, M 800, XF 800	6639-157
'11 F Series 800	5639-646
'09-'10 F Series 800, 1000	5639-198
'08-'11 CF, M Series 500, 600	4639-803
'10 BC 570	5639-321
'08-'11 F Series 500, 600	4639-782

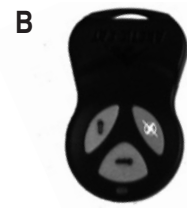

## REMOTE START KIT

Application	p/n
'08-'13 TZ1 Touring; '09-'13 BC Z1 XT, '09-'11 Z1, Z1 Turbo	5639-531

### Replacement Transmitter

Replacement Transmitter	p/n
All Production and Accessory Remote Start Kits (A) 2 Button	0630-146
(B) 3 Button	0630-187

Replacement Battery A23S 12V (purchase locally)

■ NOTE: For programming instructions, please visit [Cat Tracker Online](#).



Page 104

## ENGINE HEATER

Application	p/n
'12-'13 F 1100, F 1100 Turbo, M 1100, M 1100 Turbo, XF 1100, XF 1100 Turbo	5639-861
'07-'13 TZ1; '09-'13 BC Z1 XT, TZ1 Turbo; '07-'11 Z1, Z1 Turbo	5639-823
'99-'07 LC Models Except CF, F, FC, JR, M, SC, 4-Stroke	0638-188

## BATTERIES

Application	Year	p/n
BC 570	'09-'13	0745-047
	'04-'08	0745-059
BC 570 XT	'09-'13	0745-047
BC Z1 XT	'09-'13	0645-480
CF 500	'07-'09	0645-480
CF 600	'06-'11	0645-480
F5	'07-'13	0745-047
F570	'08-'13	0745-047
F6	'07-'11	0745-047
F8, F 1000	'07-'11	0645-480
F 800	'12-'13	0645-480
F 1100, F 1100 Turbo	'12-'13	0645-480
M 800	'12-'13	0645-480
M 1100, M 1100 Turbo	'12-'13	0645-480
M6	'05-'11	0645-480
T500	'08-'09	0745-047
T570	'08-'13	0745-047
TZ1 Touring	'08-'13	0645-480
TZ1 Turbo Touring	'09-'13	0645-480
XF 800	'12-'13	0645-480
XF 1100, XF 1100 Turbo	'12-'13	0645-480
Z1, Z1 Turbo	'09-'11	0645-480

# Windscreens

Page 105

	'12-'13 F 800, F 1100, M 800, M 1100, XF 800, XF 1100 (Inc Turbo)			'12-'13 F5, F570; '07-'11 F Series; '09-'11 Z1; '09-'13 Bearcat, TZ1			'05-'11 M Series; '06-'11 CF; '09-'11 CFR, M8 HCR		
	p/n	Height	Width	p/n	Height	Width	p/n	Height	Width
<b>Extreme Low</b>									
Black	5639-790	8"	15 1/2"				5639-525		
White	5639-791	8"	15 1/2"				5639-526		
<b>Flyscreens</b>									
Black	5639-794	11"	15 1/2"				5639-140	12"	25 1/2"
Green	5639-792	11"	15 1/2"				5639-138	12"	25 1/2"
Green/White	6639-194	11"	15 1/2"						
Orange	5639-793	11"	15 1/2"				5639-139	12"	25 1/2"
<b>Windscreens</b>									
Low, Black	5639-797	13"	20"	5639-130	7 1/2"	29"	5639-136	14 1/2"	27 3/4"
Low, Green	5639-795	13"	20"	5639-128	7 1/2"	29"	5639-134	14 1/2"	27 3/4"
Low, Orange	5639-796	13"	20"	5639-129	7 1/2"	29"	5639-135	14 1/2"	27 3/4"
Low, Pink	5639-798	13"	20"						

**Side Deflectors (Pair) 5639-785 Fits '12-'13 F, M, XF Accessory Flyscreens and Low Windscreens (Overall Width 25")**

<b>Windshields</b>									
Low, Tint				5606-960	8 1/2"	29"			
Mid, Tint	5639-799*	16"	30"	5639-439	12"	33"	4639-203	16"	29 3/4"
Mid, Clear, Green	5639-916*	16"	30"						
Mid, Clear, Orange	5639-917*	16"	30"						
Mid, Clear, Pink	5639-800*	16"	30"	5639-631	12"	33"			
High, Tint	5639-801*	19"	32"	4639-719	15 1/4"	33"	4639-227	18 1/2"	29 3/4"
Extreme High, Clear	6639-078*	21"	32"	5639-222**	20 1/2"	33"			
<b>Windshields</b>	<b>'12-'13 Models with Vertical Steering</b>								
Mid, Tint	6639-077								

\*Mid, High, and Extreme High Windshields are not recommended for '12-'13 models with Vertical Steering \*\*Requires Brace Kit (5639-628)

<b>Windshields</b>	'10-'13 Sno Pro 500; '08-'11 Sno Pro 600			'09-'13 TZ1 Turbo; '09-'11 Z1 Turbo			'04-'06 KC; '01-'04 MC 500-900; '02-'05 PTA; '01-'08 PA; '01-'07 Z; '01-'03 ZL; '00-'06 ZR		
Low, Black				5639-142***	10"	31"			
Low, Green							5639-221	12"	32"
Mid, Tint	5639-615	13"	32"	6606-274***	10"	31"	2606-471	14 1/2"	31 1/2"
High, Tint	5639-500	16"	32"	5639-154****	15"	31"	2606-163	16"	33"

\*\*\*Turbo Low/Mid Windshield requires Brace Kit (5639-518) \*\*\*\*Turbo High Windshield requires Brace Kit (5639-455)

<b>Windshields</b>	'03-'06 FC, SC			'99-'01 600 Touring, PTA; '99-'02 MC 1000; '99-'02 TC, ZRT			'98-'00 PS, Z, ZL; '98-'99 ZR		
Low, Green	5639-220	11 3/4"	32 3/4"						
Low, Tint							1606-818	12 1/4"	30 1/4"
Mid, Tint	3606-943	13 3/4"	31 3/4"	1606-323	14"	31"	1606-074	15 3/4"	28"
High, Tint				1606-541	17 1/2"	31"			

<b>Windshields</b>	'06-'08 BC WT Turbo; '04-'07 T660		
High, Tint	3639-906	20"	33"

<b>Production Windshields</b>	'12-'13 F, M, XF		
Sno Pro, Black	6606-376	8 1/2"	20"
Mountain, Black	6606-134	13 1/2"	25 1/2"
LXR, Tint	6606-377	16 1/2"	27 1/2"
SnoCross	6606-396	8 1/2"	20"
Cross Country, Black - Standard	6606-134	13 1/2"	25 1/2"
Cross Country, Tint - Optional	6606-513	16 1/2"	25 1/2"

■NOTE: If replacing the adjustable windshield on '07 F Series and JR, Windshield Mounting Kit (p/n 4639-735) is required.



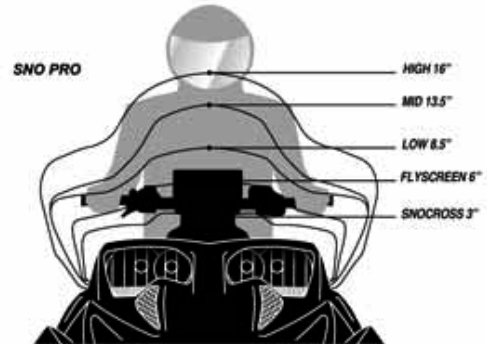
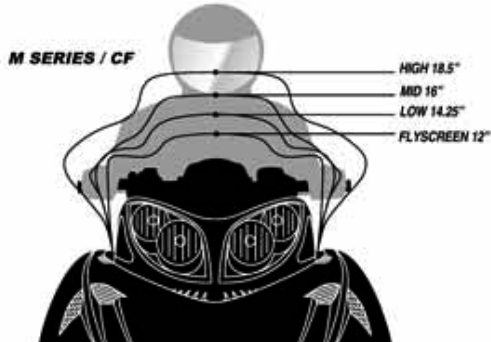
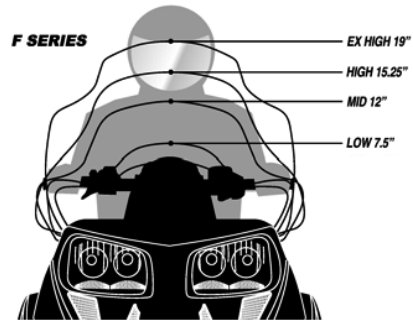
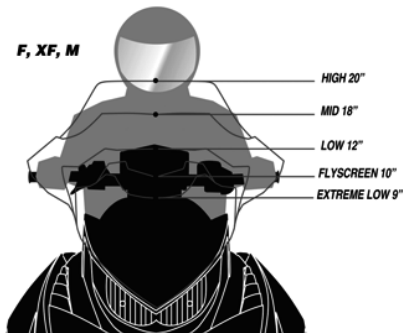

Measurements are taken vertically from dash panel to top of windscreen. Style illustrations apply to indicated models only. Use reference point to determine style of windscreen to order. Style of windscreen for all other models is determined by measuring upward from lowest front center point on windscreen to top center point. Accessory windshields do not have pre-drilled mirror mounting holes.



Page 107

### A. WINDSHIELD BRACE KIT

**Application**

Turbo Low/Mid Windshield (5639-142, 6606-274)  
 Turbo High Windshield (5639-154)  
 Extreme High Windshield (5639-222)

**p/n**

5639-518  
 5639-455  
 5639-628

### B. WINDSHIELD MOUNTING RING

**Description**

Universal (Each)

**p/n**

2606-853

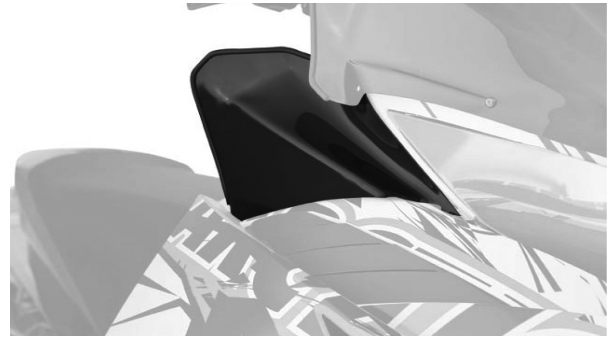

Page 106

### SIDE DEFLECTORS

**Application**

'12-'13 F, M, XF Accessory Flyscreens and Low Windscreens

**p/n**

5639-785

## Custom Accessories



Page 109

### A. FOX FLOAT 2

Sold in pairs. Includes 150 psi pump.

Application	p/n
'12-'13 F 800, F 1100, F 1100 Turbo, XF 800, XF 1100, XF 1100 Turbo (42" Ski Stance)	5639-729
'13 M 800, M 1100, M 1100 Turbo (38" Ski Stance)	6639-088
'12 M 800, M 1100, M 1100 Turbo (40" Ski Stance)	5639-730
'12-'13 F5, F570; '07-'11 F Series; '09-'11 Z1, Z1 Turbo, Z1 Turbo EXT	5639-583
'05-'11 M Series	5639-584
'06-'11 CF; '09-'11 CFR	5639-585

### B. FOX FLOAT EVOL

Sold in pairs. Includes 300 psi pump.

Application	p/n
'12-'13 F 800, F 1100, F 1100 Turbo, XF 800, XF 1100, XF 1100 Turbo (42" Ski Stance)	5639-731
'13 M 800, M 1100, M 1100 Turbo (38" Ski Stance)	6639-089
'12 M 800, M 1100, M 1100 Turbo (40" Ski Stance)	5639-732

### C. FOX FLOAT R EVOL

Sold in pairs. Includes 300 psi pump.

Application	p/n
'12-'13 F 800, F 1100, F 1100 Turbo, XF 800, XF 1100, XF 1100 Turbo, M 800 HCR (42" Ski Stance)	5639-733
'13 M 800, M 1100, M 1100 Turbo, M 1100 Turbo HCR (38" Ski Stance)	6639-090
'12 M 800, M 1100, M 1100 Turbo, M 1100 Turbo HCR (40" Ski Stance)	5639-734
'12-'13 F5, F570; '07-'11 F Series; '09-'11 Z1, Z1 Turbo, Z1 Turbo EXT	5639-587
'05-'11 M Series	5639-588
'06-'11 CF; '09-'11 CFR	5639-589

### D. FOX FLOAT X EVOL

Sold in pairs. Includes 300 psi pump.

Application	p/n
'12-'13 F 800, F 1100, F 1100 Turbo, XF 800, XF 1100, XF 1100 Turbo, M 800 HCR (42" Ski Stance) XC Valving	5639-735
'10-'13 Sno Pro 500 - XC Valving	5639-625



Page 109

### FOX FLOAT 2 REAR ARM

Application	p/n
'12-'13 M 800, M 1100, M 1100 Turbo, XF 800, XF 1100, XF 1100 Turbo; '08-'11 M Series	5639-750

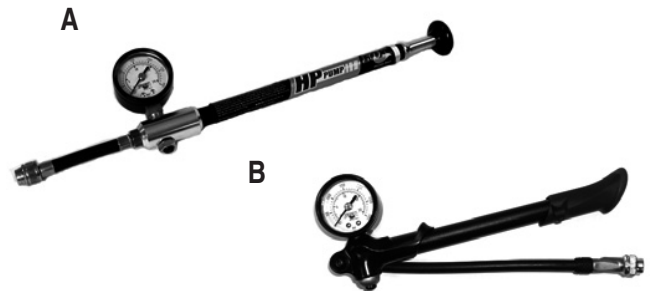

### AIRSHOX PUMP

Application	p/n
(A) Single Gauge 150 PSI (Float, Float 2)	2603-614
(B) Single Gauge 300 PSI (Float Evol, Float R Evol, Float X Evol)	0641-257

■Note: Fox has made a running change to pump 0641-257. It is now a single-gauge 300 psi pump. The previous version was a dual-gauge 100 psi, 300 psi.



Page 109

### AIRSHOX GUARDS

Description	Color	p/n
Fox Float 2, Float Evol, Float R Evol	Black	6639-080
	Green	6639-081
	Orange	6639-082
	White	6639-083



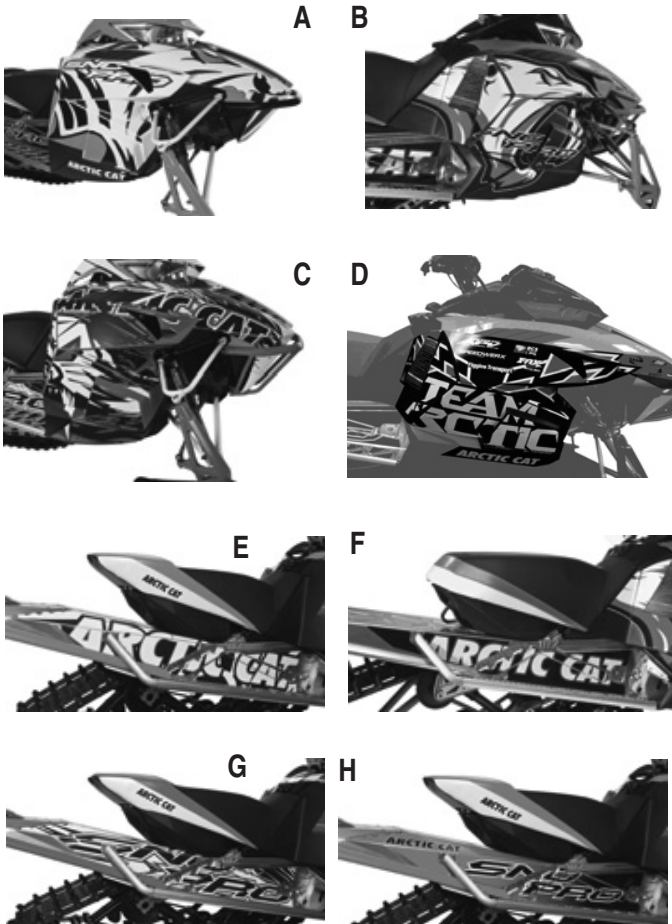

Page 110

## GRAPHIC KITS

Includes RH & LH Graphics. Fits all '12-'13 F, M, and XF models.

### Hood Graphics

	p/n
(A) Sabertooth '13 - Green	6639-065
(A) Sabertooth '13 - Orange	6639-066
(B) Sabertooth '12 - Green	5639-918
(B) Sabertooth '12 - Orange	5639-919
(C) Arctic Cat - Green	6639-063
(C) Arctic Cat - Orange	6639-064
(D) Team Arctic - Green	5639-920
(D) Team Arctic - Orange	5639-921

### Tunnel Graphics

	p/n
(E) Arctic Cat - Green	6639-092
(E) Arctic Cat - Orange	6639-093
(F) Arctic Cat - Green	5639-922
(F) Arctic Cat - Orange	5639-923
(G) Sno Pro - Green	6639-067
(G) Sno Pro - Orange	6639-068
(H) Sno Pro - Green	5639-928
(H) Sno Pro - Orange	5639-929



Page 111

## PINK ACCESSORY KITS

■ NOTE: Application specifies LXR "Black" models. Kits will also fit Green and Orange models but additional components will be required.

Application	p/n
'13 F 800 LXR, F 1100 LXR (Black)	6639-069
'13 XF 800 LXR, XF 1100 LXR (Black)	6639-070
'12 F 800 LXR, F 1100 LXR (Black)	5639-727
'12 XF 800 LXR, XF 1100 LXR (Black)	5639-728
'12 F570	5639-806
'12 F5 LXR	5639-838

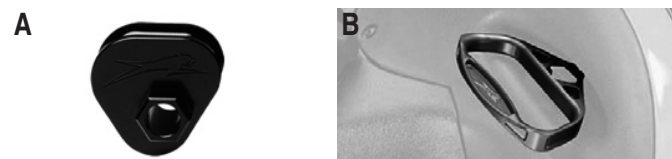

Page 112

## A. SUSPENSION BLOCKS

Application	p/n
<b>Universal</b>	
Black (Pair)	4639-853
Silver (Pair)	4639-855

## B. RECOIL HANDLE

Application	p/n
<b>Universal</b>	
Black	5639-452
Silver	5639-454

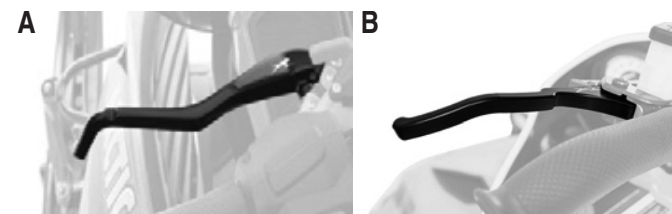

Page 112

## SNO PRO LEVER

Description	Color	p/n
(A) '12-'13 F 800, F 1100, F 1100 Turbo, M 800, M 800 HCR, M 1100, M 1100 Turbo, M 1100 Turbo HCR, XF 800, XF 800 HC, XF 1100, XF 1100 Turbo, XF 1100 Turbo HC; '12 Sno Pro 600	Black	5639-924
	Silver	5639-925
(B) '10-'13 Sno Pro 500	Black	5639-619
	Silver	5639-620

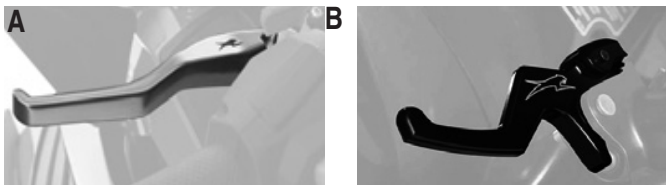

Page 112

## BRAKE LEVER

Description	Color	p/n
(A) '12-'13 F 800, F 1100, F 1100 Turbo, M 800, M 800 HCR, M 1100, M 1100 Turbo, M 1100 Turbo HCR, XF 800, XF 800 HC, XF 1100, XF 1100 Turbo, XF 1100 Turbo HC; '12 Sno Pro 600	Black	5639-736
	Silver	5639-737
(B) '12-'13 F5, F570; '07-'11 Models (Excludes Sno Pro 500)	Black	5639-505
	Silver	5639-506



Page 112

## AXLE WASHERS

Application	Color	p/n
'12-'13 F 800, F 1100, F 1100 Turbo, M 800, M 800 HCR, M 1100, M 1100 Turbo, M 1100 Turbo HCR, XF 800, XF 800 HC, XF 1100, XF 1100 Turbo, XF 1100 Turbo HC; '09-'11 M Series, M8 HCR	Black	5639-591
	Silver	5639-592



Page 112

## POD SCREWS - PAIR

Application	Color	p/n
'12-'13 F5, F570; '07-'11 F Series; '08-'13 T570, TZ1 Touring; '09-'13 BC 570; '09-'11 Z1, Z1 Turbo	Black	5639-593
	Silver	5639-594



Page 113

## HANDLEBAR GRIPS

Two 8-in. black grips. Cut to length.

Description	p/n
Black (Pair)	5639-655

■NOTE: Order Hand Guard Mounts to fit the specific model snowmobile. Then order Hand Guards to fit the mount style selected. Sno Pro Hand Guards fit mounts A, B, and C. Arctic Cat Hand Guards fit mounts D, E, and F.

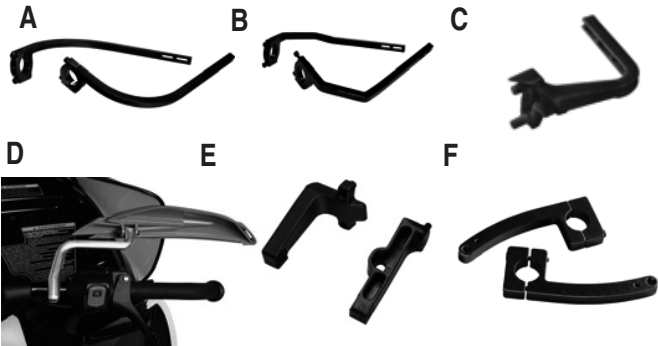

### HAND GUARD MOUNTS

Sold in pairs.

	'12-'13 F 800, F 1100 (Inc Turbo)	'12-'13 M 800, M 1100, XF 800, XF 1100 (Inc Turbo)	'10-'13 SP 500	'12 SP 600
	p/n	p/n	p/n	p/n
(A) Aluminum	5639-264		5639-264	5639-264
(B) Aluminum	6639-072		6639-072	6639-072
(C) Nylon	5639-763	5639-763		
	'12-'13 F5, F570 '09-'11 CFR '07-'11 F Series '09-'11 Z1, Z1 Turbo	'07-'11 CF '07-'11 M '09-'11 M8 HCR	'06 CF '05-'06 M '00-'02 ZR	'03-'06 FC '03-'06 ZR
	p/n	p/n	p/n	p/n
(A) Aluminum	5639-264			5639-264
(B) Aluminum	6639-072			6639-072
(C) Nylon	5639-763	5639-763		
(D) Aluminum	4639-805			4639-805
(E) Nylon	4639-804	4639-804	3639-077	3639-078
(F) Universal				3639-858

#### Replacement Hardware

For p/n 4639-804	0641-987
For p/n 5639-264, 6639-072	0641-261
For p/n 5639-763	0641-258

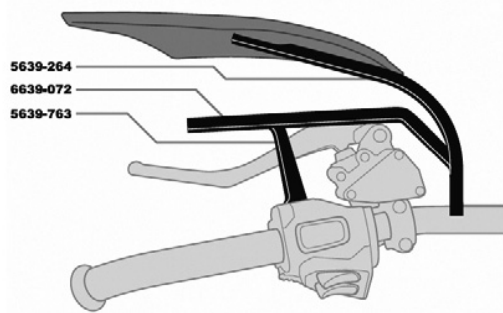

Page 113

### HAND GUARD EXTENSION

Sold in pairs. Black.

#### Application

Sno Pro Hand Guards

#### p/n

5639-263



Page 113

### SNO PRO HAND GUARDS

Sold in pairs. Mounts sold separately. Requires low windshield.

#### Description

Black  
Green  
Orange  
White  
Fits Mounts A, B, C

#### p/n

5639-581  
5639-384  
5639-261  
5639-262

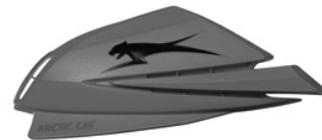

Page 113

### ARCTIC CAT HAND GUARDS

Sold in pairs. Mounts sold separately. Requires low windshield.

#### Description

Black  
Green  
Orange  
Fits Mounts D,E,F

#### p/n

4639-806  
4639-807  
4639-808

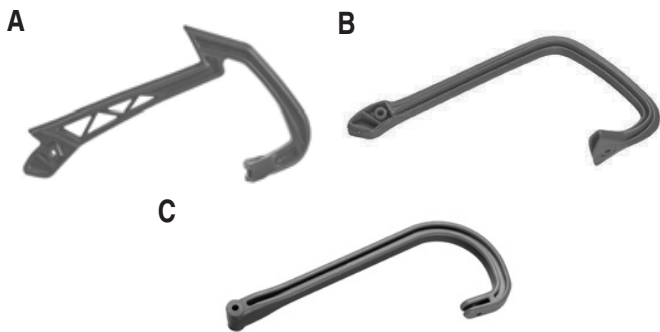

Page 114

## ARCTIC CAT SKI HANDLES

Sold in pairs.

Description	p/n
<b>(A) '12 Arctic Cat Saddleless Skis</b>	
Green	5639-743
Orange	5639-744
White	6639-095
<b>(B) '05-'11 Arctic Cat Saddleless Skis</b>	
Green	3639-777
Orange	3639-778
<b>(C) Arctic Cat &amp; Parabolic Skis</b>	
Green	3639-781
Orange	3639-865

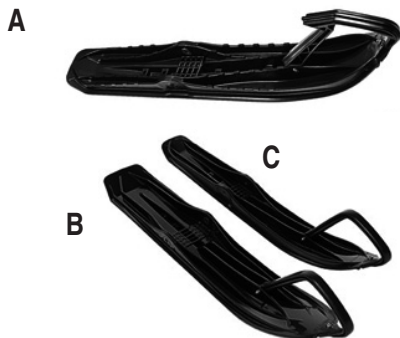

Page 114

## ARCTIC CAT SADDLELESS SKIS

Includes 4" carbides. Fits all applications ('97 & Newer Models) except cast-aluminum spindle (see Universal Plastic Skis). Sold in pairs.

Description	p/n
(A) 6" Ski Kit (Standard Keel) - Mountain Ski	5639-877
(A) 6" Ski Kit (Competition Keel) - Mountain Ski	5639-878
(B) 8" Ski Kit - Black - Trail Ski	5639-323
(C) 6" Ski Kit - Black - Trail Ski	6639-206

Replacement Wearbars (See page 49, Ref A)



Page 114

## SLP POWDER PRO SKIS™

Wearbars sold separately. Fits all applications except cast-aluminum spindle (see Universal Plastic skis). Sold in pairs.

Description	p/n
'12-'13 F, M, XF	6639-091
'07-'11 Models; '12-'13 F5, F570	5639-326

Replacement Wearbars (See page 49, Ref D)



## C&A PRO ADX SKIS

Fits all applications except cast aluminum spindles. Includes mounting hardware. Wearbars sold separately (see Universal Plastic skis). Sold in pairs.

Description	p/n
'07-'11 Models	5639-603

Replacement Wearbars (See page 49, Ref E)



## BLOW-MOLDED SKIS

Includes 4" carbides. Fits all '09 and earlier applications except cast aluminum spindle (see Universal Plastic skis). Sold in pairs.

Description	p/n
5" Ski Kit - Black	1639-575

Replacement Wearbars (See page 49, Ref C)



## UNIVERSAL PLASTIC SKIS

Fits all '09 and earlier Arctic Cat independent front suspensions. Sold in pairs.

Description	p/n
Ski Kit - Black	0639-225

Replacement Wearbars (See page 49, Ref B)

## SNOW MESH

Hood mesh not for use on Fan-Cooled Models.

p/n 5639-332

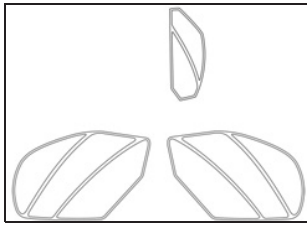

p/n 5639-352

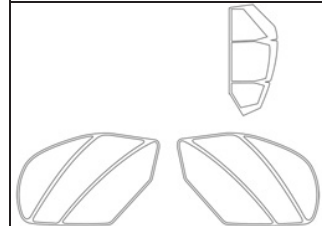

p/n 5639-169

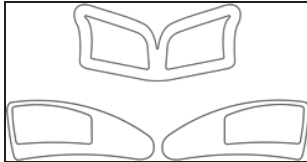

p/n 5639-333

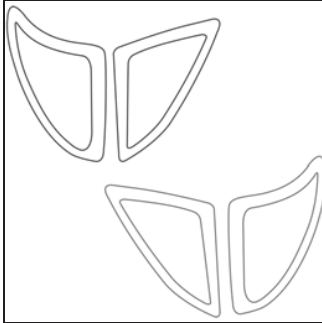

p/n 5639-458

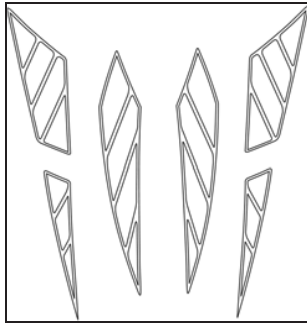

p/n 5639-334

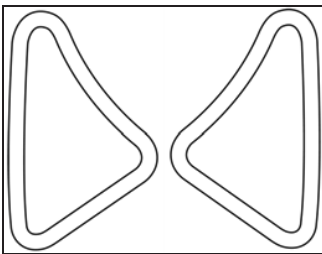

p/n 5639-396

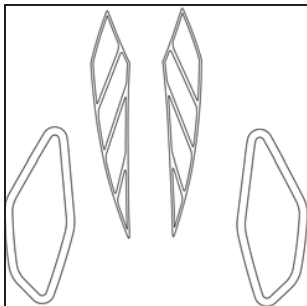

p/n 5639-499



p/n 5639-836

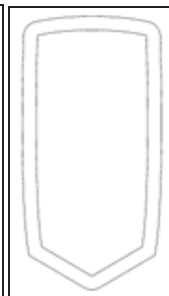

p/n 5639-633

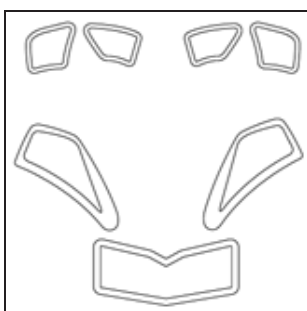

p/n 5639-835, 6639-197

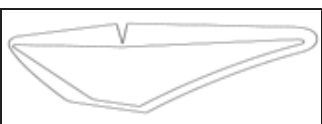

p/n 5639-947

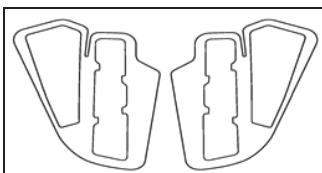

### Application

p/n

#### Bumper (Course Mesh)

'12-'13 F 1100, F 1100 Turbo, M 1100, M 1100 Turbo, M 1100 Turbo HCR, 5639-836  
XF 1100, XF 1100 Turbo, XF 1100 Turbo HC

'12-'13 F5, F570; '10-'11 F Series; '08-'13 T570, TZ1 Touring; '09-'13 BC 5639-332  
570; '09-'11 Z1

'09-'13 TZ1 Turbo Touring; '09-'11 Z1 Turbo 5639-352

'05-'11 M Series; '06-'11 CF; '09-'11 CFR, M8 HCR 5639-169

'09-'13 BC 570 XT, BC Z1 XT 5639-522

#### Hood (Course Mesh) (Liquid-Cooled Models)

'12-'13 F 800, F 1100, M 800, M 800 HCR, M 1100, XF 800, XF 800 HC, 6639-106  
XF 1100 - Center

'12-'13 F 1100 Turbo, M 1100 Turbo, M 1100 Turbo HCR, XF 1100 Turbo, 6639-111  
XF 1100 Turbo HC - Center, Removeable

'12-'13 F 800, F 1100, F 1100 Turbo, M 800, M 800 HCR, M 1100, M 1100 5639-835  
Turbo, M 1100 Turbo HCR, XF 800, XF 800 HC, XF 1100, XF 1100 Turbo,  
XF 1100 Turbo HC- LH Side Panel

'12-'13 F 800, F 1100, F 1100 Turbo, M 800, M 800 HCR, M 1100, M 1100 6639-197  
Turbo, M 1100 Turbo HCR, XF 800, XF 800 HC, XF 1100, XF 1100 Turbo,  
XF 1100 Turbo HC - RH Side Panel

'12-'13 F5; '07-'11 F Series; '08-'13 TZ1 Touring; '09-'13 BC Z1 XT; '09-'11 5639-458  
Z1 (Non-Turbo)

'05-'11 M Series; '06-'11 CF; '09-'11 CFR, M8 HCR 5639-333

'10-'13 Sno Pro 500 5639-396

'03-'06 FC, SC 5639-633

#### Intake (Fine Mesh)

'12-'13 F 800, F 1100, F 1000 Turbo, XF 800, XF 1100, XF 1100 Turbo 5639-947

'05-'11 M Series; '06-'11 CF; '09-'11 CFR, M8 HCR 5639-334

#### Side Panel, Rear (Course Mesh)

'09-'13 BC Z1 XT 5639-499

p/n 6639-106

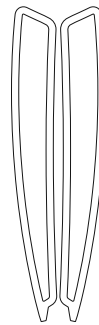

p/n 6639-111



p/n 5639-522





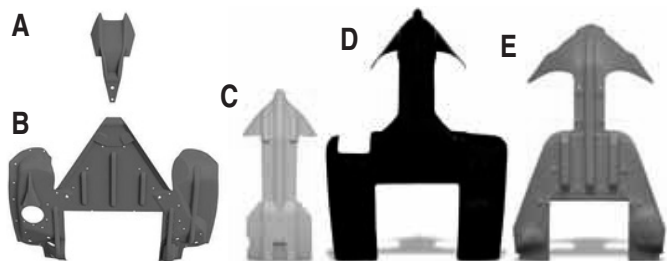

Page 115

## SKID PLATES

### Application

p/n

**(A) '12-'13 F 800, F 1100, M 800, M 800 HCR, M 1100, XF 800, XF 800 HC, XF 1100**  
**Not for use on Turbo Models or with Sport and Pro Front Bumpers**

Black - Front	5639-745
Green - Front	5639-746
Orange - Front	5639-747
White - Front	5639-748

**(B) '13 F 800, F 1100, F 1100 Turbo, M 800, M 800 HCR, M 1100, M 1100 Turbo, M 1100 Turbo HCR, XF 800, XF 800 HC, XF 1100, XF 1100 Turbo, XF 1100 Turbo HC**

Black - Rear	6639-113
Green - Rear	6639-114
Orange - Rear	6639-115
White - Rear	6639-116
Replacement Hardware	1641-007

**(C) '12 F 800, F 1100, F 1100 Turbo, M 800, M 800 HCR, M 1100, M 1100 Turbo, M 1100 Turbo HCR, XF 800, XF 800 HC, XF 1100, XF 1100 Turbo, XF 1100 Turbo HC**

Black - Rear	5639-893
Green - Rear	5639-894
Orange - Rear	5639-895
White - Rear	5639-896
Replacement Hardware	1641-007

**(D) '12-'13 F5, F570; '10-'11 F Series; '08-'13 T570, TZ1 Touring; '09-'11 Z1, Z1 Turbo; '10-'11 Z1 Turbo EXT; '11 F8 EXT**

**NOTE: '10-'11 Z1 models require trimming for exhaust outlet.**

Black	4639-567
Replacement Hardware	4639-684

**(E) '05-'11 M Series; '06-'11 CF; '09-'11 CFR, M8 HCR**

Black	3639-838
Green	3639-839
Orange	4639-564
White	5639-582
Replacement Hardware	0641-719

**(E) '05-'11 M Series; '06-'11 CF; '09-'11 CFR, M8 HCR**

Black - Heavy-Duty	5639-223
--------------------	----------

**(E) '00-'06 ZR; '01-'03 Z1; '01-'04 MC; '01-'08 Z; '04-'06 KC**

Black	1639-417
Replacement Hardware	0641-508



Page 115

## GRIP PLATES - PAIR

### Application

Color

p/n

'12-'13 F5, F570; '10-'11 F Series; '10-'11 Z1, Z1 Turbo, Z1 Turbo EXT; '11 F8 EXT

Black	5639-328
Green	5639-329
Orange	5639-330



Page 115

## GRIPPER SEAT COVER

### Application

p/n

'12-'13 F 800, F 1100, F 1100 Turbo, XF 800, XF 1100, XF 1100 Turbo	5639-845
'12-'13 M 800, M 800 HCR, M 1100, M 1100 Turbo, M 1100 Turbo HCR, XF 800 HC, XF 1100 Turbo HC	5639-846
'10-'13 Sno Pro 500	5639-667
'10-'11 M series, M8 HCR	5639-666



Page 115

## TUNNEL GRIPS

### Application

p/n

'12-'13 F 800, F 1100, F 1100 Turbo, M 800, M 800 HCR, M 1100, M 1100 Turbo, M 1100 Turbo HCR, XF 800, XF 800 HC, XF 1100, XF 1100 Turbo, XF 1100 Turbo HC	5639-839
--	----------

Universal (Pair) 4.25" x 15.5"

5639-814



Page 116

## HEADLIGHT COVERS

Not for use at night.

**NOTE:** Some states and municipalities may have laws prohibiting the use of colored headlight covers. Please check state and local laws before using headlight covers. Arctic Cat Sales Inc. shall not be liable for any claims resulting from illegal use of headlight covers

### Application

p/n

<b>'12-'13 F 800, F 1100, F 1100 Turbo, M 800, M 800 HCR, M 1100, M 1100 Turbo, M 1100 Turbo HCR, XF 800, XF 800 HC, XF 1100, XF 1100 Turbo, XF 1100 Turbo HC</b>	
Chrome	5639-753
Green Chrome	5639-754
Smoke	5639-755
<b>'12-'13 F5, F570; '07-'11 F Series; '10-'11 Z1, Z1 Turbo, Z1 Turbo EXT; '11 F8 EXT</b>	
Chrome	5639-756
Green Chrome	5639-757
Smoke	5639-758
<b>'05-'11 M Series; '06-'11 CF; '09-'11 CFR, M8 HCR</b>	
Chrome	5639-759
Green Chrome	5639-760
Smoke	5639-761
Replacement Velcro Dots (8 pc)	4639-625



Page 116

## WEAR STRIPS

Sold individually.

Application	p/n
<b>121-128"</b>	
Black	2604-257
Green	2604-819
Orange	2604-289
White	2604-543
<b>136-162"</b>	
Black	2604-799
Green	2604-821
Orange	1604-769
White	3604-832



Page 116

## SNOWFLAP

Application	p/n
<b>'12 F 800, F 1100, F 1100 Turbo, XF 800, XF 1100, XF 1100 Turbo</b>	
Green	5639-840
Orange	5639-841
<b>'12-'13 M 800, M 800 HCR, M 1100, M 1100 Turbo, M 1100 Turbo HCR, XF 800 HC, XF 1100 Turbo HC; '13 F 800, F 1100, F 1100 Turbo, XF 800, XF 1100, XF 1100 Turbo</b>	
Green	5639-842
Orange	5639-843



Page 116

## HOOD FLARES

Application	p/n
<b>'12-'13 F 800, F 1100, F 1100 Turbo, M 800, M 800 HCR, M 1100, M 1100 Turbo, M 1100 Turbo HCR, XF 800, XF 800 HC, XF 1100, XF 1100 Turbo, XF 1100 Turbo HC</b>	5639-898



Page 116

## TUNNEL FLARES

Application	p/n
<b>'12-'13 F 800, F 1100, F 1100 Turbo, M 800, M 800 HCR, M 1100, M 1100 Turbo, M 1100 Turbo HCR, XF 800, XF 800 HC, XF 1100, XF 1100 Turbo, XF 1100 Turbo HC</b>	5639-809

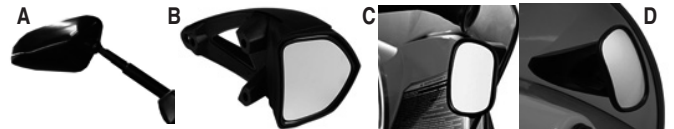

Page 117

## A. HOOD-MOUNTED MIRRORS

Application	p/n
<b>'12-'13 F 800, F 1100, F 1100 Turbo, M 800, M 800 HCR, M 1100, M 1100 Turbo, M 1100 Turbo HCR, XF 800, XF 800 HC, XF 1100, XF 1100 Turbo, XF 1100 Turbo HC</b>	
Single, RH	5639-830
Single, LH	5639-831
Pair	5639-832
Replacement Mounting Screw (Longer Thread Length)	1423-133

## B. WINDSHIELD MIRRORS

Application	p/n
<b>'12-'13 F5, F570; '10-'11 F Series; '08-'13 T570, TZ1 Touring; '09-11 BC, Z1, Z1 Turbo; '12-'13 F, M, XF Accessory Mid &amp; High Windshields</b>	
Black - Single	4639-734
Black - Pair	4639-733

## C.-D. COMPACT MIRRORS

Sold individually.

Application	p/n
(C) <b>'05-'11 M Series; '06-'11 CF; '09-'11 CFR, M8 HCR</b>	4639-463
(D) <b>'12-'13 F5, F570; '10-'11 F Series; '08-'13 T570, TZ1 Touring; '09-11 BC, Z1, Z1 Turbo</b>	4639-565





Page 117

## HAND MIRROR

**Description**  
Hand Mirror **p/n**  
4992-810



## A-ARM DEFLECTORS

**Description**  
'12-'13 F5, F570; '10-'11 F Series; '08-'13 T570, TZ1 Touring; '09-'13 BC 570; '09-'11 Z1 **p/n**  
4639-897



## TOE HOLD

Sold in pairs.

**Application**  
'10-'13 Sno Pro 500 **p/n**  
5639-611



## RECOIL HANDLE

**Application**  
Black 0636-363  
Green 3639-866  
Orange 3639-867 **p/n**



## WHEELS (IDLER WHEELS)

Includes bearing. Sold individually.

Description	p/n	Description	p/n
<b>(A) 5.63" x .787" ID</b>		<b>(A) 7.12" x .787" ID</b>	
Black	3604-386	Black	3604-063
Green	3604-047	Green	3604-066
Orange	3604-048	Orange	3604-065
Pink	3604-379	Pink	3604-380
Red	3604-044	Red	3604-064
Silver	3604-043	Silver	3604-062
Yellow	3604-040	Yellow	3604-068
<b>(A) 5.63" x .625" ID</b>		<b>(A) 7.12" x .625" ID</b>	
Green	1604-691	Black	1604-683
Silver	1604-693	Green	1604-745
Yellow	2604-122	Silver	1604-971
<b>(A) 6.38" x .625" ID</b>		<b>(B) 8.00" x .787" ID</b>	
Green	1604-692	Black	3604-073
Orange	1604-765	Green	3604-075
Red	1604-767	Orange	3604-071
Silver	1604-694	Red	3604-074
		Silver	3604-076
<b>(A) 6.38" x .787" ID</b>		<b>(C) 5.63" x .625" ID</b>	
Black	3604-387		
Green	3604-053	Green	0604-981
Orange	3604-054	<b>(C) 6.38" x .625" ID</b>	
Red	3604-052	Green	0604-980
Silver	3604-055		

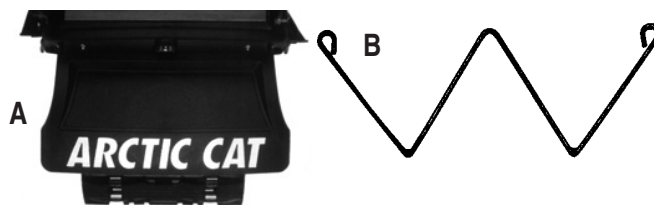

## A. SHORT SNOWFLAP

**Application**  
'99-'06 121" Models 1606-507  
Models prior to '99 0616-613 **p/n**

## B. SNOWFLAP SUPPORT BRACKET

**Application**  
'99-'06 121" Models 2706-648 **p/n**

# Mountain Accessories

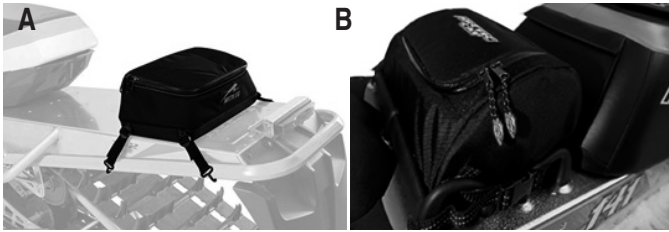

Page 119

## MOUNTAIN PACK

Application	p/n
(A) '12-'13 M 800, M 800 HCR, M 1100, M 1100 Turbo, M 1100 Turbo HCR, XF 800, XF 800 HC, XF 1100, XF 1100 Turbo, XF 1100 Turbo HC; '09-'11 M Series, M8 HCR	5639-710
(B) '05-'08 M Series; '06-'08 CF	3639-725
<b>Replacement Hardware</b>	
Repl Strap w/Hook, Pk/4 (5639-710)	0641-994



Page 119

## MOUNTAIN GEAR BAG

Application	p/n
(A) '12-'13 M 800, M 800 HCR, M 1100, M 1100 Turbo, M 1100 Turbo HCR, XF 800, XF 800 HC, XF 1100, XF 1100 Turbo, XF 1100 Turbo HC; '09-'11 M Series, M8 HCR	5639-711
(B) '09-'11 M Series, M8 HCR	5639-044
(C) '05-'08 M Series; '06-'08 CF	4639-727
<b>Replacement Hardware</b>	
Repl Strap w/Hook, Pk/4 (5639-044, 5639-711)	0641-994
Repl Cam Buckle, Pair (4639-727)	1639-248

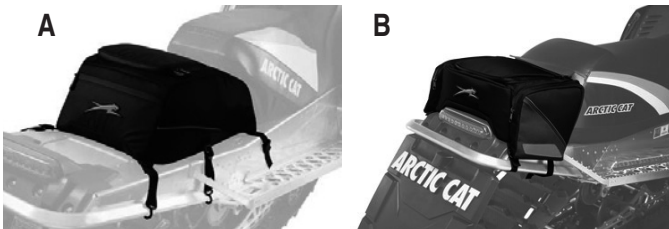

Page 119

## TUNNEL GEAR BAG

Application	p/n
(A) '12-'13 F5, F570; '10-'11 F Series, M Series, Z1, Z1 Turbo, Z1 Turbo EXT; '11 F8 EXT	5639-574
(B) '09-'11 M Series, CF, CFR, M8 HCR	5639-043
<b>Replacement Hardware</b>	
Repl Strap w/Hook, Pk/4 (5639-043, 5639-574)	0641-994
Repl Cam Buckle, Pair (5639-574)	0639-089

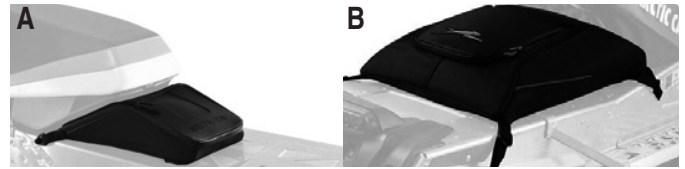

Page 119

## TUNNEL PACK

Application	p/n
(A) '12-'13 F 800, F 1100, F 1100 Turbo, M 800, M 800 HCR, M 1100, M 1100 Turbo, M 1100 Turbo HCR, XF 800, XF 800 HC, XF 1100, XF 1100 Turbo, XF 1100 Turbo HC	6639-183
(B) '10-'13 Sno Pro 500; '10-'11 M Series	5639-433
<b>Replacement Hardware</b>	
Repl Spool w/Rivet, Pair (6639-183)	6639-154
Repl Front Clip, Pair (6639-183)	6639-155
Repl Strap w/Hook, Pk/4 (5639-433)	0641-994



Page 119

## HANDLEBAR BAG

Application	p/n
'12-'13 M 800, M 800 HCR, M 1100, M 1100 Turbo, M 1100 Turbo HCR, XF 800, XF 800 HC, XF 1100, XF 1100 Turbo, XF 1100 Turbo HC; '09-'13 BC 570, BC XT; '05-'11 M Series; '06-'11 CF	5639-709



Page 120

## TANK PADS

Sold in pairs.

Application	p/n
<b>(A) '12-'13 F 800, F 1100, F 1100 Turbo, M 800, M 800 HCR, M 1100, M 1100 Turbo, M 1100 Turbo HCR, XF 800, XF 800 HC, XF 1100, XF 1100 Turbo, XF 1100 Turbo HC</b>	
Black	5639-764
Green	5639-765
Orange	5639-766
White	6639-096
Plastic Rivets (6/pk)	5639-930
<b>(B) '05-'11 M Series; '06-'11 CF; '09-'11 CFR, M8 HCR</b>	
Black	5639-050
Green	5639-051
Orange	5639-052
Replacement Mounting Screw '05-'07 (Std)	8017-427
Replacement Mounting Screw '08-'11 (Metric)	8475-512
<b>(C) '10-'13 Sno Pro 500</b>	
Black	5639-612



Page 120

## TANK GRIPS

### Application

'12-'13 F 800, F 1100, F 1100 Turbo, M 800, M 800 HCR, M 1100 M 1100 Turbo, M 1100 Turbo HCR, XF 800, XF 800 HC, XF 1100, XF 1100 Turbo, XF 1100 Turbo HC

p/n

5639-762



Page 120

## WINDSHIELD BAG

### Application

'12-'13 F 800, F 1100, F 1100 Turbo, M 800, M 800 HCR, M 1100, M 1100 Turbo, M 1100 Turbo HCR, XF 800, XF 800 HC, XF 1100, XF 1100 Turbo, XF 1100 Turbo HC

p/n

5639-712

'12-'13 F, M, XF With Accessory Mid & High Windshields 5639-799, 5639-800, 5639-801, 5639-916, 5639-917

6639-051

'05-'11 M Series; '06-'11 CF; '09-'11 CFR, M8 HCR

4639-428



Page 120

## GOGGLE HOLDER

**CAUTION:** Do not leave goggles in holder for an extended period of time. Excessive heat may damage goggles.

### Application

(A) '12-'13 F 800, F 1100, F 1100 Turbo, M 800, M 800 HCR, M 1100, M 1100 Turbo, M 1100 Turbo HCR, XF 800, XF 800 HC, XF 1100, XF 1100 Turbo, XF 1100 Turbo HC

p/n

5639-767

(B) '05-'11 M Series; '06-'11 CF; '09-'11 CFR, M8 HCR

4639-732

### Replacement Hardware

Latch Repair Kit (5639-767)

6639-076

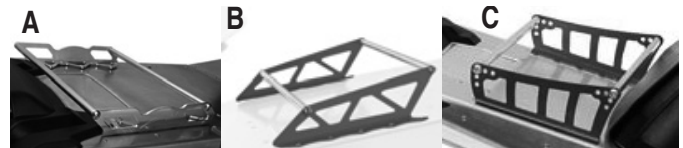

Page 121

## A. BILLET RACK

8" x 13" W

### Application

'12-'13 M 800, M 800 HCR, M 1100, M 1100 Turbo, M 1100 Turbo HCR, XF 800 HC, XF 1100 Turbo HC; '13 F 800, F 1100, F 1100 Turbo, XF 800, XF 1100, XF 1100 Turbo; '09-'11 M Series, M8 HCR

p/n

Black  
Silver

5639-597  
5639-598

## B. PROCLIMB RACK

8" x 12" W

### Application

'12-'13 M 800, M 800 HCR, M 1100, M 1100 Turbo, M 1100 Turbo HCR, XF 800 HC, XF 1100 Turbo HC; '13 F 800, F 1100, F 1100 Turbo, XF 800, XF 1100, XF 1100 Turbo

p/n

Black  
Green  
Orange  
Silver

6639-159  
5639-773  
5639-774  
5639-775

## C. M SERIES RACK

8 3/4" x 15" W

### Application

'09-'11 M Series, M8 HCR

p/n

Green  
Orange  
Unpainted

4639-975  
4639-976  
4639-977



Page 121

## RACK STRAP

### Application

(A) '12-'13 M 800, M 800 HCR, M 1100, M 1100 Turbo, M 1100 Turbo HCR, XF 800, XF 800 HC, XF 1100, XF 1100 Turbo, XF 1100 Turbo HC; '09-'11 M Series, M8 HCR, CF  
(B) '05-'08 M Series; '06-'08 CF

p/n

4639-978

3639-579



Page 121

## MOUNTAIN SEAT

### Application

'05-'09 M Series; '06-'11 CF; '09-'11 CFR

Color

p/n

Black 5639-600  
Green 5639-601  
Orange 5639-602



Page 121

## BEARD MOUNTAIN SEAT

**Application**

'05-'11 M Series; '06-'11 CF; '09-'11 CFR

**p/n**

5639-875



Page 122

## FLOAT THROTTLE AVALANCHE AIRBAG

For technical assistance, contact BCA at 303-417-1345, ext. 0. Includes pressurized air cylinder, requires hazardous material shipping.

**Description**

Float Throttle

**BCA online resources**

**p/n**

6639-107



Page 122

## AVALANCHE BEACONS

For technical assistance contact: BCA at 303-417-1345, ext. 0.

**Description**

BCA Tracker2 (457 kHz)

**BCA online resources**

**p/n**

5639-610



Page 122

## BACKCOUNTRY KIT

**Description**

BCA Squall Backpack, Tracker2 Beacon, B-1 Ext Shovel, Stealth 240 Probe

**p/n**

6639-109



Page 123

## BACKPACKS

**Description**

(A) BCA Squall w/Hydration - 2.0 lbs, 27 Liter capacity  
 (B) BCA Throttle w/Hydration - 3.3 lbs, 35 Liter capacity  
 (C) Ogio Capital - 2.6 lbs, 34 Liter capacity

**p/n**

5639-769  
 5639-653  
 5639-432

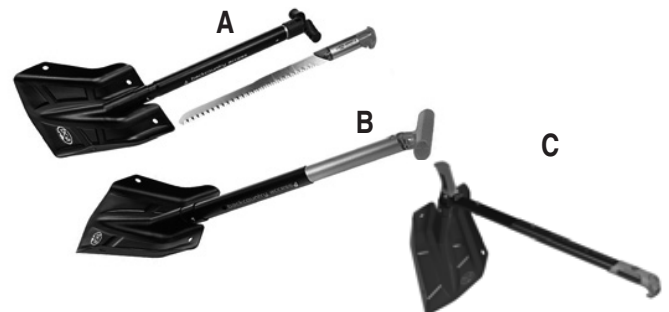

Page 123

## SNOW SHOVELS

**Description**

(A) BCA A-2 EXT with Saw (Extendable handle)  
 (B) BCA B-1 EXT (Extendable handle)  
 (C) BCA Dozer (Converts to Shovel or Hoe)

**p/n**

5639-786  
 5639-770  
 6639-108

**BCA online resources**

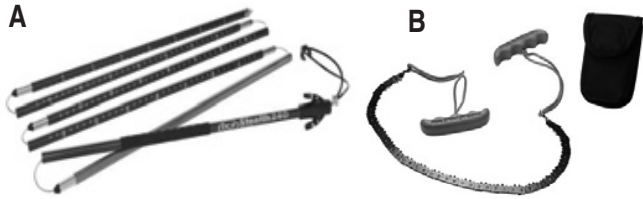

Page 123

## A. AVALANCHE PROBE

**Description**  
BCA Stealth 240  
**BCA online resources**

**p/n**  
6639-110

## B. POCKET SAW

**Application**  
Saw with Pouch

**p/n**  
4639-979



Page 124

## ICE SCRATCHERS

■Note: Ice Scratchers can be used on most Arctic Cat models. They must be mounted in a location that will not contact idler wheels or suspension arms. Mounting holes may need to be drilled in the rails.

**Application**  
'12-'13 M 800, M 1100, M 1100 Turbo, XF 800, XF 800 HC, XF 1100, XF 1100 Turbo, XF 1100 turbo HC; '09-'11 M Series, M8 HCR, CF

**p/n**  
5639-897

### Replacement Components

Wire - RH 1704-734  
Wire - LH 1704-735  
Mounting Hardware (Pair) 5639-941



Page 124

## VENTED HOOD PANELS

**Description**  
'12-'13 F 800, F 1100, F 1100 Turbo, M 800, M 800 HCR, M 1100, M 1100 Turbo, M 1100 Turbo HCR, XF 800, XF 800 HC, XF 1100, XF 1100 Turbo, XF 1100 Turbo HC

**p/n**

### Hood Panel Kit with Screens (Pair)

Black 5639-862  
Green 5639-863  
Orange 5639-864  
White 5639-991

### Screen Set Only (Pair)

Hood Screens 5639-948

### Replacement Screens (Each)

Hood Screen - RH 6606-468  
Hood Screen - LH 6606-469

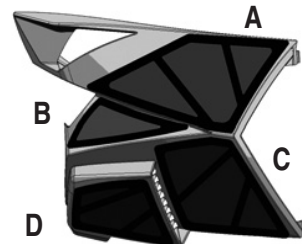

Page 124

## VENTED SIDE PANELS

### Description

'12-'13 F 800, F 1100, F 1100 Turbo, M 800, M 800 HCR, M 1100, M 1100 Turbo, M 1100 Turbo HCR, XF 800, XF 800 HC, XF 1100, XF 1100 Turbo, XF 1100 Turbo HC

**p/n**

### Side Panel Kit with Screens (Pair)

Black 5639-865  
Green 5639-866  
White 6639-084

### Screen Set Only (Set of 7)

Side Panel Screens 5639-949

### Replacement Screens (Each)

(A) Upper - RH 6606-470  
(A) Upper - LH 6606-471  
(B) Mid - LH 6606-485  
(C) Lower, Rear - RH 6606-474  
(C) Lower, Rear - LH 6606-475  
(D) Lower, Front - RH 6606-472  
(D) Lower, Front - LH 6606-473



Page 125

## SWITCH GUARDS

### Application

'12-'13 M 800, M 800 HCR, M 1100, M 1100 Turbo, M 1100 Turbo HCR, XF 800, XF 800 HC, XF 1100, XF 1100 Turbo, XF 1100 Turbo HC; '07-'11 M Series; '09-'11 M8 HCR

**p/n**

5639-580



Page 125

## VERTICAL STEERING POST KIT

### Application

'12-'13 F 1100, F 1100 Turbo, M 800 (Std), XF 1100, XF 1100 Turbo; '12 M 1100, M 1100 Turbo, M 1100 Turbo HCR; '13 M 1100 (Std), M 1100 Turbo (Std)

**p/n**

5639-945



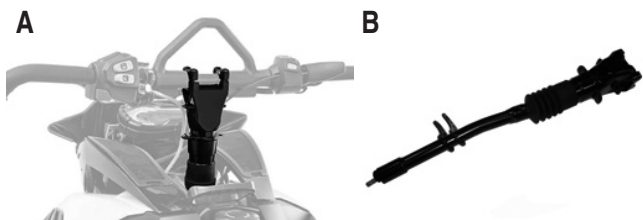

Page 125

### TELESCOPIC STEERING POST

NOTE: Not available for CF5 - insufficient cable length.

Application	p/n
(A) '12-'13 F 800, XF 800, M 800 (Std)	5639-813
(B) '09-'11 M Series (Std), CF (Std)	5639-516



### OFFSET RISER

Application	p/n
'09-'11 M Series; M8 HCR w/Telescopic Post	
Black	5639-595
Silver	5639-596

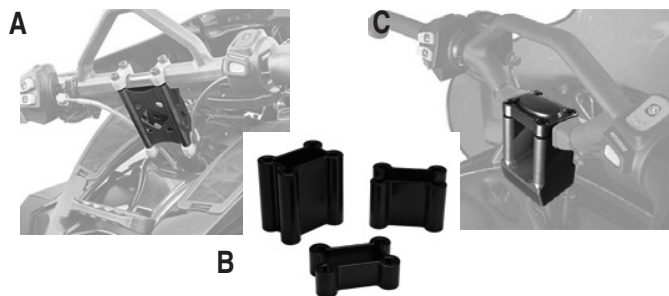

Page 125

### A. HANDLEBAR RISERS

Application	p/n
'12-'13 F 800, F 1100, F 1100 Turbo, M 800 (Std), M 1100, M 1100 Turbo, XF 800, XF 1100, XF 1100 Turbo	
2.0" - Unpainted	1605-086
3.0" - Unpainted	1605-063
4.5" - Unpainted	1605-035
6.5" - Unpainted	1605-034
2.0" - Black	1705-454
4.5" - Black	5639-881
5.5" - Black	5639-882
6.5" - Black	5639-883
7.5" - Black	5639-884
8.5" - Black	5639-885
4.5" - Green	5639-886
5.5" - Green	5639-887
6.5" - Green	5639-888
7.5" - Green	5639-889
8.5" - Green	5639-890

### B. HANDLEBAR RISERS

Application	p/n
'05-'11 M Series (Std); '06-'11 CF (Std)	
1" - Black	5639-776
2" - Black	5639-777
3" - Black	5639-778

### C. ANGLED HANDLEBAR RISER

Application	p/n
'05-'11 M Series (Std); '06-'11 CF (Std)	
2" - Silver	5639-503
3" - Silver	5639-504

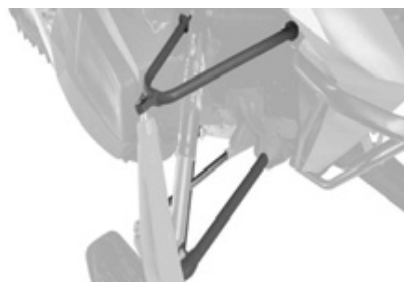

Page 126

### NARROW A-ARM KIT

Application	p/n
'12 M 800 (Std), M 800 SP, M 1100 (Std), M 1100 SP, M 1100 Turbo (Std), M 1100 Turbo SP, M 1100 Turbo HCR	
	5639-938
	5639-939
	5639-940

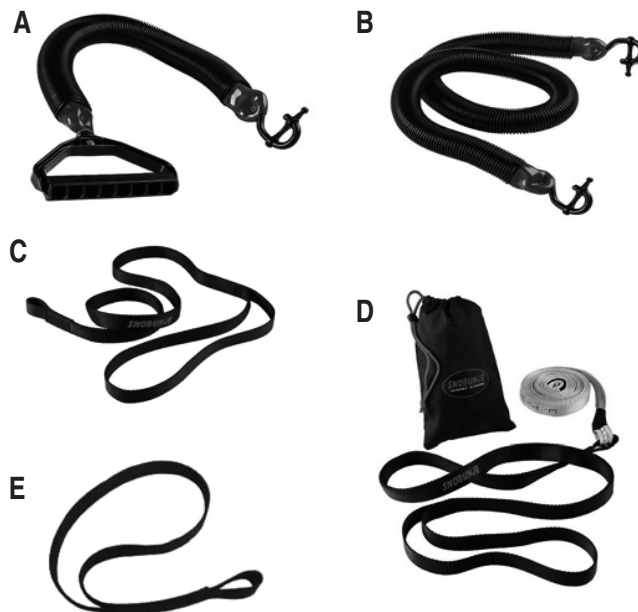

Page 126

### SNOBUNJE PULLING TOOLS

Description	p/n
(A) Rattler (32" Long, 1.5 lbs)	5639-639
(B) Cobra (52" Long, 2.5 lbs)	5639-640
(C) Adapter Strap (60" Long)	5639-642
(D) Slicktape 20 (20' Long)	5639-643
(E) Cobra Adapter Strap (15" Long)	5639-641





## PULL STRAP

**Description**  
Pull Strap

**p/n**  
5639-512



## MOUNTAIN STRAP

**Application**  
'10-'11 Z1 Turbo EXT; '11 F8 EXT

**p/n**  
5639-358



Page 126

## HI-TEMP CAM ROLLER

Set of 6.

**Application**  
ACT Driven Pulley

**p/n**  
5639-990



## A. FOUR WHEEL KIT

Adds two inside wheels.

**Application**  
'09-'11 M Series

**p/n**  
5639-528

## B. TWO WHEEL KIT

**Application**  
'08 M Series; '09-'11 CF  
\* '05-'07 M Series, '04 MC, '04-'06 KC  
\* Requires Spacer (p/n 1604-810)

**p/n**  
4639-997



Page 126

## LIGHTWEIGHT FRONT AXLE KIT

**Application**  
'05-'08 M Series

**p/n**  
4639-995



## RACK PAD

**Application**  
'09-'11 M Series, M8 HCR, CF (12.75-in. Long) 4639-988  
'10-'11 F Series, Z1, Z1 Turbo, Z1 Turbo EXT; '11 F8 EXT (21-in. Long) 5639-351



## TUNNEL FLARES

**Application**  
'09-'11 M Series, M8 HCR, CF, CFR  
Black

**p/n**  
5639-107

---

## Utility

---



Page 127

### BEARCAT GEAR BAG

**Application**  
'09-'13 BC 570 XT, BC Z1 XT

**p/n**  
5639-049

---



Page 127

### TUNNEL PACK

**Application**  
'09-'13 BC 570 XT, BC Z1 XT

**p/n**  
6606-252

---



Page 127

### THIRD SEAT

**Application**  
'09-'13 BC 570 XT, BC Z1 XT

**p/n**  
5639-063

---



Page 128

### BACKUP LIGHT KIT

**Application**  
'09-'13 BC Z1 XT

**p/n**  
5639-389

---



Page 128

### CARGO RACK

**Application**  
'09-'13 BC 570 XT, BC Z1 XT

**p/n**  
5639-062

---

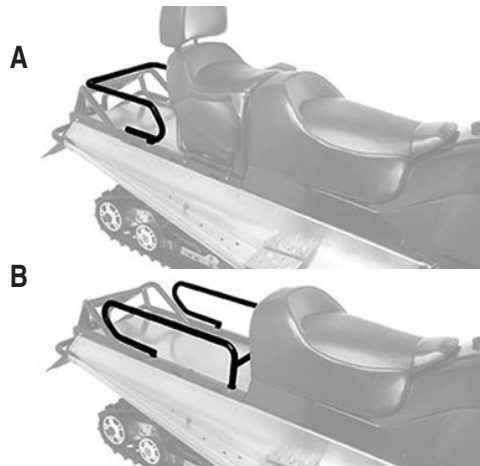

Page 128

### SIDE RAILS

**Application**  
'09-'13 BC 570 XT, BC Z1 XT  
(A) Short  
(B) Long

**p/n**  
5639-060  
5639-061

Replacement Strap ea (5639-060)

0641-993

---



**Page 128**  
**LIGHT BAR**

**Application** '09-'13 BC 570 XT, BC Z1 XT **p/n** 5639-803



**Page 128**  
**STROBE LIGHT**

**Application** Fits Light Bar (5639-803) **p/n** 5639-871

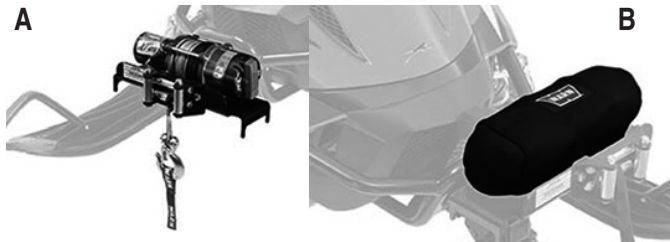

**Page 129**  
**RECEIVER WINCH**

**Application** (A) '09-'13 BC 570 XT, BC Z1 XT 5639-340  
(B) Winch Cover 5639-459

**Replacement Components**

Fairlead, Roller	0441-403
Mounting Pin	1441-977
Mounting Pin Clip	1441-143
Mounting Plate 2" Receiver	0641-256
Solenoid	0409-080
Switch, Handlebar	0641-249



**Page 129**  
**REAR HARNESS**

**Application** '09-'13 BC 570 XT, BC Z1 XT **p/n** 5639-456



**Page 129**  
**TRANSPORT MOUNT**

**Application** '09-'13 BC 570 XT, BC Z1 XT **p/n** 5639-457



**Page 129**  
**WARN XT17 PORTABLE WINCH KIT**

**Description** Models With Standard Battery 6639-073

**Replacement Components**

Switch Assembly w/Harness	1641-009
Power Lead, Battery	1641-010
Power Lead, Extension	1641-011
Hook Strap	1641-012



Page 129

## WINCH STOW PLATE

### Description

Portable Winch (6639-073)  
Replacement Pin

p/n  
6639-074  
1641-013



Page 130

## CARGO SLEDS

Additional shipping charges may apply. Order in multiples of 3.

### Description

74" L X 38" W X 17" D, 48 lb, Capacity - 600 lb

p/n  
4639-126



Page 130

## CARGO SLED RUNNER KIT

### Application

Cargo Sled (4639-126) 6 Wearstrips

p/n  
4639-131



Page 130

## CARGO SLED COVER

Attaches with elastic cord.

### Application

Cargo Sled (4639-126)

p/n  
4639-129

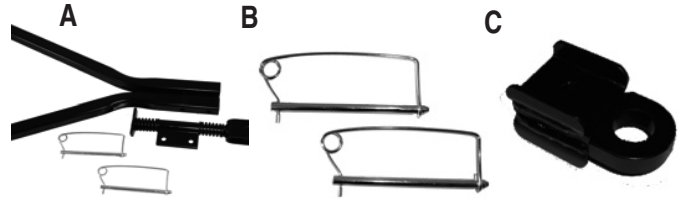

## REPLACEMENT HARDWARE

### Description

(A) Replacement Hitch  
(B) Replacement Pins (Pair)  
(C) Pintle Hitch Adapter

p/n  
4639-941  
5639-236  
5639-463

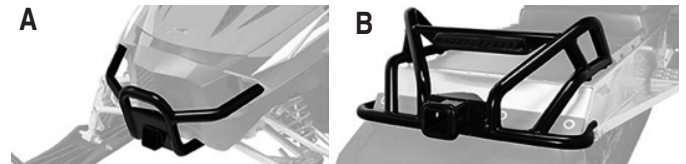

Page 131

## RECEIVER BUMPER

### Application

'09-'13 BC 570 XT, BC Z1 XT

(A) Front  
(B) Rear  
Replacement Hitch Cover

p/n

5639-338  
5639-339  
0641-248



Page 131

## A. HITCH

Pintle hitch not included. Accepts Pintle Hitch (p/n 4606-156)

### Application

'09-'13 BC XT - Receiver Bumper (p/n 5639-339)

p/n  
5639-386

## B. PIVOT HITCH

### Application

'09-'13 BC 570 XT, BC Z1 XT; '06-'07 BC WT; '07 BC 570

p/n  
5639-387



Page 131

## SKI SKINS

Fits 8" Saddleless Skis. 12" wide. Sold in pairs.

### Application

'09-'13 BC 570, BC 570 XT, BC Z1 XT

p/n  
5639-254



## PASSENGER HAND WARMERS

■NOTE: Not available for fan-cooled models - power output insufficient.

Application	p/n
(A) '09-'13 BC Z1 XT; '11-'12 BC Z1 XT LTDLTD	4639-970
(B) '08-'09 T500	4639-802



## RACK MAT

Application	p/n
'09-'13 BC 570 XT, BC Z1 XT	5606-368



Page 131

## SNOW PLOW PUSH FRAME

Requires Front Receiver Bumper and Receiver Winch.

Application	p/n
'09-'13 BC 570 XT, BC Z1 XT	5639-341
<b>Replacement Components</b>	
Eyebolt	0441-332
Mounting Pin	1441-977
Mounting Pin Clip	1441-143
Spring - Kickover	0741-009

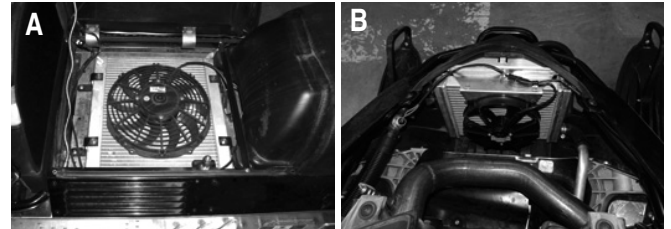

## RADIATOR KIT

Includes radiator with electric cooling fan, hoses, and wiring.

Application	p/n
(A) '09-'13 BC Z1 XT (Under Seat)	4639-967
(B) '09-'13 BC Z1 XT (Front)	6639-180

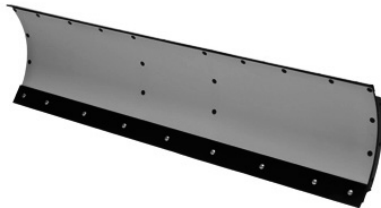

Page 131

## SNOW PLOW BLADE

60" Blade.

Application	p/n
Fits Snowplow Push Frame (5639-341)	0436-296
<b>Optional Accessories</b>	
Edge Marker Kit	0436-235
Side Plate Kit	0436-232
Snow Deflector	0436-299
<b>Replacement Components</b>	
Skid	0441-341
Wearbar	0441-447



## LOW RATIO GEAR SET

Includes input gear and fully assembled planetary ring gear assembly. Uses 4 pinion straight cut gears for strength and reliability. Drive away is just over 4 mph with a top speed of 57 mph.

Application	p/n
'12-'13 BC Z1 XT GS; '09-'13 BC Z1 XT	6639-190

■NOTE: For more information on the Gear Exchange Program, see page 1.



## PASSENGER SEAT KIT

Includes seat assembly with backrest.

**Application**  
'09-'10 BC 570

**p/n**  
5639-201



## OVERLOAD SPRING KIT

**Application**  
'09-'10 BC 570

**p/n**  
5639-106

# Bearcat Trail Groomer

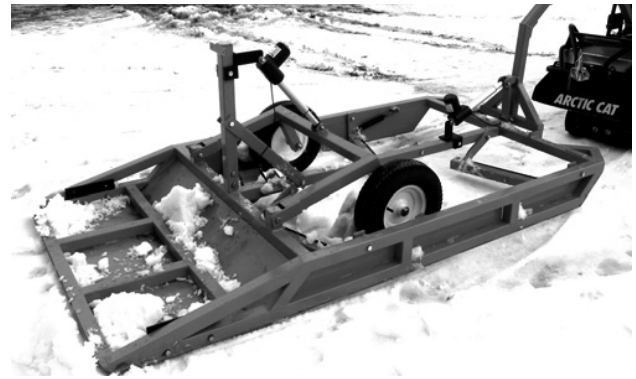

The Bearcat Trail Groomer is designed to maintain a 4-ft wide trail

- Two electric actuators that control cutting depth and wheel lift are pre-wired for the Bearcat Z1 XT GS rear outlet
- Four spring-loaded, pivoting cutting edges (front two are serrated) ('12-'13 Bearcat Z1 XT models have pre-drilled mounting holes, '09-'11 models require drilling)
- Goose-neck hitch features an anti-scalping design
- Includes a snowmobile hitch plate with 1-7/8-in. ball that bolts directly to pre-drilled tunnel rails
- 52-in. x 96-in., 350 lb

■NOTE: The '12-'13 Bearcat Z1 XT GS has an under-seat radiator and Groomer switches and outlet factory-installed. All other '09-'13 Bearcat Z1 XT models require a Radiator Kit (page 45) and Groomer Harness Kit when pulling a Trail Groomer.

Description	Application	p/n
Trail Groomer w/Mounting Plate & Ball	'12-'13 BC Z1 XT GS	5639-891
Groomer Harness Kit*	'09-'13 BC Z1 XT	5639-876
<b>Replacement Components</b>		
Hitch Plate w/Ball		5639-931
Lift Actuator		5639-932

\*Includes dash-mounted control switches, wiring harness, and rear outlet



# Tracks

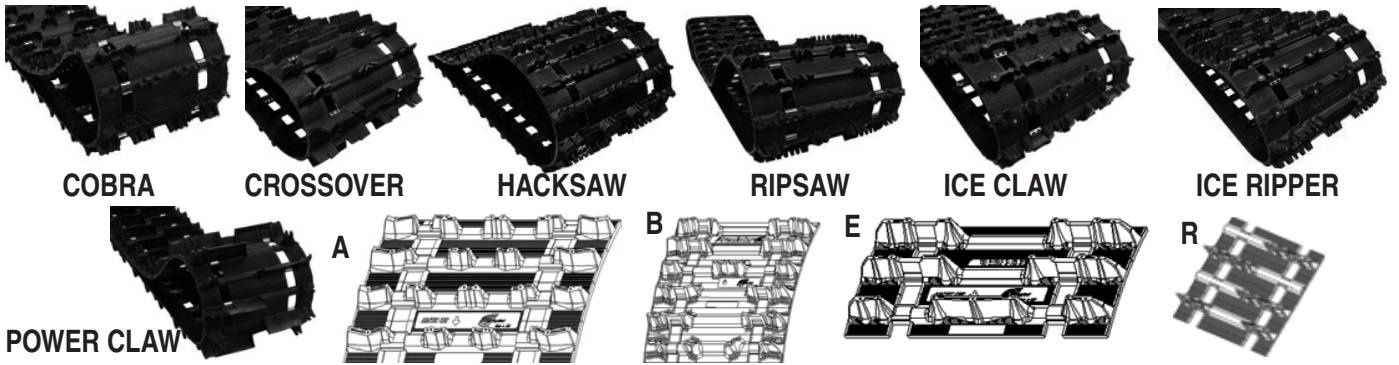

Page 133

## TRACKS - 2007-CURRENT APPLICATIONS

Tracks listed are required for use on 2007 and newer models with ACT drive and reverse but will also fit older models. All tracks listed feature an "All Open" window configuration with 2-ply construction unless noted. Pitch is measured at center of rods.

### PERFORMANCE (2.52 P)

p/n	Dimensions (Studs)	Style	Duro	Weight	Clips
*1602-976	15" x 121" x 1.00"	Hacksaw	80/70	33	Every 3rd
*2602-268	15" x 121" x 1.352"	Cobra (Single-Ply)***	80	32	Every Other
*2602-002	15" x 121" x 1.25"	Ripsaw	80/70	36	Every 3rd
*2602-047	14" x 128" x 1.00"	Hacksaw	80/70	34	Every 3rd
*2602-019	15" x 128" x 1.00"	Hacksaw	80/70	36	Every 3rd
*2602-162	15" x 128" x 1.352"	Cobra***	80	37	Every Other
*2602-255	15" x 128" x 1.352"	Cobra (Single-Ply)***	80	34	Every 3rd
*2602-046	15" x 128" x 1.25"	Ripsaw	80/70	41	Every 3rd
*2602-835	15" x 128" x 1.50"	Ripsaw	80/70	42	Every 3rd
*1602-997	15" x 136" x 1.25"	Ripsaw	80/70	42	Every 3rd
*2602-005	15" x 136" x 1.50"	Ripsaw	80/70	42	Every 3rd

### PERFORMANCE (2.86 P)

*2602-575	15" x 129" x 1.00"	Ripsaw II	80/70	34	Every Other
2602-503	15" x 129" x 1.00"	Ripsaw II	80/70	34	Every Other
*2602-576	15" x 129" x 1.25"	Ripsaw	80/70	40	Every Other
2602-474	15" x 129" x 1.25"	Ripsaw	80/70	40	Every Other
2602-490	15" x 129" x 1.25"	Ripsaw II	80/70	40	Every Other
*2602-577	15" x 129" x 1.352"	Cobra***	80/70	36	Every Other
2602-491	15" x 129" x 1.352"	Cobra***	80/70	36	Every Other
2602-485	15" x 129" x 1.70"	Sno Pro	80/70	42	Every Other

### TOURING (2.52 P)

2602-528	15" x 136" x 1.00"	Hacksaw	80/70	37	Every 3rd
*2602-101	15" x 144" x 1.00"	Hacksaw	80/70	40	Every 3rd
*2602-163	15" x 144" x 1.352"	Cobra	80	41	Every Other
*2602-350	15" x 144" x 1.50"	Crossover (Single-Ply)	80	47	Every 3rd

### MOUNTAIN TRACKS (3.0 P)

2602-169	15" x 141" x 1.352"	Cobra (Single-Ply)***	80	38	Every Other
2602-170	15" x 141" x 1.60"	Cobra (Single-Ply)	80	40	Every Other
2602-166	15" x 141" x 2.25"	Power Claw (Single-Ply)	80	44	Every Other
2602-167	15" x 153" x 2.25"	Power Claw (Single-Ply)	80	48	Every Other
2602-399	15" x 153" x 2.25"	Power Claw (Single-Ply)	85	48	Every Other
2602-481	15" x 153" x 2.60"	Power Claw (Single-Ply)	80	50	Every Other
2602-482	15" x 153" x 2.60"	Power Claw (Single-Ply)	85	50	Every Other
2602-168	15" x 162" x 2.25"	Power Claw (Single-Ply)	80	50	Every Other
2602-367	15" x 162" x 2.25"	Power Claw (Single-Ply) (Notched)	80	48	Every Other
2602-438	15" x 162" x 2.25"	Power Claw (Single-Ply)	85	50	Every Other
2602-483	15" x 162" x 2.60"	Power Claw (Single-Ply)	80	52	Every Other
2602-484	15" x 162" x 2.60"	Power Claw (Single-Ply)	85	52	Every Other

### UTILITY (2.52 P)

2602-314	15" x 151" x 1.25"	Ripsaw (Single-Ply)	80	45	Every 3rd
0602-962	20" x 156" x 1.00"		60	63	Fully Clipped
1602-869	20" x 156" x 1.25"		80	67	Fully Clipped

### UTILITY (2.86 P)

2602-358 20" x 154" x 1.375" (Single-Ply) 80/70 58 Every 3rd

### ICE TECH SERIES (2.52 P)\*\*

\*2602-032 15" x 121" x 1.25" ICE Ripper 70 37 Every 3rd

2602-376 15" x 128" x 1.25" ICE Ripper 70 39 Every 3rd

(258)

(272)

### ICE TECH SERIES (2.86 P)\*\*

2602-598 15" x 129" x 1.25" ICE Ripper 80/70 42 Every Other

(240)

\* ACT Quiet Tracks are for use on '03 and newer models only.

\*\*To protect the tunnel from possible stud damage, a Tunnel Protector Kit (page 55) should be installed on models not equipped

\*\*\*Cobra 1.352" tracks have a standard lug height of 1.25". The overall lug height including the extended "towers" is 1.352".

## 2009-2013 TRACK APPLICATION

Model	Year	Single-Ply	2-Ply
Bearcat 570	'10-'13	2602-314	
	'09		2602-163
Bearcat 570 XT, Z1 XT	'11-'13	2602-358	
	'09-'10		1602-869
Bearcat Z1 XT GS	'12-'13		1602-869
Crossfire	'09-'11	2602-169	
Crossfire SP	'09-'11	2602-170	
CFR	'09-'11		2602-047
F 800 LXR, F 1100 LXR	'13		2602-575
F 1100 Turbo LXR	'13		2602-576
F 800 SP, F 1100 SP (Inc Turbo)	'13		2602-576
F 800 LXR, F 1100 LXR	'12		2602-019
F 1100 Turbo LXR	'12		2602-046
F 800, F 1100 Sno Pro (Inc Turbo)	'12		2602-046
F Series (Std), LXR	'09-'13		2602-019
F Series SP	'10-'11		2602-046
	'09	2602-255	
Sno Pro 500	'11-'13		2602-019
	'10	2602-255	
Z1 (Std), LXR	'09-'11		2602-019
Z1 Turbo (Std)	'09-'10		2602-019
Z1 Turbo LXR	'10-'11		2602-046
	'09	2602-255	
Z1 Turbo SP	'10-'11		2602-046
	'09	2602-255	
F8 EXT, Z1 Turbo EXT	'10-'11		2602-163
T570, TZ1 Touring	'09-'13		2602-101
TZ1 Turbo Touring	'09-'13		2602-163
XF 800 LXR, XF 1100 LXR (Inc Turbo)	'12-'13	2602-169	
XF 800 SP, XF 1100 SP (Inc Turbo)	'12-'13	2602-170	
XF 800 HC, XF 1100 Turbo HC	'12-'13	2602-166	
XF 800, XF 1100 Crosstour (Inc Turbo)	'13	2602-169	

NOTE: For more information on the Arctic Cat Track Exchange Program, see page 1.

## TRACKS - 2006-PRIOR APPLICATIONS

Tracks listed below will not fit 2007 and newer models with ACT drive and reverse.

### 15" TRACKS (2.52 P)

p/n	Dimensions	Style	Duro	Weight	Clips	Windows
*1602-756	121" x .850"	A	60	34	Every 3rd	Every 3rd Closed
2602-398	121" x 1.00"	Hacksaw NQ	80/70	33	Every 3rd	All Open
*1602-504	121" x 1.00"	B	80/60	34	Every 3rd	Every 3rd Closed
2602-396	121" x 1.25"	Ripsaw NQ	80/70	36	Every 3rd	All Open
2602-397	121" x 1.352"	Cobra NQ (Single-Ply)	80	32	Every Other	All Open
*1602-506	121" x 1.375"	E	80/60	40	Fully Clipped	All Open
2602-004	121" x 1.50"	Ripsaw	80/70	38	Every 3rd	All Open
2602-096	128" x 1.00"	Challenger LP	80		Every 3rd	All Open
2602-147	128.5" x 1.70"		80		Every Other	All Open
2602-100	144" x 1.00"	Challenger LP	80		Every 3rd	All Open
1602-137	144" x 2.00"	Challenger (Notched)	80/60	46	Fully Clipped	All Open
2602-517	156" x 1.00"	Utility	80		Every Other	All Open
1602-336	159" x 2.00"	Challenger (w/o Notch)	80	54	Fully Clipped	All Open

### 15" TRACKS (3.0 P)

1602-607	141" x 1.60"	R	80	40	Every Other	All Open
2602-075	150" x 1.70"	Attack 20 Comp	80		Every Other	All Open

### 13.5" TRACKS (2.52 P)

*1602-502	128" x 1.00"	E	80/60	33	Every 3rd	Every 3rd Closed
*1602-886	128" x 1.00"	Hacksaw	80/60	34	Every 3rd	Every 3rd Closed
*1602-503	128" x 1.375"	E	80/60	39	Fully Clipped	All Open
1602-657	128" x 1.70"		80		Every Other	All Open
1602-750	144" x 1.25"	A	80/60	34	Every 3rd	All Open

### MISC. TRACKS

1602-015	120 (10" x .688")
0602-927	Kitty Cat

- *Cobra 1.352" tracks have a standard lug height of 1.25". The overall lug height including the extended "towers" is 1.352".*
- *60 Durometer is a softer compound and is preferred by deep powder riders.*
- *80 and 90 Durometer is a harder compound to give greater penetration and are preferred hill climb tracks.*
- *80/60, 80/70 Durometer are dual compound tracks with the lug tip 60 or 70 durometer and the remainder 80 durometer.*
- *Tracks w/o Notch fit '03-'04 MC models.*
- *2.25" tracks fit '99-'04 MC models.*
- *Non-Quiet (NQ) Tracks can be used on competitive brands.*

## MAXIMUM LUG HEIGHT

Model	Year	Height
CF	'09-'11	2.25"
	'06-'08	2.00"
F	'12-'13	2.25"
F Series	'07-'11	1.50"
FC (ACT)	'05-'06	1.70"
JR	'07-'08	1.50"
T570, TZ1	'08-'13	1.25"
Z1	'09-'11	1.50"
XF	'12-'13	2.25"
136" Straight Tunnel Models		1.60"

# Wearbars

Page 135

## Ski Applications

	A	B	C	D	E
<b>Standard Wearbars</b>	<b>'05-'13 Saddleless '03-'06 FC, SC '02-'06 ZR</b>	<b>ZR-Style, Parabolic, Deep Snow, Universal Plastic Ski</b>	<b>Blow-Molded Plastic Ski</b>	<b>SLP Powder Pro</b>	<b>C&amp;A Pro ADX</b>
<b>7/16" Diameter Round Host Bar (Pair)</b>	<b>p/n</b>	<b>p/n</b>	<b>p/n</b>	<b>p/n</b>	<b>p/n</b>
Hardweld Wearbar (No Carbide Inserts)	3639-309	0639-198	1639-744		
4" Carbide With Hardweld			1639-527		
6" Carbide With Hardweld			1639-528		
<b>1/2" Diameter Round Host Bar (Pair)</b>					
4" Carbide With Hardweld	3639-310	3639-978		3639-420	
6" Carbide With Hardweld	3639-311	1639-521		3639-421	5639-604
8" Carbide With Hardweld	3639-312	0639-378			5639-605
10" Carbide With Hardweld	3639-313				
<b>5/8" Diameter Round Host Bar (Pair)</b>					
8" Carbide With Hardweld	3639-314				
10" Carbide With Hardweld	3639-315				5639-606
10" Competition Carbide	3639-318				
<b>Shaper Wearbars</b>					
4.5" Carbide (Pair)	4639-949				
6" Carbide (Pair)	4639-950				
7.5" Carbide (Pair)					4639-952
9" Carbide (Pair)	4639-951				4639-953

■NOTE: The accessory Saddleless Ski wearbars listed use a 4-bolt stud pattern. When using accessory wearbars on Saddleless Skis with a 3-bolt stud pattern, it will be necessary to drill another mounting hole in the ski.

<b>Dual Wearbars</b>	<b>'05-'13 Saddleless '03-'06 FC, SC '02-'06 ZR</b>	<b>ZR-Style, Para- bolic, Deep Snow, Universal</b>
<b>Dooly™ Twin Carbide Wearbars (Each)</b>		
Hardweld Wearbar	5639-879	
4" Carbide With Hardweld	3639-343	3639-346
6" Carbide With Hardweld	3639-344	3639-347
8" Carbide With Hardweld	3639-345	3639-348
<b>Deuce™ Twin Carbide Wearbars (Each)</b>		
4.5" Carbide	5639-251	
6" Carbide	5639-252	
9" Carbide	5639-253	
<b>Staggered Wearbars (Each)</b>		
4" Carbide (RH) 3-Bolt (Standard)	2603-988	
4" Carbide (LH) 3-Bolt (Standard)	2603-989	
4" Carbide (RH) 4-Bolt (Aggressive)	2603-930	
4" Carbide (LH) 4-Bolt (Aggressive)	2603-931	
<b>Steel Ski Wearbars</b>	<b>AFS (4-Bolt)</b>	<b>AWS (3-Bolt)</b>
<b>7/16-in. Diameter Round Host Bar (Pair)</b>		
Hardweld Wearbar		1639-784
4-in. Carbide With Hardweld	0638-399	4639-013
6-in. Carbide With Hardweld	0638-520	

## Bulk Pack Wearbars

Our most popular 4", 6", and 8" accessory carbide wearbars are available in bulk packaging, 10 pairs with nuts to a box. These are the same wearbars that we offer in Arctic Cat packaging. Bulk packaging allows Arctic Cat to offer you ultra-competitive pricing on these high volume wearbars.

Description	p/n
<b>Wearbars For Arctic Cat '05-'13 Saddleless Skis; '03-'06 FC, SC; '02-'06 ZR</b>	
10 Pairs 3639-310 - 4" Carbide With Hardweld	2639-184
10 Pairs 3639-311 - 6" Carbide With Hardweld	2639-185
10 Pairs 3639-312 - 8" Carbide With Hardweld	2639-186
<b>Wearbars for ZR Style, Parabolic, and Deep Snow Plastic Skis</b>	
10 Pairs 3639-978 - 4" Carbide With Hardweld	3639-979
10 Pairs 1639-521 - 6" Carbide With Hardweld	2639-189

## Stud Quantity/Inches of Turning Carbide

Sled	Trail	Performance
50-75 HP	48/4 in.	48/6 in.
75-125 HP	102/6 in.	153/8 in.
125-150 HP	153/8 in.	153/10 in.
150-170 HP	153/8 in.	153/10 in.



## STEEL SKI WEARBAR APPLICATIONS

Application	Year	4" Carbide With Hardweld p/n	6" Carbide With Hardweld p/n
AFS	'91 & older	0638-399	0638-520
BC 340	'95-'99	0638-399	0638-520
BC 440	'95-'98	0638-399	0638-520
BC 550	'95-'97	0638-399	0638-520
Cheetah Touring	'86-'91	0638-399	0638-520
	'92-'93	4639-013	
Cheetah	'94	4639-013	
Cougar	'86-'91	0638-399	0638-520
Cougar, Cougar MC	'92-'97	4639-013	
El Tigre	'86-'89	0638-399	0638-520
EXT, EXT MC	'89-'91	0638-399	0638-520
	'92-'97	4639-013	
EXT Special	'91	4639-013	
	'92	0638-399	0638-520
EXT MC	'94-'96	0638-399	0638-520
EXT 580 Z	'93	0638-399	0638-520
EXT 600	'97-'98	4639-013	
Jag, Jag Deluxe	'92-'97	4639-013	
Jag AFS	'89-'91	0638-399	0638-520
Jag AFS LT	'90-'91	0638-399	0638-520
Jag Special	'91	4639-013	
	'92	0638-399	0638-520
Jag Z	'93-'94	0638-399	0638-520
Lynx	'91	0638-399	0638-520
	'92-'93	4639-013	
PTA	'86-'90	0638-399	0638-520
	'91-'96	4639-013	
PA	'90-'91	0638-399	0638-520
	'92-'99	4639-013	
Prowler, Prowler MC	'90	0638-399	0638-520
	'91-'95	4639-013	
Prowler Special	'91	4639-013	
	'92	0638-399	0638-520
Puma, Deluxe, 2-Up	'94-'97	4639-013	
TC	'93-'96	4639-013	
TC MC	'94-'95	4639-013	
WC, WC MC	(AFS) '91-'92	4639-013	
	(AWS) '92-'94	0638-399	0638-520
	'95-'96	4639-013	
Z 440	'95-'96	0638-399	0638-520
ZR 440	'93-'94	0638-399	0638-520
ZR 580, 700 (Steel Ski)	'93-'96	0638-399	0638-520

4 Bolt Wearbar; 0638-399, 0638-520  
3 Bolt Wearbar; 4639-013

## HARDWELD WEARBARS

Application	Year	p/n
4-Stroke Trail	'02	1639-744
4-Stroke Touring	'02	1639-744
	'97-'01	0639-198
BC 340	'00	1639-744
	'95-'99	1639-784
BC 440	'99-'00	0639-198
	'97-'98	1639-784
BC 550	'98-'02	0639-198
Cheetah Touring	'92-'93	1639-784
Cheetah 340, 440, 550	'94	1639-784
Cougar, Cougar 2-Up	'92-'98	1639-784
Cougar Dix	'98	0639-198
EXT	'91-'98	1639-784
EXT Dix	'98	0639-198
EXT Special	'91	1639-784
EXT 600	'97-'98	1639-784
EXT 600 Touring	'98	0639-198
FC	'03	3639-309
Jag	'92-'99	1639-784
Jag AFS L/T	'92-'93	1639-784
Jag Liquid	'96	1639-784
Jag Special	'91	1639-784
Lynx	'92-'93	1639-784
MC	'01-'04	0639-198
PTA 550	'02-'03	1639-744
PTA 660	'02-'03	0639-198
PTA 800	'02	0639-198
PTA	'91-'01	0639-198
	'91-'96	1639-784
PA	'00-'05	1639-744
	'92-'99	1639-784
PE	'97-'98	0639-198
PS	'96-'00	0639-198
Prowler	'91-'95	1639-784
	'90	1639-784
Prowler Special	'91	1639-784
Puma	'94-'97	1639-784
TC	'97-'02	0639-198
	'93-'95	1639-784
WC	'95-'96	1639-784
	'91	1639-784
WC EFI (AFS)	'91-'92	1639-784
Z 370	'99-'05	1639-744
Z 440	'00-'02	1639-744
	'97-'99	0639-198
Z 570	'02-'05	1639-744
ZL	'97-'03	0639-198
ZR	'97-'01	0639-198
ZR 440	'96-'99	0639-198
ZRT	'96-'02	0639-198

# Traction & Control

## 2013 TRACK LUG HEIGHTS AND RECOMMENDED STUD LENGTH

Model	Track Length/ Lugs	Woody's Stud Length	Stud Boy Stud Length	Model	Track Length/ Lugs	Woody's Stud Length	Stud Boy Stud Length
<b>Single-Ply Tracks</b>				<b>2-Ply Tracks</b>			
Bearcat 570	151" x 1.250"	1.325	1.375	F 800, 1100 LXR	128" x 1.000"	1.075	1.080
Bearcat 570 XT, Z1 XT	154" x 1.375"	1.450	1.500	F 1100 Turbo LXR	128" x 1.250"	1.325	1.375
XF 800, 1100 LXR (Inc Turbo)	141" x 1.352**	1.325	1.375	F 800, 1100 SP (Inc Turbo)	128" x 1.250"	1.325	1.375
XF 800, 1100 SP (Inc Turbo)	141" x 1.600"	1.575	N/A	Sno Pro 500	128" x 1.000"	1.075	1.080
				T570, TZ1, TZ1 LXR	144" x 1.000"	1.075	1.080
				TZ1 Turbo LXR	144" x 1.352**	1.325	1.375

\* Cobra 1.352" tracks have a standard lug height of 1.25". The overall lug height including the extended "towers" is 1.352". Because the "towers" will flex, Cobra 1.352" tracks use the same length studs as a 1.25" track.

### CAUTION

- To protect the tunnel from possible damage from the studs, install a Tunnel Protector Kit (see page 55) on models not so equipped. Do not use longer than recommended studs. Use only Arctic Cat approved Stud Templates shown on page 55.
- For Stud Length 1.325" and longer, we recommend the use of a Big Nut or Power Tower Support Nut.
- A short snowflap is required when installing studs on '07-'09 F Series, JR, Z1, and '09 CF (see page 55).
- Do not stud the original 1.250" track on the '06-'08 BC WT Turbo. Damage to the heat exchangers may occur. If you wish to install studs on '06-'08 BC WT Turbo track, the original 1.250" track must be replaced with a 1.00" track.

### Single-Ply Track Application

■NOTE: '09-'13 Track applications shown on page 47.

### ⚠ WARNING

When installing studs on a single-ply track, it is important to use Arctic Cat-approved studs (proper head diameter). If approved studs (proper head diameter) are not used, studs could tear free of the track causing possible injury or even death.

### WOODY'S

A. Page 136

#### GRAND MASTER™ TRACTION KITS

60° Carbide Tip, 5/16" Thread, 1.20" Head.

Application	Qty	p/n
<b>'09 F Series Sno Pro, Z1 Turbo LXR, Z1 Turbo Sno Pro; '10 Sno Pro 500 128" x 1.25"</b>		
Grand Master Stud Kit (1.325" Studs)	102/pk	5639-230
Grand Master Stud Kit (1.325" Studs)	153/pk	5639-231
<b>'12-'13 XF 800 LXR, XF 1100 LXR (Inc Turbo); '09-'11 CF 141" x 1.352"</b>		
Grand Master Stud Kit (1.325" Studs)	94/pk	5639-144
<b>'12-'13 XF 800 Sno Pro, XF 1100 Sno Pro (Inc Turbo) 141" X 1.60**</b>		
Grand Master Stud Kit (1.575" Studs)	94/pk	6639-198
<b>'11-'13 BC XT 154" x 1.375"</b>		
Grand Master (1.450" Studs)	108/pk	5639-626

■NOTE: '12-'13 XF Sno Pro models with 1.60" track require Tunnel Protector kit 6639-118 or 6639-179. The wear strips used in these kits have a taller profile for additional heat exchanger protection.

### GRAND MASTER™ STUDS

60° Carbide Tip, 5/16" Thread, 1.20" Head.

Description	Qty	p/n
1.325" With Big Nut	500/pk	5639-426

### GRAND MASTER™ SUPPORT PLATES

Description	Qty	p/n
Single, Square 1.50" - 5/16"	500/pk	5639-427
Double - 5/16"	51/pk	5639-486

## 2-Ply Track Application



## ARCTIC CAT TRACTION BY

**woody's**

**B**



**C**



Page 136

### TRACTION KITS

Includes Signature Series Studs, Support Plates, Standard or Big Nuts, Template, Drill, and Track Marker.

Application	Qty	p/n
<b>'13 F 800 Sno Pro, F 1100 Sno Pro, F 1100 Turbo LXR, Sno Pro 129" X 1.25" Track 2.86 P</b>		
1.325" Studs	90/Pk	6639-133
1.325" Studs	135/Pk	6639-134
<b>'13 F 800 LXR, F 1100 LXR 129" X 1.00" Track 2.86 P</b>		
1.075" Studs	90/Pk	6639-131
1.075" Studs	135/Pk	6639-132
<b>'12 F 800 Sno Pro, F 1100 Sno Pro, F 1100 Turbo LXR, Sno Pro; '10-'11 F Series Sno Pro, Z1 Turbo LXR, Sno Pro; 128" X 1.25" Track 2.52 P</b>		
1.325" Studs	102/Pk	5639-781
1.325" Studs	153/Pk	5639-782
<b>'12 F 800 LXR, F 1100 LXR; '07-'13 F Series; '09-'11 CFR, Z1, Z1 Turbo; '11-'13 Sno Pro 500 128" X 1.00" Track 2.52 P</b>		
1.075" Studs	102/Pk	4639-550
1.075" Studs	153/Pk	4639-551
<b>'06-'08 CF 136" X 1.25" Track 2.52 P</b>		
1.325" Studs	108/Pk	4639-340
1.325" Studs	162/Pk	4639-341
<b>'11-'12 Sno Pro 600 SX 129" x 1.70" Track 2.86 P</b>		
1.860" Studs	90/Pk	5639-637

**B. Page 136**

### SIGNATURE SERIES STAINLESS STEEL

60° Carbide Tip, 5/16" Threads, 15/16" Head. Support Plates sold separately.

Description	Qty	p/n
1.075 Stud With Nyloc Nut	90/Pk	6639-119
	102/Pk	3639-915
	135/Pk	6639-120
	153/Pk	4639-739
	1000/Pk	3639-917
1.175 Stud With Nyloc Nut	90/Pk	6639-121
	102/Pk	3639-919
	135/Pk	6639-122
	153/Pk	4639-740
	1000/Pk	3639-921
1.325 Stud With Big Nut	90/Pk	6639-123
	102/Pk	3639-923
	135/Pk	6639-124
	153/Pk	4639-741
	1000/Pk	3639-925
1.450 Stud With Big Nut	102/Pk	3639-927
	153/Pk	4639-742
	1000/Pk	3639-929

**C. Page 137**

### GOLD DIGGER® TRACTION MASTER®

60° Carbide Tip, 5/16" Threads, 1" Head. Support Plates sold separately.

Description	Qty	p/n
1.075 Stud With Nyloc Nut	90/Pk	6639-125
	102/Pk	3639-067
	135/Pk	6639-126
	153/Pk	4639-748
	1000/Pk	1639-118
1.175 Stud With Nyloc Nut	90/Pk	6639-127
	102/Pk	3639-069
	135/Pk	6639-128
	153/Pk	4639-749
	1000/Pk	1639-958
1.325 Stud With Big Nut	90/Pk	6639-129
	102/Pk	3639-362
	135/Pk	6639-130
	153/Pk	4639-750
	1000/Pk	1639-519
1.450 Stud With Big Nut	102/Pk	5639-913
	135/Pk	5639-914
	1000/Pk	5639-915





Page 137

## BIG NUT

These aluminum nuts provide extra strength and are recommended when using studs 1.325" and longer.

Description	Qty	p/n
Short - 1.325" Studs	90/Pk	6639-160
	102/Pk	4639-736
	135/Pk	6639-161
	153/Pk	4639-737
	1000/Pk	4639-738
Tall - 1.450" Studs	90/Pk	6639-162
	102/Pk	4639-794
	135/Pk	6639-163
	153/Pk	4639-795
	1000/Pk	4639-796



Page 137

## DOUBLE DIGGER™ SUPPORT PLATES

Description	Qty	p/n
5/16"	12/Pk	2639-134
	48/Pk	2639-135

### Woody's Limited Warranty

International Engineering & Manufacturing, Inc. warrants each product manufactured by it to be free from defects in material and workmanship under use for the purpose for which it is intended. The Company shall not be liable for damage or delays caused by defective materials or workmanship; is limited to the repair or replacement at its factory of defective article or part thereof, which may be returned to the factory, transportation charges, prepaid within one (1) year after delivery to the original purchaser. Proof of purchase is also required. The Company shall be the sole judge of the existence of any defect in the article so returned. No claims for charges incurred in the removal, disassembly or reinstallation of such article shall be allowed. Product manufactured for consumer use on snowmobiles is designed for snow or ice only, use on any other surface voids warranty.

This Warranty shall not cover any article which has been misused or neglected or damaged by accident or any article which has been altered outside the Company's factory. The Warranty for studs is void unless the studs are installed with Woody's installation tools, support plates and lock nuts; according to the recommendations set forth in Woody's Instructions and Template Patterns. This Warranty does not cover bending, chipping, flaking or carbide pin breakage or pin loss from stud wear, stud replacement labor or shipping.

The Company shall, in no event be liable for consequential damage or contingent liability arising out of any total or partial failure to function of any article manufactured by it or of any equipment on or in which it is used. Failure of a user to give notice to claim as to defect claimed under the provisions of the Warranty within one (1) year after delivery to original use, such claim shall constitute a waiver by consumer of all claims with respect to goods and equipment.

No express, implied, or statutory warranty other than that herein set forth is made or authorized to be made by the Company. All returned warranties will not be accepted without a return authorization number.

Woody's® Team Woody's®, Snowmobiler Logo, Traction Master, Flat-Top, Gold Digger, Mega-Bite, Excel, Chisel Tooth, Square Digger, Round Digger, Double Digger, Road Flinner, Star Stud, Top-Stock, Extender Trail III, Trail Blazer IV, Executive, and Ultra Series are trademarks and/or trade names of International Engineering and Manufacturing, Inc. Traction Master refers to a patented product of International Engineering & Manufacturing, Inc. and is covered by US Patent No. 5,23,266 and Canadian Patent No. 2,086,186. Woody's® Mega-Bite studs are covered by US Patent No. D415, 954 and Canadian Patent No. 88,613. Woody's® Universal Template is Patent Pending.

Woody's® Manufacturer Warranty Returns  
Call our customer service department for a Return Authorization Number. This number must be visible on the outside of the box. The product must be inspected by a Woody's technician to determine if the product is defective due to material, quality or workmanship before a final warranty determination is made. Proof of purchase is required. All returns to the manufacturer are for exchange only.



Page 137

## A. BIGGER SUPPORT PLATES

Description	Qty	p/n
1.250-in. - Square	90/Pk	6639-164
	102/Pk	3639-093
	135/Pk	6639-165
	153/Pk	4639-752
	1000/Pk	0639-907
1.375-in. - Round	90/Pk	6639-166
	102/Pk	3639-091
	135/Pk	6639-167
	153/Pk	4639-751
	1000/Pk	3639-005

## B. BIGGER COLORED SUPPORT PLATES

Description	Color	Qty	p/n
1.250-in. Square	Black	90/Pk	6639-168
		102/Pk	4639-257
		135/Pk	6639-169
		153/Pk	4639-753
		1000/Pk	4639-259
1.250-in. Square	Green	90/Pk	6639-170
		102/Pk	3639-388
		135/Pk	6639-171
		153/Pk	4639-754
		1000/Pk	2639-857
1.250-in. Square	Orange	90/Pk	6639-172
		102/Pk	3639-390
		135/Pk	6639-173
		153/Pk	4639-755
		1000/Pk	2639-861

## ARCTIC CAT TRACTION BY



### Stud Boy Limited Warranty

Liberty Products, Inc. warrants each product manufactured by it to be free of defects in workmanship and material while used for the purpose for which it is designed. Liberty Products, Inc. shall not be liable for damages or delays as a result of defects caused by defective workmanship or materials. Warranty is limited to the repair or replacement at Liberty Products of any defective part or product, within one (1) year of the delivery to the original purchaser, proof of purchase must accompany the product returned (freight prepaid). Liberty Products, Inc. shall be the sole judge of any defect, which might be claimed on the returned product. No other charges may be claimed in conjunction with the removal, reinstallation of such product. These products are designed and manufactured for use on snowmobiles on snow and ice only, use on other surfaces voids warranty. Warranty will be void if product has been misused, neglected, damaged or modified outside of Liberty Products, Inc. Does not cover bending, chipping, flaking or carbide breakage or loss from wear. Liberty Products, Inc. will not be liable for consequential damage or contingent liability arising from any total or partial failure to function of any product manufactured by it or any equipment on or in which it is used. No further warranty of any type is intended or implied or will be authorized to be made by Liberty Products, Inc.

## 2-Ply Track Application

Page 137

### POWER POINT™ TRACTION KITS

Application	Qty	p/n
<b>'13 F 800 Sno Pro, F 1100 Sno Pro, F 1100 Turbo LXR, Sno Pro 129" X 1.25" Track 2.86 P</b>		
1.375" Studs	90/Pk	6639-141
1.375" Studs	135/Pk	6639-142
<b>'13 F 800 LXR, F 1100 LXR 129" X 1.00" Track 2.86 P</b>		
1.080" Studs	90/Pk	6639-139
1.080" Studs	135/Pk	6639-140
<b>'12 F 800 Sno Pro, F 1100 Sno Pro, F 1100 Turbo LXR, Sno Pro; '10-'11 F Series Sno Pro, Z1 Turbo LXR, Sno Pro; 128" X 1.25" Track 2.52 P</b>		
1.375" Studs	102/Pk	5639-783
1.375" Studs	153/Pk	5639-784
<b>'12 F 800 LXR, F 1100 LXR; '07-'13 F Series; '09-'11 CFR, Z1, Z1 Turbo; '11-'13 Sno Pro 500 128" X 1.00" Track 2.52 P</b>		
1.080" Studs	102/Pk	5639-099
1.080" Studs	153/Pk	5639-100
<b>'08-'13 T570, TZ1, TZ1 LXR 144" X 1.00" Track 2.52 P</b>		
1.080" Studs	114/Pk	5639-146
<b>'11-'12 SP 600 SX</b>		
1.875" Studs	90/Pk	5639-636



Page 137

### POWER POINT™

60° Carbide Tip, 5/16" Thread, 1" Head. Support Plates sold separately.

Description	Qty	p/n
1.080 With Nyloc Nut	90/Pk	6639-135
	102/Pk	5639-072
	135/Pk	6639-136
	153/Pk	5639-073
1.375 With Nyloc Nut	90/Pk	6639-137
	102/Pk	5639-078
	135/Pk	6639-138
	153/Pk	5639-079
1.500 With Nyloc Nut	102/Pk	5639-081
	153/Pk	5639-082



Page 137

### POWER PLATE™ BACKERS

Description	Qty	p/n
1.270-in.	90/Pk	6639-174
	102/Pk	5639-093
	135/Pk	6639-175
	153/Pk	5639-094
	1000/Pk	5639-095

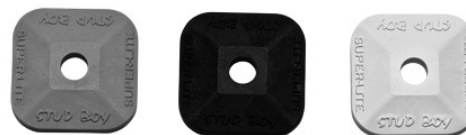

Page 138

### SUPER-LITE PLUS BACKERS

Single-Ply and 2-Ply application

Description	Color	Qty	p/n	
1.450" x 5/16"	Black	102/Pk	5639-362	
		153/Pk	5639-363	
		1000/Pk	5639-364	
	Green	102/Pk	5639-366	
		153/Pk	5639-367	
		1000/Pk	5639-368	
	Orange	102/Pk	5639-370	
		153/Pk	5639-371	
	White	1000/Pk	5639-372	
		102/Pk	5639-443	
			153/Pk	5639-444



Page 138

### POWER TOWER SUPPORT NUTS

Recommended when using studs 1.375" and longer.

Description	Qty	p/n
.750"	90/Pk	6639-176
	102/Pk	5639-096
	135/Pk	6639-177
	153/Pk	5639-097
	1000/Pk	5639-098



# General Maintenance



Page 139

## SLED LIFT

Maximum lift capacity 625 lbs.

### Description

- (A) Sled Lift (Ship wt. 65 lb)
- (B) Wheel Kit (Ship wt. 15 lb)

**p/n**  
4639-992  
4639-993  
5639-926



Page 139

## JACK STAND

**Description**  
33" High

**p/n**  
4639-768

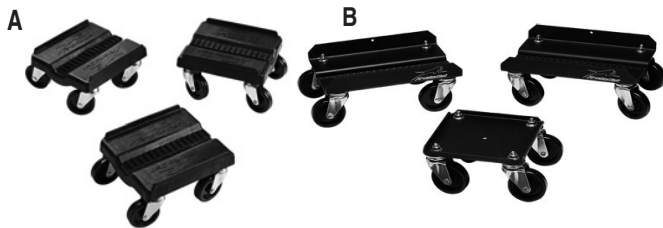

Page 139

## CAT CADDY

Set of 3.

### Description

- (A) Plastic - Black
- (A) Plastic - Green
- Replacement Wheel - Push-in (Each)
- (B) Aluminum - Black
- Replacement Wheel - Threaded (Each)

**p/n**  
5639-873  
5639-874  
0641-264  
4639-766  
0641-535



Page 140

## FRONT END LIFT

**Description**  
Front End Lift

**p/n**  
5639-151



Page 139

## SLED SLIDES

Set of 3.

### Description

Steel - Green

**p/n**  
5639-579

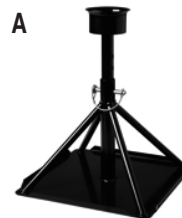

Page 140

## HANDLEBAR STAND

**Description**  
(A) Handlebar Stand  
(B) Steering Post Stand

**p/n**  
5639-152  
5639-946



Page 140

## SHOP DOLLY

Added freight charges may apply.

Description	p/n
Shop Dolly	5639-373
(Shipping: 46L x 25W x 11H, 70 lb)	
Replacement Strap	5639-446
Replacement Wheel (Each)	5639-514



Page 141

### A. STANDARD TIE-DOWNS

1" x 69", 1,000-lb Rating

Sold in pairs.

Description	p/n
Black	5639-411
Green	5639-415

### B. DELUXE TIE-DOWNS

1.125" x 78", 1,200-lb Rating

Sold in pairs.

Description	p/n
Black	5639-423

### C. RATCHET TIE-DOWNS

1.125" x 102" 1,200-lb Rating. Sold in pairs.

Description	p/n
Black	5639-424

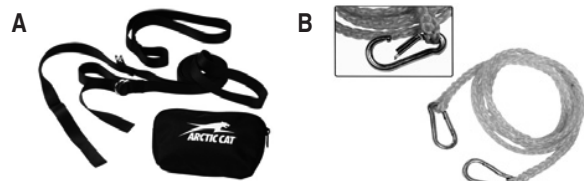

Page 141

### A. TOW STRAP

Description	p/n
Tow Strap	4639-247

### B. TOW ROPE

Description	p/n
Tow Rope	0636-577



Page 141

## HEATED SHIELD ADAPTER

Application	p/n
Models with accessory outlet	5639-645



Page 141

## TOOL BAG

Description	p/n
Tool Bag	5639-834



Page 141

## RACING TAPE

2" x 60-yd. rolls.

Description	p/n
Black	4639-579
Green	4639-580
Orange	5639-103



## TOUCH-UP PAINT

Description	Application	1/2 oz.	12 oz.
<b>Hood Paint</b>			
Black (Gloss)	Black Hoods	0652-100	0652-022
Black (Flat)	'13 F, M, XF, TZ1, TZ1 Turbo, BC Z1 XT LTD	0652-187	0652-188
Apple Green Metallic	'10 F Series LE, TZ1 Turbo LE, Z1 Turbo LE	0652-152	0652-153
Cat Green	'00-'04 ZR; '01-'04 Z; '03-'04 FC; '04 MC	0652-099	0652-067
Copper	'09 F Series LE, TZ1 Turbo LE, Z1 Turbo LE	0652-139	0652-140
Desert Red Metallic	'11-'12 TZ1 LXR, TZ1 Turbo LXR, BC Z1 XT LTD	0652-160	0652-161
Navy Blue	'10 TZ1 LXR, TZ1 Turbo LXR	0652-154	0652-155
Orange * (Top Coat)	'04-'06 KC; '05-'06 FC; '06-'07 Z; '05-'08 M; '06-'08 CF; '07-'08 F Series; '11 CF SP	0652-105	0652-106
Pearl Cat Green	'05-'06 FC, SC, Z, ZR; '05-'07 M; '06-'07 CF; '09-'11 M8 HCR	0652-115	0652-117
Pearl White (Top Coat)***	'12 F, M, XF LTD	0652-175	0652-176
Pearl White (Base Coat)	'12 F, M, XF LTD	0652-181	0652-182
Sublime Green**	'11 M8 LTD, CF LTD, F8 LTD, Z1 Turbo LTD	0652-164	0652-165
White Metallic * (Top Coat)	'08-'11 M Series SP; '11 CFR, TZ1 LXR, TZ1 Turbo LXR	0652-133	0652-134
Gold Metallic (Top Coat)		0652-173	0652-174
White (Base Coat)		0652-119	0652-120
Clear (Top Coat) (12-oz. Overspray Leveler)		0652-109	0652-166

\* Metallic Top Coat only. You must first apply White (Base Coat) before applying color.

\*\* Sublime Green (Base Coat) requires the use of Gold Metallic Top Coat.

\*\*\* Metallic Top Coat only. You must first apply Pearl White (Base Coat) before applying color.

Metal Paint		1/2 oz.	12 oz.
Black	Metal Parts	0652-110	0652-024
Cat Green	'98-'11	0652-111	0652-077
Orange	'08-'13	0652-141	0652-142
Orange Metallic (Top Coat)****	'12 F, M, XF LTD	0652-183	0652-184
Orange Metallic (Base Coat)	'12 F, M, XF LTD	0652-179	0652-180
Pearl Cat Green	'08-'13	0652-144	0652-145
Pearl White (Top Coat)***	'12 F, M, XF LTD	0652-177	0652-178
Pearl White (Base Coat)	'12 F, M, XF LTD	0652-181	0652-182
Platinum	'02-'11	0652-112	0652-096
White	'13 F, M, XF LTD	0652-189	0652-190
Black	High Temp		0652-052

\*\*\* Metallic Top Coat only. You must first apply Pearl White (Base Coat) before applying color.

\*\*\*\* Metallic Top Coat only. You must first apply Orange Metallic (Base Coat) before applying color.

■NOTE: Models not listed have non-paintable, color-molded plastic.



# Oil & Care

■ NOTE: Visit [www.arcticcatlubricants.com](http://www.arcticcatlubricants.com) for more oil information.

## 2013 MODEL YEAR SNOWMOBILE OIL APPLICATION CHART

Model	0W-40	APV	Formula SS	Formula 50	Capacity
120	X				20.3 U.S. oz
Sno Pro 500		X	X	X	2.75 U.S. Qt
Bearcat 570/ F570/T570				X	4.2 U.S. Qt
Bearcat 570 XT				X	4.8 U.S. Qt
F 800/M 800/XF 800 Models		X	X		3.9 U.S. Qt
F 1100/M 1100/ XF 1100 Models	X				3.28 U.S. Qt
Bearcat Z1/TZ1 Models	X				4.0 U.S. Qt



Page 142

### APV SYNTHETIC OIL

Our APV Synthetic Oil stands alone as the best, most performance oriented lubrication that could possibly be put through your sled. The best oil for the dollar guarantees flawless engine operation.

Description	p/n
Quart	4639-349
Gallon	5639-469
2.5 Gallon	4639-347
16 Gallon Drum	2639-510
16 Gallon Drum (50th Anniversary)	5639-908
55 Gallon Drum	2639-509



Page 142

### FORMULA SS SEMI-SYNTHETIC OIL

Formula SS Semi-Synthetic 2-cycle oil offers the benefits of a semi-synthetic formulation at a phenomenal value. Use in ALL Arctic Cat 2-cycle engines, including Arctic Power Valve engines.

Description	p/n
Quart	5639-470
Gallon	5639-471
2.5 Gallon	5639-472
16 Gallon Drum	5639-473
16 Gallon Drum (50th Anniversary)	5639-909
55 Gallon Drum	5639-474



Page 142

### FORMULA 50 OIL

Mineral based 50:1 Injection Oil. High quality mineral base formulation, proven performance over time. Provides rust and corrosion protection. Mixes easily with fuel and all other Arctic Cat 2-cycle engine oils.

Description	p/n
Quart	5639-475
Gallon	5639-476
2.5 Gallon	5639-477
16 Gallon Drum	5639-478
16 Gallon Drum (50th Anniversary)	5639-910
55 Gallon Drum	5639-479



Page 143

### SYNTHETIC 0W-40 OIL

Unique synthetic formulation designed and tested for use in Arctic Cat 4-Cycle Snowmobiles. Premium additive system provides superior cleanliness, anti-wear protection, and minimizes deposit formations.

Description	p/n
Quart	5639-172
Gallon	5639-173
16 Gallon Drum	5639-912
16 Gallon Drum (50th Anniversary)	5639-911
55 Gallon Drum	5639-175



Page 143

### SYNTHETIC OIL CHANGE KIT

Application	p/n
'07-'12 1100 cc Models (Includes Turbo)	5639-174



## EMPTY DRUM

**Application**  
16 Gallon (50th Anniversary)

**p/n**  
5639-907



## SYNTHETIC CHAIN LUBE

**Description**  
8 oz.  
12 oz.  
2.5 gallon

**p/n**  
5639-038  
5639-039  
6639-117



## ARCTIC CAT CHAIN LUBE

**Description**  
8 oz.  
12 oz.  
2.5 Gallon

**p/n**  
4639-363  
4639-364  
1639-247



Page 144

## SYNTHETIC ACT GEARCASE FLUID

**Description**  
3 oz. ACT Non-Reverse  
12 oz. ACT w/Reverse  
15 oz. ACER (Engine) Reverse  
Gallon

**p/n**  
4639-361  
4639-628  
5639-219  
5639-632

■NOTE: ACT Drive Gasket Sets (See pg. 68)



Page 144

## ACT FLUSH FLUID

**Description**  
6 oz.  
Gallon

**p/n**  
4639-333  
5639-847



Page 144

## SYNTHETIC SHOCK OIL

**Description**  
Lt Wt - Quart  
Med/Lt Wt - Quart  
Med Wt - Quart

**p/n**  
4639-367  
4639-369  
4639-368



Page 144

## SEMI-SYNTHETIC SHOCK OIL

**Description**  
Quart

**p/n**  
5639-530



Page 144

## ARCTIC CAT SHOCK OIL

**Description**  
Quart

**p/n**  
4639-366



Page 145

## ARCTIC CAT ANTIFREEZE

Description  
Gallon

p/n  
0436-909



Page 145

## FUEL INJECTOR & CARBURETOR CLEANER

Description  
12 oz.

p/n  
0436-904



Page 145

## FUEL DE-ICER

Description  
12 oz.

p/n  
0436-906



Page 145

## ENGINE PRESERVER

Description  
12 oz.

p/n  
0436-888



Page 145

## FUEL STABILIZER

Description  
8 oz.

p/n  
0436-907



## FOX FLOAT FLUID

Specially made for use in the air chamber of FOX FLOAT Air Shox.

Description  
8 oz.

p/n  
4639-012



Page 145

## DOT 4 BRAKE FLUID

Description  
12 oz.

p/n  
5639-848



Page 145

### ARCTIC CAT ALL-TEMP GREASE

Description  
14 oz.

p/n  
4639-365

### MISCELLANEOUS GREASE

Description  
Throttle Cable Lube .5 oz.  
Electric Start 2 cc  
High Temperature .5 oz.  
Dielectric 2.7 oz.

p/n  
1056-053  
1056-272  
1056-077  
1056-287



Page 145

### CAT CLEANER

Description  
22 oz.

p/n  
4639-371



Page 145

### HOOD & WINDSHIELD CLEANER/POLISH

Description  
8 oz.

p/n  
4639-559



### CHAIN LUBRICANT

Description  
12 oz.

p/n  
0436-903



### HIGH OCTANE RACE FUEL

Description

110 Octane Race Fuel  
16 Gallon Drum  
55 Gallon Drum

p/n  
2639-098  
2639-097

116 Octane Race Fuel  
16 Gallon Drum  
55 Gallon Drum

p/n  
3639-620  
3639-621

### DRUM PUMP (NOT SHOWN)

Application

16 to 55 Gallon Drums

p/n  
1639-249



### VEHICLE WASH/CLEANER

Description  
Gallon  
5 Gallon  
30 Gallon

p/n  
4639-631  
4639-630  
4639-629

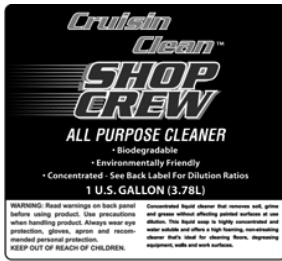

**ALL PURPOSE CLEANER**

<b>Description</b>	<b>p/n</b>
Gallon	4639-634
5 Gallon	4639-633
30 Gallon	4639-632



**LEATHER WATER REPELLENT**

<b>Description</b>	<b>p/n</b>
Leather Water Repellent	4912-052



**HEAVY DUTY CLEANER/DEGREASER**

<b>Description</b>	<b>p/n</b>
Gallon	4639-637
5 Gallon	4639-636
30 Gallon	4639-635



**REVIVEX WATER & STAIN REPELLENT**

<b>Description</b>	<b>p/n</b>
Revivex Water & Stain Repellent	4201-280

**CLEANING KIT**

Kit includes two gallons each of the following cleaners:  
 Vehicle Wash/Cleaner, All Purpose Cleaner, Heavy Duty Cleaner/Degreaser.

<b>Description</b>	<b>p/n</b>
Cleaning Kit	4639-666



**WATER/STAIN REPELLENT**

<b>Description</b>	<b>p/n</b>
Water/Stain Repellent	4912-152



**LEATHER CLEANER/CONDITIONER**

<b>Description</b>	<b>p/n</b>
Leather Cleaner/Conditioner	4912-051

## Misc Accessories



Page 146

### CTEK BATTERY MAINTAINER

**Description**

12V 800 mA (Includes leads A, B, & D on this page)

**p/n**

5639-418



Page 146

### CTEK BATTERY CHARGER/MAINTAINER

**Description**

12V 3.3 amp (Includes leads A, B, & D on this page)

**p/n**

5639-419

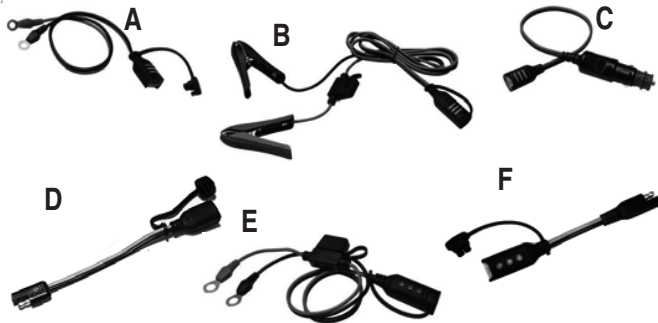

Page 146

### CTEK BATTERY LEADS

■NOTE: Comfort Indicators feature a three LED battery condition indicator.

**Description**

(A) Ring Terminals  
 (B) Alligator Clips  
 (C) Outlet  
 (D) Style 21 Adapter  
 (E) Comfort Indicator - Ring Terminals  
 (F) Comfort Indicator - Style 21

**p/n**

5639-420  
 5639-421  
 5639-422  
 5639-484  
 5639-485  
 5639-397



### YUASA BATTERY MAINTAINER

**Description**

12V 900 mA

**p/n**

4639-998

A



B

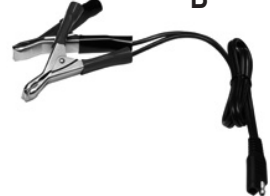

### YUASA BATTERY LEADS

**Description**

(A) Ring Terminals  
 (B) Alligator Clips

**p/n**

5639-162  
 5639-163



### ACCESSORY ADAPTER

**Description**

2-Outlet  
 3-Outlet

**p/n**

1639-623  
 1639-624

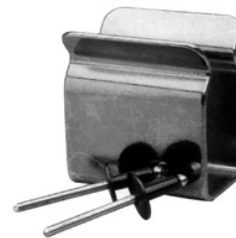

### DRIVE BELT HOLDER

**Description**

Drive Belt Holder

**p/n**

0636-659



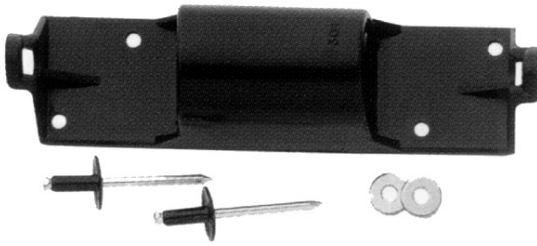

## SPARK PLUG HOLDER

**Description**  
Plug Holder

**p/n**  
4639-549



## SPARK PLUG CADDY

**Description**  
Green

**p/n**  
1639-618



## TEMPERATURE GAUGE

**Application**  
'99-'07 LC Models Except CF, F, FC, JR, M, SC, 4-Stroke

**p/n**  
1639-217

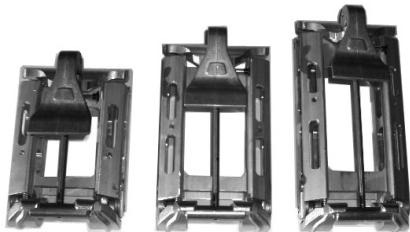

## HANDLEBAR RISER KIT

Fits '07-'11 F Series Sno Pro; '09-'11 CFR, Z1

**Description**  
4"  
5"  
6"

**p/n**  
4639-599  
4639-600  
4639-601

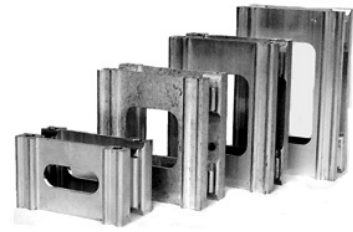

## HANDLEBAR RISERS

Fits '02-'06 ZR; '03-'06 FC; '07-'11 F Series (Std)

**Description**  
2.44"  
3.00"  
4.44"  
5.44"  
6.44"

**p/n**  
0605-514  
0605-884  
0605-513  
0605-491  
0605-512

■NOTE: If 6.44" Riser Block (p/n 0605-512) is used on an '05-'06 FC with ACT Drive, it is necessary to install a longer Brake Line (p/n 1602-588).



## RAIL BRACE KIT

Includes RH & LH rail braces and mounting hardware.

**Application**  
'12-'13 M 153" & 162", XF 141"  
  
'12-'13 M HCR 153"  
'12-'13 M HCR 162"  
'09-'11 M Series 153"

**Color**      **p/n**  
Black            5639-981  
Orange         5639-982  
Unpainted      5639-983  
Unpainted      5639-997  
Unpainted      6639-086  
Unpainted      5639-242

## SPEEDOMETER/TACHOMETER

**Application**  
'12 Sno Pro 600  
'08-'11 Sno Pro 600

**p/n**  
5639-993  
4639-960



## HEAVY-DUTY HANDLEBAR

Includes grips and heating elements.

**Application**  
**Heavy-Duty .095 Wall (14 ga)**  
'05-'12 Sno Pro  
  
**Standard .083 Wall (13 ga)**  
'05-'12 Sno Pro

**Color**      **p/n**  
Black         1705-451  
Green         1705-155  
  
Black         1705-450  
Green         1705-042

## THROTTLE LIMITER KIT, 50%

Application	p/n
'10-'13 Sno Pro 500	0709-088
'08-'12 Sno Pro 600	1705-359

## ALUMINUM THROTTLE BLOCK

Application	p/n
'10-'13 Sno Pro 500	0709-084



## THROTTLE LEVER BOLT KIT

Fits models with aluminum throttle block.

Application	p/n
'05-'10 Sno Pro 600	4639-336



## WHEEL KITS

Application	p/n
'12-'13 F 800, F 1100, F 1100 Turbo (Two 5.63" Wheels w/Mounts)	6639-184
'12-'13 F 800, F 1100, F 1100 Turbo (Four 5.35" Wheels w/o Mounts)	6639-196
'13 F 800, F 1100, F 1100 Turbo (Eight 5.35" Wheels, four Mounts)	6639-185
'12 Sno Pro 600 (Four 5.63" Wheels w/Mounts)	5639-995
'08-'11 Sno Pro 600 SX (Four 5.63" Wheels w/Mounts)	4639-964



## SWAY BAR KITS

■ NOTE: '11-'13 Sno Pro 500 and '12 Sno Pro 600 require a Sway Bar Mounting Kit.

Application	p/n
'09-'13 BC 570 XT; '10-'13 BC Z1 XT	5639-441
'09-'13 BC 570	5639-200
'99-'07 PA, Z; '06-'08 BC	4639-322
'10-'13 Sno Pro 500	11.7 mm 4639-961 12.7 mm 4639-962 14.3 mm 4639-963
'12 Sno Pro 600	11.1 mm 5639-998 12.7 mm 5639-999

## SWAY BAR MOUNTING KIT

Application	p/n
'10-'13 Sno Pro 500	5639-635
'12 Sno Pro 600	6639-001

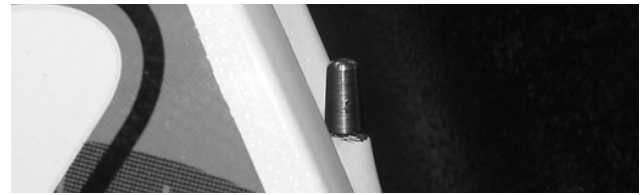

## HOOD LATCH REPAIR KIT

Includes two pins.

Application	p/n
'05-'11 CF, CFR, M Series	5639-498

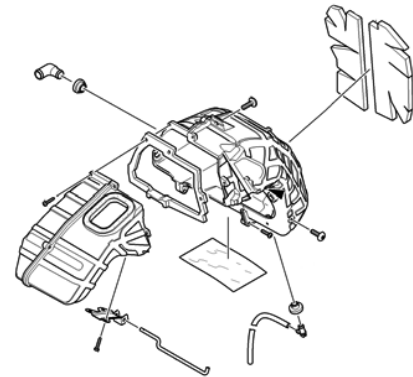

## SPLIT AIRBOX KIT

Two-piece design provides easier access to engine components.

Application	p/n
'07-'08 JR; '08-'11 TZ1; '09-'11 BC Z1 XT, Z1	5639-934



## SPARK PLUG CAPS

Description	p/n
(A) Silicone Rubber - Black	3006-367
(B) Standard Type - Black	3003-175



## NGK® SPARK PLUGS

Arctic Cat ATV and Snowmobile applications in **BOLD**.

### Iridium Spark Plugs

Description	p/n	Description	p/n
BR8EIX	<b>0217-735</b>	CR7EIX	<b>0217-734</b>
BR9EIX	<b>0217-729</b>	DR7EIX	<b>0217-736</b>
BR10EIX	0217-804	MR8AI-9	<b>0217-806</b>
CR6EIA-9	0217-733		

### Standard Spark Plugs

Description	p/n	Description	p/n
AB7	0217-728	BR9ECS-5	0217-786
AB8	0217-808	BR9ES (SCREW CAPS)	<b>0217-035</b>
B2LM	0217-778	BR9ES (SOLID CAPS)	<b>0217-700</b>
B4LM	0217-770	BR9EYA	<b>0217-709</b>
B6L	0217-789	BR9HS-10	0217-756
B6S	0217-765	BR10ES (SOLID CAPS)	<b>0217-634</b>
B7HS	0217-044	BR10EYA	<b>0217-714</b>
B8ES	0217-029	BU8H	0217-744
B8HS	0217-043	BUHW	0217-751
B9ES	0217-015	BUHW-2	0217-750
B9HS-10	0217-791	CMR7A	0217-776
BKR6EKU	0217-793	CPR8E	0217-799
BM7A	0217-781	CR6E	<b>0217-632</b>
BMR4A	0217-767	CR6HS	0217-792
BMR6A	0217-753	CR6HSA	<b>0217-725</b>
BP4HS	0217-761	CR7E	<b>0217-708</b>
BP5HS	0217-783	CR7HS	0217-788
BP8H-N-10	0217-746	CR7HSA	<b>0217-726</b>
BPM6A	0217-763	CR8E	<b>0217-705</b>
BPM7A	0217-749	CR8EK	<b>0217-711</b>
BPM7Y	0217-764	CR9E	0217-738
BPM8Y	0217-752	CR9EH-9	0217-766
BPMR4A	0217-772	CR9EK	0217-755
BPMR6A	0217-773	CR10EK	0217-787
BPMR7A	0217-741	D7EA	0217-795
BPR2ES	0217-747	D8EA	0217-796
BPR4ES	<b>0217-809</b>	D8HA	0217-794
BPR4HS	0217-785	D9EA	0217-784
BPR5ES	0217-704	DCPR6E	0217-779
BPR5HS	0217-702	DCPR7E	<b>0217-717</b>
BPR6ES	<b>0217-807</b>	DCPR8E	0217-774
BPR6EFS	0217-748	DP8EA-9	0217-782
BPR6HS	0217-777	DPR6EA-9	0217-754
BPR7HS	<b>0217-716</b>	DPR7EA-9	<b>0217-730</b>
BPR9ES	0217-762	DPR8EA-9	0217-737
BPZ8H-N-10	0217-769	DPR8Z	0217-775
BPZ8HS-10	0217-757	DPR9EA-9	0217-790
BR6FS	0217-742	DR7EA	<b>0217-713</b>
BR6HS	0217-027	DR8EA	3304-919
BR7ES	0217-745	DR8ES	0217-771
BR7HS	0217-768	DR8ES-L	0217-740
BR7HS-10	0217-758	IZFR5G	0217-759
BR8ES (SCREW CAPS)	0217-034	KR8AI	<b>0217-719</b>
BR8ES (SOLID CAPS)	<b>0217-701</b>	LFR5A-11	0217-760
BR8HS	0217-739	LFR6A-11	0217-780
BR8HS-10	0217-743	PZFR6H	0217-641



## FUEL PUMP REPAIR KITS

Description	p/n
Rectangular Mikuni	0636-272
Round Mikuni	0636-276
Square Mikuni	0636-640
Pentagon Mikuni	1639-191
ATP 2/3	2639-095

## SILICONE GASKET MAKER

Excellent for sealing around belly pan area and air box seams.

Description	p/n
Ultra Black Silicone Gasket Maker 70 ml	1639-834

## HIGH TEMP SILICONE SEALANT

This sealant is recommended for sealing exhaust flanges, gaskets and crankcase halves of all Arctic Cat liquid-cooled engines.

Description	p/n
High Temperature Silicone 90 ml	0636-069

## LOCTITE

Description	p/n
Loctite 242 Blue 10 ml	1639-814
Loctite 242 Blue 50 ml	1639-815
Loctite 263 Red 10 ml	5639-901
Loctite 263 Red 50 ml	5639-902
Loctite 271 Red 10 ml	1639-819
Loctite 271 Red 50 ml	1639-820
Loctite 290 Green Wicking 10 ml	1639-823
Loctite 290 Green Wicking 50 ml	1639-824
Loctite 609 Green Retaining 50 ml	1639-821
Loctite 620 Green Ret Hi Temp 10 ml	1639-826
Loctite 620 Green Ret Hi Temp 50 ml	1639-822

## HANDLEBAR GRIP ADHESIVE

Description	p/n
Loctite 498 1 oz.	1048-058
Grip-It Glue 1 oz.	0441-510

## CRANKCASE SEALANT

This sealant is recommended for sealing all Arctic Cat fan-cooled engine crankcase halves.

Description	p/n
Three-Bond Gasket Sealant	0636-070

## CRANKCASE SEALANT

This sealant is recommended for Arctic Cat 2-Stroke liquid-cooled and 4-Stroke engines.

Description	p/n
Sealant, 100 gram tube	1048-070

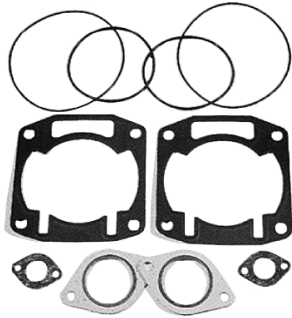

## GASKET SETS

### Application

340 F/C Twin  
 370 F/C Twin  
 440 F/C Twin (Except those listed below)  
 440 F/C Twin ('99 Z 440; '00-'03 Z 440 Sno Pro)  
 440 F/C Twin  
 440 L/C Twin

440 L/C Twin (ZR)  
 440 L/C Twin (Prowler Special)  
 440 L/C Twin w/Reed  
 500 F/C Twin (56 H.P.)  
 500 F/C Twin (48 H.P.)  
 500 L/C Twin, Non-APV "Laydown" (Sno Pro)  
 500 L/C Twin, APV "Laydown"  
 500 L/C Twin, APV  
 500 L/C Twin, Non-APV  
 530 L/C Twin

550 L/C Twin  
 570 F/C Twin  
 580 L/C Twin  
 600 L/C Twin, APV "Laydown"  
 600 L/C Twin, APV  
 600 L/C Twin, Non-APV  
 600 L/C Triple, APV  
 600 L/C Triple  
 650 L/C Twin  
 660 L/C Triple (4-Stroke)

660 L/C Triple (4-Stroke) Turbo

700 L/C Twin, APV "Laydown"  
 700 L/C Twin

800 L/C Twin, APV "Laydown" (Power Up)

800 L/C Twin, APV  
 800 L/C Triple  
 900 L/C Twin, APV  
 900 L/C Triple  
 1000 L/C Twin, APV "Laydown"  
 1000 L/C Triple  
 1100 L/C Twin (4-Stroke)

Year	p/n
'79-'00	0636-128
'99-'08	1639-123
'97-'06	0639-441
'99-'03	1639-605
'80-'96	0636-095
'90-'00	0636-635
'78-'89	0636-096
'93-'95	0636-884
'91-'92	0636-884
'97-'00	0639-224
'86-'91	0636-093
'85-'87	0636-094
'04-'13	3639-539
'03-'06	2639-972
'01-'02	1639-988
'98-'02	0639-115
'87-'91	0636-097
'86	0636-183
'80-'85	0636-098
'91-'05	0636-812
'02-'13	2639-147
'91-'04	0636-812
'04-'09	3639-538
'01-'03	1639-989
'98-'02	0639-115
'01-'02	1639-990
'95-'00	0638-938
'88-'90	0636-409
'03-'08	3006-944
'02	3006-296
'05-'07	3006-961
'04	3006-759
'03-'06	2639-973
'91-'96,	0636-813
'99-'00	
'10-'13	5639-520
'07-'09	4639-664
'01-'04	1639-991
'95-'01	0638-205
'03-'06	1639-991
'93-'97	0638-205
'07-'12	4639-663
'98-'02	0638-205
'07-'13	4639-619

## ACT DRIVE GASKET SETS

### Application

CF, M Series

F Series

Year	p/n
'08	2602-267
'07	2602-191
'07-'08	2602-192

## ACT DRIVE CASE SEALANT

This sealant is recommended for ACT drive cases.

### Description

Sealant, 70 ml

p/n
1048-063

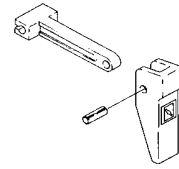

## CHOKE LEVER REPAIR KIT

### Application

Single or Dual Carburetor  
 Triple Carburetor  
 '01-'02 Triple Models

p/n
0636-062
0638-630
1639-835



## TRACK CLIP TOOL

### Description

Track Clip Tool

p/n
0644-194



## OVERLOAD SPRING TOOL

### Description

Overload Spring Tool

p/n
0744-022

## FOX SHOCK REBUILD KITS

### Description

IFP Shock  
 Front Arm Adjustable Shock  
 Clicker Shock  
 Float w/o Reservoir  
 Float w/Reservoir

p/n
1639-769
1639-770
1639-771
2604-796
2603-498



## DRIVE CLUTCH SPRING

Provides smoother, lower RPM clutch engagement.

### Application

'10-'12 800 cc Models

p/n
0646-252



### TUNNEL UPGRADE KIT

Converts '12 F and XF models to a '13 style flat-top tunnel. Includes rear tunnel, bumper, taillight housing, and snow-flap.

Application	Color	p/n
'12 F 800, F 1100, F 1100 Turbo	Unpainted	0637-387
	Black	0637-388
	Pearl White	0637-389
'12 XF 800, XF 1100, XF 1100 Turbo	Unpainted	0637-391
	Black	0637-392
	Pearl White	0637-393

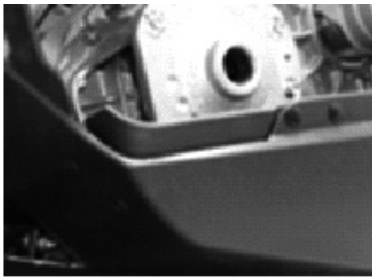

### DEEP SNOW KIT

Reinforces the side panel and belly pan to reduce snow ingestion.

Application	p/n
'12 F 800, F 1100, F 1100 Turbo, M 800, M 800 HCR, M 1100, M 1100 Turbo, M 1100 Turbo HCR, XF 800, XF 800 HC, XF 1100, XF 1100 Turbo, XF 1100 Turbo HC	0637-379

## 120



### HAND WARMER KIT

Includes external hand warmer elements, wiring, and switch.

Application	p/n
'01-'13 120 Models	2639-019

A



B



### WHEEL KITS

Description	Year	p/n
(A) Ski Wheel Kit (includes two 8-in. wheels and mounting hardware)	'01-'13	1639-795
(B) Rear Suspension Wheel Kit (Black) (includes six idler wheels and mounting hardware)	'01-'13	5639-346



### HEAVY DUTY SHOCK KIT

Includes two shock assemblies with springs.

Application	p/n
'01-'05 120 Models	4639-137

# Helmet and Neck Brace Parts



**TXI**



## EYEPORT FOAM PIECE

Description	p/n
'02-'13	
5/8"	4212-292



A



B

## A. CHIN CURTAIN

Description	p/n
Chin Curtain	4212-290

## B. CHIN VENT

Description	p/n
Chin Vent	4222-801
Chrome Chin Vent	4252-032



## SIDE AND TOP VENT COVER KIT

Description	p/n
Vent Cover Kit	4222-800
Chrome Vent Cover Kit (Side Vents Only)	4252-033



## RATCHET KIT

Description	p/n
Ratchet Kit	4212-919
Shield Screws Only (10/pkg)	4212-801



A



B

## A. SHIELD

Description	p/n
Clear	4212-845
Smoke	4212-846
Yellow	4212-847
Silver Mirror	4222-740
Chrome Frame/Clear	4232-880
Chrome Frame/Smoke	4232-881
Chrome Frame/Yellow	4232-882
Chrome Frame/Silver Mirror	4232-883

## B. ELECTRIC SHIELD KIT

Description	p/n
Electric Shield Kit	4212-848
Replacement Elec. Coil Cord	4202-922
Replacement Elec. Dash Cord	4202-923
Accessory Ext. Harness - 24"	1686-457
Replacement Elec. Shield Only	4212-849
Electric Shield Cord Converter (PFP coil cord to TXi dash)	4222-510
Electric Shield Cord Converter (TXi coil cord to PFP dash)	4222-511



## VISOR

Description	p/n
Black	4212-101
Chrome	4232-884
Visor Screws Only (12/pkg)	4222-803





## PFP & PFP YOUTH

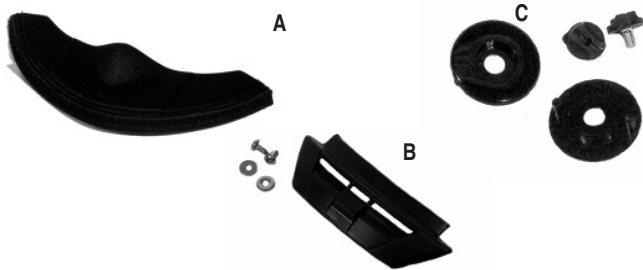

### A. BREATH DEFLECTOR

**Description**  
Breath Deflector

**p/n**  
4982-765

### B. CHIN VENT

**Description**  
Chin Vent

**p/n**  
4992-735

### C. RATCHET KIT

**Description**  
Ratchet Kit  
Shield Screws Only (Metal Thread) 10/pkg

**p/n**  
4912-122  
4212-801



## PFP II



### RATCHET KIT

**Description**  
Ratchet Kit  
Shield Screws Only (10/pkg)

**p/n**  
4982-762  
4212-801



### A. SHIELD

**Description**  
Clear  
Smoke

**p/n**  
4972-463  
4972-464



### A. SHIELD

**Description**  
Clear  
Smoke  
Amber/Yellow

**p/n**  
4212-810  
4212-811  
4212-812

### B. ELECTRIC SHIELD KIT

**Description**  
Electric Shield Kit  
Replacement Electric Coil Cord  
Replacement Electric Dash Cord  
Replacement Electric Shield Only  
Electric Shield Cord Converter (PFP 2011 coil cord to TXi dash)  
Electric Shield Cord Converter (TXi coil cord to PFP 2011 dash)  
Accessory Ext. Harness - 24"

**p/n**  
5222-500  
4202-922  
4202-923  
5222-501  
4222-510  
4222-511  
1686-457



## TEAM ARCTIC (Model Moto X)

### A. VISOR

**Description**  
Black  
Team Arctic Green Graphics (2013)  
Team Arctic Black Graphics (2013)  
Team Arctic Orange Graphics (2013)

**p/n**  
5212-601  
5232-390  
5232-370  
5232-380

### B. BREATH DEFLECTOR

**Description**  
Breath Deflector

**p/n**  
5212-599



**ATV OPEN FACE**



**VISOR**

<b>Description</b>	<b>p/n</b>
Visor	4208-239



**VISOR (2005-2011)**

<b>Description</b>	<b>p/n</b>
Visor	4258-009



**SNO-CROSS SNO PRO (Model Pro-X)**

**VISOR**

<b>Description</b>	<b>p/n</b>
Black	5212-600
Sno Pro Orange Graphics (2013)	5232-400
Sno Pro Black Graphics (2013)	5232-360
Vent, Mouth	5232-409



**SNO/ATV MX (Model 555)**

**A. VISOR**

<b>Description</b>	<b>p/n</b>
Black	4242-950
Chrome	4252-017
Flat Black	4282-920
Visor Screws (10/pkg)	4212-801

**B. FRONT VENT**

<b>Description</b>	<b>p/n</b>
Front Vent	4242-951

**C. TOP VENT COVER**

<b>Description</b>	<b>p/n</b>
Top Vent Cover	4242-953

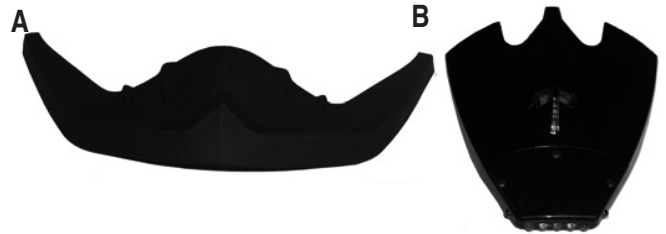

**A. WINDGUARD**

<b>Description</b>	<b>p/n</b>
Windguard	4242-954

**B. TAILLIGHT**

<b>Description</b>	<b>p/n</b>
Taillight	4242-952



## CROSSTEC

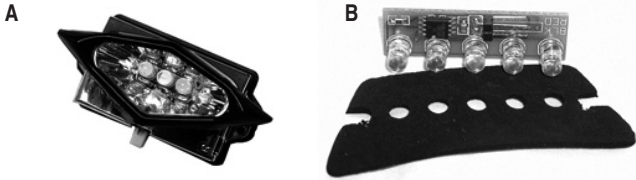

### FRONT & REAR LED LIGHT

Description	p/n
(A) Front Light Assy	4262-900
(B) Rear LED Light Assy	4262-901
(B) Rear Light Cover	4262-902



### FRONT LIGHT LENS

Description	p/n
Front Light Lens	4282-904
Light Button	4282-903



### MIC & SPEAKERS

Description	p/n
VRE Mic. Assy	4262-903
VRE Mic. Foam Assy	4262-904
Headset Speaker (Each)	4262-905



### SHIELD

Description	p/n
(C) Electric Shield Kit ('02-'09)	4282-869
(C) Electric Shield Only ('02-'09)	4282-865
Electric Shield Coil Cord (Not Shown)	4202-922
Electric Shield Power Cord (Not Shown)	4202-923
Accessory Ext. Harness - 24"	1686-457
(A) Magnetic Power Cord	4262-907
(B) Crosstec/TXI Retrofit Headset Electric Shield Cord	4262-716
Clear Replacement Shield	4282-859
VRE Headset Electric Shield Cord (Not Shown)	4262-717
(D) Sun Shield - Smoke	4262-713
(D) Sun Shield - Yellow	4262-714
(D) Sun Shield - Orange	4262-715
Sun Shield Knob w/screw (Not Shown)	4272-997



### BREATH DEFLECTOR

Description	p/n
Breath Deflector (XS-M)	4282-860
Breath Deflector (L-2XL)	4282-861



### RATCHET KIT

Description	p/n
(A) Ratchet Kit	4262-911
Ratchet Disc Set	4282-901
(B) Aluminum Shield Screws (Pair)	4262-910
(C) Top Ratchet Bar	4282-902



**CHIN CURTAIN**

<b>Description</b>	<b>p/n</b>
(A) Chin Curtain	4262-912
(B) Extended Chin Curtain	4282-900



**CHIN PAD**

<b>Description</b>	<b>p/n</b>
Chin Pad	4262-933



**VISOR**

<b>Description</b>	<b>p/n</b>
Visor - Black (2007-2009)	4272-999



**VRE MUSIC ADAPTER CORD**

<b>Description</b>	<b>p/n</b>
(A) Adapter Cord	4262-906
(B) Cat Comm MP3/Satellite Radio Cord - 80"	4292-950



**CHINBAR**

<b>Description</b>	<b>p/n</b>
(A) Replacement Chinbar	4272-998
(B) Chinbar Lock Plate	4282-223

# Arctic Cat Neck Brace

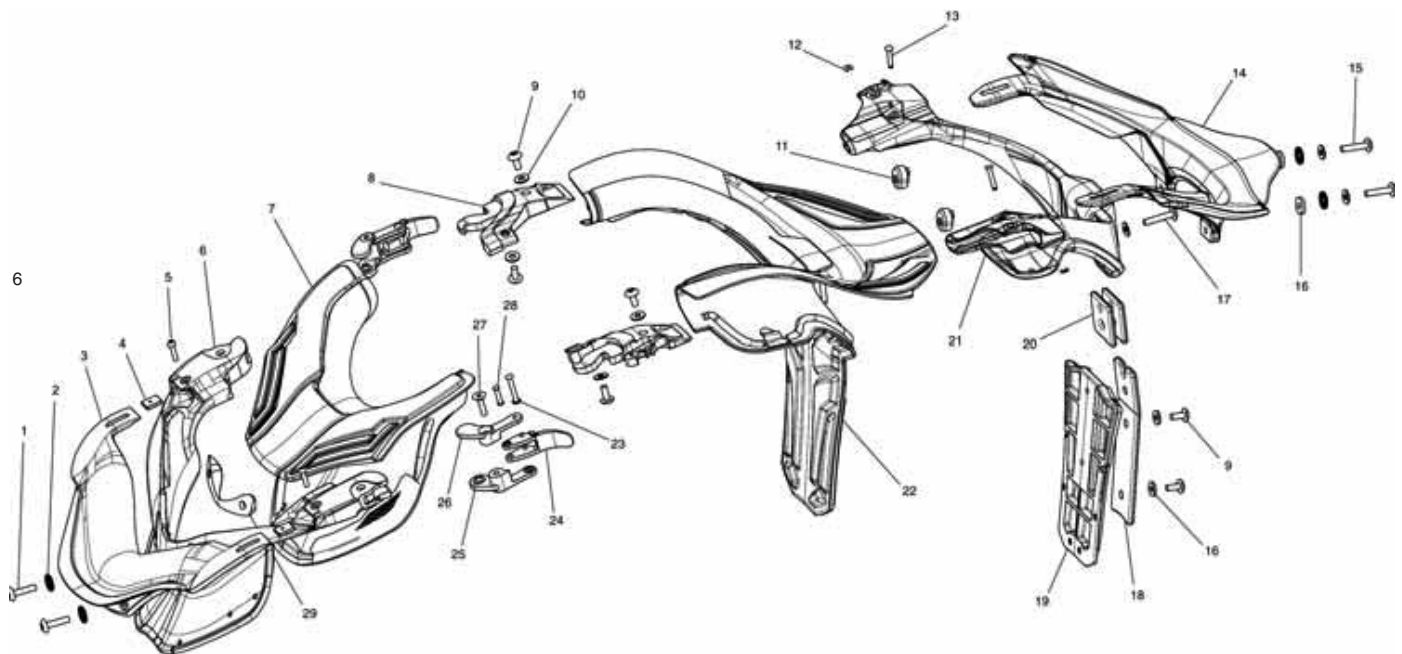

Parts/Components List		QTY
1	BHCS M4 18	2
2	Serrated Washer	2
3	Front Top Plastic	1
4	Front Top Screwplate	2
5	M3 Bolt	2
	Front Lower Plastic	
7	5232-812 / 5232-813	1
8	5232-808 / 5232-809 / 5232-810 / 5232-811	2
9	5232-808 / 5232-809 / 5232-810 / 5232-811	6
10	5232-808 / 5232-809 / 5232-810 / 5232-811	5
11	5232-814 / 5232-815	2
12	5232-814 / 5232-815	2
13	5232-814 / 5232-815	2
14	5232-814 / 5232-815	1
15	5232-814 / 5232-815	2

Parts/Components List		QTY
16	5232-814 / 5232-815	4
17	5232-814 / 5232-815	1
18	5232-816	1
19	5232-816	1
20	5232-816	2
21	5232-814 / 5232-815	1
22	5232-812 / 5232-813	1
23	5232-807	2
24	5232-807	2
25	5235-807	2
26	5232-807	2
27	5232-807	2
28	5232-807	2
29	Front Screw Plate	1

# High Altitude Kits

Models	Altitude	p/n	Components
F570 T570 BC 570	5-9,000 ft.	5639-489	(2) 6505-029 Pilot Jet 35 (3) 0746-695 Cam Arm 67g ** (1) 0748-700 Torque Bracket - 36° *
	Over 9,000 ft.	5639-490	(2) 6505-029 Pilot Jet 35 (3) 0746-670 Cam Arm 65g ** (1) 0748-700 Torque Bracket - 36° *
BC 570 XT	5-9,000 ft.	5639-627	(2) 6505-029 Pilot Jet 35 (3) 0746-669 Cam Arm 60g ** (1) 0748-700 Torque Bracket - 36° *
	Over 9,000 ft.	5639-490	(2) 6505-029 Pilot Jet 35 (3) 0746-669 Cam Arm 60g ** (1) 0748-700 Torque Bracket - 36° *
BC Z1 XT	5-9,000 ft.	5639-935	(3) 0746-828 Cam Arm ** - 57g
	Over 9,000 ft.	5639-936	(3) 0746-829 Cam Arm ** - 52g (1) 0646-433 Clutch Spring - Gold Stripe - 75/275 lb
BC Z1 XT GS	Over 9,000 ft.	5639-937	(3) 0746-828 Cam Arm ** - 57G (1) 0646-433 Clutch Spring - Gold Stripe - 75/275 lb
TZ1 (Non Turbo)	5-9,000 ft.	4639-687	(3) 0746-678 Cam Arm 55g ** (1) 0748-662 Torque Bracket - 36° *
	Over 9,000 ft.	4639-639	(3) 0746-663 Cam Arm 52g ** (1) 0748-662 Torque Bracket - 36° *
F800	5-9,000 ft.	5639-973	(3) 0746-671 Cam Arm 70g ** (1) 0748-729 Torque Bracket - 36° *
	Over 9,000 ft.	6639-191	(3) 0746-695 Cam Arm 67g ** (1) 0646-229 Clutch Spring - Yellow/White (1) 0748-757 Torque Bracket - 36°
F1100 (Non Turbo)	5-9000 ft.	5639-978	(3) 0746-663 Cam Arm 52g **
	Over 9,000 ft.	5639-979	(3) 0746-705 Cam Arm 49g **
SP 500	5-9000 ft.	5639-507	(3) 0746-666 Cam Arm 55g **
	Over 9,000 ft.	5639-508	(3) 0746-661 Cam Arm 52g **
F5 LXR	5-9,000 ft.	4639-639	(3) 0746-663 Cam Arm 52g ** (1) 0748-662 Torque Bracket - 36° *
	Over 9,000 ft.	4639-640	(3) 0746-792 Cam Arm 47g ** (1) 0748-662 Torque Bracket - 36° *
XF800 LXR, SP	3-6,000 ft.	6639-193	(3) 0746-716 Cam Arm 73g ** (1) 0646-229 Clutch Spring - Yellow/White (1) 0748-757 Torque Bracket - 36°
	6-9,000 ft.	6639-192	(3) 0746-671 Cam Arm 70g ** (1) 0646-229 Clutch Spring - Yellow/White (1) 0748-757 Torque Bracket - 36°
	Over 9,000 ft.	6639-191	(3) 0746-695 Cam Arm 67g ** (1) 0646-229 Clutch Spring - Yellow/White (1) 0748-757 Torque Bracket - 36°
XF800 HC	0-3,000 ft.	5639-975	(3) 0746-672 Cam Arm 75g ** (1) 0748-731 Torque Bracket - 42/40 *
	3-6,000 ft.	5639-971	(3) 0746-716 Cam Arm 73g ** (1) 0748-757 Torque Bracket - 36°
	Over 9,000 ft.	5639-974	(3) 0746-695 Cam Arm 67g ** (1) 0748-757 Torque Bracket - 36°
XF1100 (Non Turbo)	3-6,000 ft.	5639-977	(3) 0746-674 Cam Arm 55g **
	6-9,000 ft.	5639-978	(3) 0746-663 Cam Arm 52g **
	Over 9,000 ft.	5639-979	(3) 0746-705 Cam Arm 49g **
XF1100 (Turbo)	6-9,000 ft.	5639-980	(1) 0748-747 Torque Bracket - 42/40 *
	Over 9000 ft.	5639-980	(1) 0748-747 Torque Bracket - 42/40 *
M8	0-3,000 ft.	5639-975	(3) 0746-672 Cam Arm 75g ** (1) 0748-731 Torque Bracket - 42/40 *
	3-6,000 ft.	5639-227	(3) 0746-716 Cam Arm 73g **
	Over 9,000 ft.	5639-989	(3) 0746-695 Cam Arm 67g **
M1100 (Non Turbo)	0-3,000 ft.	5639-976	(3) 0746-632 Cam Arm 60g - **
	3-6,000 ft.	5639-977	(3) 0746-674 Cam Arm 55g **
	Over 9,000 ft.	5639-979	(3) 0746-705 Cam Arm 49g **

■NOTE: M8, M1100 set up at factory for altitude of 6-9,000 ft.  
\* w/bearing assembly \*\* w/set screw

■NOTE: For more information on the High Altitude Kit Exchange Program, see page 1.

## 2013 Optional Rear Suspension Springs

Model	Standard Rear Arm Spring	Optional Rear Arm Spring	Spring Type
BC 570, T570, TZ1	1704-146/147	L 1704-678/679 H 1704-360/361	SQUARE SQUARE
F5/F570	1704-504/505	L 1704-576/577 H 1704-710/711	SQUARE SQUARE
F 800 F 1100 RR/Sno Pro	1704-576/577	L 1704-354/355 H 1704-560/561	SQUARE SQUARE
BC XT GS	1704-842/843	L N/A H 1704-384/385	SQUARE SQUARE
BC 570 XT/BC Z1 XT	1704-852/853	L 1704-562/563 H 1704-842/843	SQUARE SQUARE
XF 1100 LXR (141)/ XF 1100 Turbo LXR/XF 800 LXR (141)	2703-502	L 2703-386* H 2704-010*	COIL COIL
Sno Pro 500	1704-382/383	L N/A H 2704-382/383	SQUARE SQUARE
Sno Pro 600 CC	2704-382 R 2704-383 L	L 2704-384/385 H 2704-380/381	SQUARE SQUARE
Sno Pro 600 SC	2704-380 R 2704-381 L	L 2704-382/383 H N/A	SQUARE SQUARE

\* Coil over shock

### Rear Suspension Spring Selection Chart

This chart was compiled to assist technicians in fine-tuning the Arctic Cat rear suspension when the original springs are not satisfactory and a softer or firmer ride is desired. A longer spring in areas (D) and (E) can be selected if cut off to match the original spring. The replacement spring must match the original spring in areas (D) and (E).

■NOTE: The wire diameter and length of the spring have a large influence over the valving of the shocks.

■NOTE: When installing Springs (p/n 1704-148/149), you must also use the white Plastic Sleeves (p/n 2604-379).

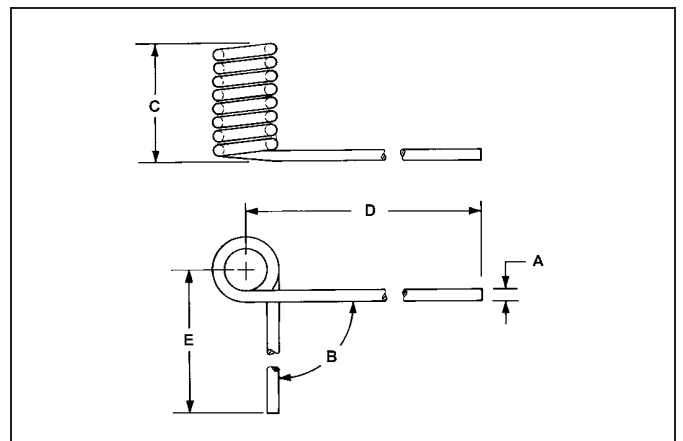



# Rear Suspension Springs

P/N	Replaced By	Wire Diameter (A)	Angle (B)	Number of Coils	Coil Width (C)	Length (D)	Length (E)	Spring Type
0604-054/053		.406	65°	7.75	3.88	17.50	4.50	Round
0604-118/117	1704-174/175	.460	45°	9.00	4.75	17.50	4.50	Round
0604-272/273		.437	90°	9.00	4.80	17.50	5.50	Round
0604-282/283		.437	75°	9.00	4.80	17.50	5.50	Round
0604-288/289		.460	60°	9.00	4.75	17.50	4.50	Round
0604-290/291		.490	60°	9.00	5.02	17.50	4.50	Round
0604-314/315**		.460	90°	9.00	5.03	17.50	5.50	Round
0604-400/401	1704-182/183	.406	90°	8.75	4.32	17.50	5.50	Round
0604-454/455*		.437	90°	9.00	4.80	17.50	4.50	Round
0604-474/475	1704-072/073	.406	90°	7.75	3.88	17.50	4.50	Round
0604-492/493		.406	90°	8.75	4.32	15.75	5.50	Round
0604-584/585	0704-986/987	.406	90°	8.75	4.32	18.10	5.70	Round
0604-592/593		.460	83°	8.75	4.80	15.75	5.50	Round
0604-654/655		.437	83°	8.75	4.59	20.00	5.70	Round
0604-660/661		.437	83°	8.73	4.59	18.10	5.70	Round
0604-746/747		.390	90°	8.75	4.32	19.75	5.70	Round
0604-970/971*		.421	90°	8.75	4.43	15.90	5.70	Round
0704-822/821		.452	90°	8.75	4.45	18.75	5.50	Round
0704-856/857**		.437	90°	8.75	4.59	20.00	5.70	Round
0704-876/877	1604-616/617	.375	90°	5.75	3.00	15.62	5.12	Square
0704-886/887**	1604-060/601	.460	77°	8.75	4.85	20.00	5.50	Round
0704-888/889**	1604-062/063	.437	75°	8.75	4.60	18.00	5.50	Round
0704-890/891	1604-600/601	.359	90°	5.75	3.00	15.62	5.12	Square
0704-892/893	1604-818/819	.405	75°	8.75	4.32	19.00	5.50	Square
0704-902/901		.405	80°	7.75	3.92	19.00	5.50	Square
0704-908/909**		.437	75°	8.75	4.60	18.50	5.50	Round
0704-926/927	2604-352/353	.375	80°	5.75	3.00	18.50	5.12	Square
0704-934/935	2604-356/357	.405	90°	5.75	3.00	18.50	5.12	Square
0704-938/939	1604-442/443	.452	90°	8.75	4.53	16.00	5.70	Round
0704-944/945**	1604-604/605	.452	75°	8.75	4.62	18.75	5.50	Round
0704-968/969		.437	90°	6.75	3.50	18.50	5.12	Square
0704-988/989**		.437	90°	8.75	4.59	18.10	5.70	Round
0704-990/991	1604-178/179**	.421	77°	8.75	4.32	20.00	5.50	Round
0704-994/995	1604-388/389**	.452	75°	8.75	4.60	18.00	5.50	Round
1604-065/064		.421	75°	8.75	4.45	18.00	5.50	Round
1604-067/066	1704-083/082	.460	75°	8.75	4.83	18.00	5.50	Round
1604-076/077**		.460	97°	9.00	4.53	16.00	5.70	Round
1604-078/079**	1704-300/301	.437	83°	8.75	4.56	21.00	5.70	Round
1604-144/145***	1704-302/303	.437	77°	8.75	4.52	22.00	8.00	Round
1604-146/147***		.421	77°	8.75	4.52	22.00	8.00	Round
1604-149/148**	1704-289/288	.460	77°	8.75	4.84	22.00	8.00	Round
1604-194/195**	1704-088/089	.460	90°	8.75	4.53	16.00	6.70	Round
1604-224/225**	1704-290/291	.460	83°	8.75	4.53	21.00	5.70	Round
1604-381/380***	1704-135/134	.452	77°	8.75	4.97	22.00	8.00	Round
1604-608/609	1704-344/345	.437	83°	8.75	4.59	20.75	5.70	Round
1604-739/740**		.437	75°	8.75	4.60	16.00	5.50	Round
1704-044/045		.405	75°	8.75	4.32	18.50	5.50	Square
1704-146/147		.405	70°	6.75	4.32	18.50	5.50	Square
1704-148/149		.437	75°	7.75	4.25	18.50	5.50	Square
1704-184/185		.421	90°	8.75	4.43	18.10	5.70	Round
1704-260/261		.405	70°	7.75	3.85	18.50	5.50	Square
1704-352/353		.375	80°	7.75	3.80	18.50	5.50	Square
1704-354/355		.375	75°	8.75	4.32	18.50	5.50	Square
1704-360/361		.405	70°	5.75	4.00	18.50	5.50	Square
1704-382/383		.359	90°	5.75	3.00	15.62	4.60	Square
1704-384/385		.375	90°	5.75	3.00	15.62	4.60	Square
1704-444/445		.437	90°	6.75	3.65	18.50	5.50	Square
1704-504/505		.405	85°	6.75	3.65	18.50	5.50	Square
1704-560/561		.405	85°	6.75	3.65	18.50	5.48	Square
1704-562/563		.405	70°	6.75	4.50	18.50	5.50	Square
1704-566/567		.405	85°	6.75	3.65	18.50	5.36	Square
1704-576/577		.405	94°	6.75	3.65	18.50	5.50	Square
1704-678/679		.405	78°	6.75	4.00	18.50	5.50	Square
1704-710/711		.405	75°	6.75	3.65	18.50	5.50	Square
1704-808/809		.405	90°	8.00	3.87	18.50	5.50	Square
1704-842/843		.437	80°	7.75	4.50	18.50	5.50	Square
1704-852/853		.437	75°	7.75	4.50	18.50	5.50	Square
2604-044/045		.452	90°	8.75	4.68	18.75	5.50	Round
2604-566/567*		.488	85°	5.75	4.00	18.75	5.50	Round
2604-612/613		.405	70°	6.75	4.00	18.50	5.50	Square
2604-898/899*		.465	80°	5.00	3.40	18.75	5.50	Round
2704-224/225		.437	105°	8.80	3.75	15.62	4.70	Square
3604-488/489		.437	80°	7.75	4.50	18.50	5.50	Square
2703-387****		.393		12		13.00		Coil/190 lb
2703-386****		.393		13		13.00		Coil/160 lb
2703-949****		.357		11		13.00		Coil/145 lb
2704-010****		.406		13		12.75		Coil/210 lb
2703-896****		.421		12		12.40		Coil/260 lb

\*Long leg of spring is bent inward \*\*Short leg of spring is bent inward \*\*\*Must be cut to correct length \*\*\*\* Coil over shock • Titanium • Spring color is Platinum

# Drive Belt Application Guide

<b>1994</b>	
Puma, Puma Deluxe,	
Puma 2-Up .....	0227-103
Jag, Jag 440Z .....	0227-103
Cheetah Models .....	0227-103
Cougar .....	0227-103
Pantera .....	0227-103
Prowler EFI .....	0227-103
EXT 580 Models .....	0627-012
Panther Deluxe .....	0227-103
Wildcat EFI .....	0627-011
ZR Models .....	0627-012
Thundercat .....	0627-010
<b>1995</b>	
Puma, Puma Deluxe,	
Puma 2-Up .....	0227-103
Jag, Jag Deluxe .....	0227-103
Panther .....	0227-103
Bearcat 340 .....	0627-013
Bearcat 440 & 550 0627-014	
Cougar .....	0627-012
Prowler .....	0627-012
Pantera .....	0627-012
EXT .....	0627-012
EXT Powder Special .....	0627-010
Wildcat, Wildcat Touring .....	0627-010
Thundercat .....	0627-010
Z440 .....	0627-012
ZR440, ZR580 .....	0627-012
ZR700 .....	0627-010
ZRT800 .....	0627-010
<b>1996</b>	
Puma, Puma Deluxe,	
Puma 2-Up .....	0227-103
Jag, Jag Deluxe, Jag L/C .....	0227-103
Z440, Panther Deluxe,	
Panther L/C .....	0627-012
Bearcat 340 .....	0627-013
Bearcat 440 & 550 .....	0627-014
Cougar, Cougar 2-Up,	
Cougar M/C .....	0627-012
Pantera .....	0627-012
EXT EFI Models .....	0627-012
EXT 580 .....	0627-012
EXT 580 Powder Special .....	0627-010
Wildcat Models .....	0627-010
Thundercat, ZRT 800,	
ZRT 600 .....	0627-010
ZR 580 Models, ZR440 .....	0627-012
<b>1997</b>	
Puma, Puma Deluxe,	
Puma 2-Up .....	0627-012
Jag, Jag Deluxe .....	0627-012
Panther, Panther L/C .....	0627-012
Z440, ZL440 .....	0627-012
Bearcat 340 .....	0627-013
Bearcat 440 & 550 .....	0627-014
Cougar, Cougar M/C .....	0627-012
Pantera .....	0627-012
EXT EFI Models .....	0627-012
Powder Special EFI .....	0627-012
Thundercat, ZRT 800,	
ZRT 600 .....	0627-010
ZR 580, ZR440 .....	0627-010
EXT 600, Powder Extreme .....	0627-010
Powder 580 Carb .....	0627-010
<b>1998</b>	
Jag 340, Panther 340 .....	0627-012
Jag 440, Jag 440 DLX .....	0627-012
Z 440, Panther 440 .....	0627-012
Panther 550 .....	0627-021
Bearcat 340 .....	0627-013
Bearcat 440,	
Bearcat Wide Track .....	0627-014
Cougar, Cougar DLX,	
Cougar M/C .....	0627-021
Pantera 580 .....	0627-021
Pantera 800 .....	0627-020
EXT EFI .....	0627-020
EXT EFI DLX .....	0627-021
EXT 600, EXT 600 Touring .....	0627-020
Powder Special,	
Powder Special EFI .....	0627-020
Powder Extreme .....	0627-020
Thundercat, Thundercat M/C .....	0627-020
ZRT 600, ZRT 800 .....	0627-020
ZR 600, ZR 600 EFI .....	0627-020
ZL 440 .....	0627-021
ZL 500, ZR 500 .....	0627-020
ZR 440 .....	0627-020

<b>1999</b>	
Jag 340 DLX, Panther 340 .....	0627-012
Jag 440, Jag 440 DLX .....	0627-012
Panther 440 .....	0627-012
Panther 550 .....	0627-021
Bearcat 340, Bearcat 440 I .....	0627-013
Bearcat 440 II,	
Bearcat Wide Track .....	0627-014
Pantera 580 EFI .....	0627-021
Pantera 800 .....	0627-020
Triple Touring 600 .....	0627-020
Powder Special 500 EFI .....	0627-020
Powder Special 600 Models .....	0627-020
Powder Special 700 .....	0627-020
Thundercat, Thundercat M/C .....	0627-020
Z 370 .....	0627-021
ZL 440 .....	0627-021
ZL 500 Models,	
ZL 600 Models .....	0627-020
ZR 500 Models .....	0627-020
ZR 600 Models .....	0627-020
ZR 700 .....	0627-020
ZRT 600, ZRT 800 .....	0627-020
<b>2000</b>	
Bearcat 340 .....	0627-013
Bearcat 440 I/440 II/	
Wide Track .....	0627-014
Pantera Models .....	0627-020
Panther 340/440 .....	0627-012
Panther 550 .....	0627-021
Powder Special Models .....	0627-020
Thundercat Models .....	0627-020
Triple Touring 600 .....	0627-020
Z Models .....	0627-021
ZL 440/550 .....	0627-021
ZL 500/580/600/700 .....	0627-020
ZR Models .....	0627-020
ZRT Models .....	0627-020
<b>2001</b>	
Bearcat W/T .....	0627-014
Mountain Cat Models .....	0627-020
Pantera Models .....	0627-020
Panther 370 Models .....	0627-013
Panther 440 Models .....	0627-012
Panther 550 .....	0627-021
Thundercat .....	0627-020
Triple Touring 600 .....	0627-020
Z Models .....	0627-021
ZL Models .....	0627-020
ZR Models .....	0627-020
ZRT Models .....	0627-020
<b>2002</b>	
Bearcat W/T .....	0627-014
Mountain Cat Models .....	0627-020
Pantera 550 .....	0627-021
Pantera Models (EFI) .....	0627-020
Panther Models .....	0627-021
Thundercat .....	0627-020
Z Models .....	0627-021
ZL Models .....	0627-020
ZR Models .....	0627-020
ZRT 600 .....	0627-020
<b>2003</b>	
Bearcat W/T .....	0627-026
Firecat 500/600 Models .....	0627-020
Firecat 700 Models .....	0627-020/035*
4-Stroke Touring/Trail .....	0627-013
Mountain Cat Models .....	0627-020
Pantera 550 .....	0627-021
Pantera Models (EFI) .....	0627-020
Panther Models .....	0627-021
Z Models .....	0627-021
ZL Models .....	0627-020
ZR Models .....	0627-020/035*
<b>2004</b>	
Bearcat 570 .....	0627-013
Bearcat W/T .....	0627-033
Firecat 500 Models .....	0627-020
Firecat 600/700 Models .....	0627-031
King Cat .....	0627-020
Mountain Cat Models .....	0627-020
Pantera 550 .....	0627-021
Pantera Models (EFI) .....	0627-020
Panther Models .....	0627-021
Sabercat 500 .....	0627-020
Sabercat 600/700 Models .....	0627-031
T660 Touring .....	0627-021
T660 Turbo Models .....	0627-028
Z Models .....	0627-021
ZR Models .....	0627-032

<b>2005</b>	
Bearcat 570 .....	0627-013
Bearcat W/T .....	0627-033
Firecat 500 Models .....	0627-034
Firecat 600/700 Models .....	0627-034
King Cat .....	0627-020
M-Series .....	0627-036
Pantera 550 .....	0627-021
Pantera 600 EFI .....	0627-020
Panther Models .....	0627-021
Sabercat 500 .....	0627-020
Sabercat 600/700 Models .....	0627-035
T660 Touring .....	0627-021
T660 Turbo Models .....	0627-028
Z Models .....	0627-021
ZR 900 Models .....	0627-032
<b>2006</b>	
Bearcat 570 .....	0627-013
Bearcat W/T .....	0627-033
Bearcat W/T Turbo .....	0627-049
Crossfire Models .....	0627-036
Firecat 500 Models .....	0627-044
Firecat 600 EFI r .....	0627-020
Firecat 600/700 Models	
(w/o Reverse) .....	0627-044
Firecat 700 EFI r .....	0627-035
King Cat Models .....	0627-020
M-Series Models .....	0627-036
Panther 370/570 Models .....	0627-021
Panther 660 Models .....	0627-013
Sabercat 500/600 Models .....	0627-020
Sabercat 700 Models .....	0627-035
T660 Touring .....	0627-013
T660 Turbo Models .....	0627-048
Z Models .....	0627-021
ZR 900 EFI Models .....	0627-045
<b>2007</b>	
Bearcat 570 .....	0627-013
Bearcat W/T .....	0627-033
Bearcat W/T Turbo .....	0627-049
Crossfire 5/6/8 .....	0627-046
Crossfire 1000 .....	0627-060
F-Series 5/6/8 .....	0627-046
F1000 .....	0627-060
Jaguar Z1 .....	0627-047
M-Series .....	0627-046
Panther 370/570 .....	0627-021
Panther 660 .....	0627-013
T660 .....	0627-048
Z 370/570 .....	0627-021
<b>2008</b>	
Bearcat 570 .....	0627-013
Bearcat W/T .....	0627-033
Bearcat W/T Turbo .....	0627-049
Crossfire 5/6/8 .....	0627-046
Crossfire 1000 .....	0627-060
F-Series 5/6/8/570 .....	0627-046
F1000 .....	0627-060
Jaguar Z1 .....	0627-047
M-Series 6/8 .....	0627-046
M1000 .....	0627-060
Panther 370 .....	0627-021
Panther 660 .....	0627-013
600 Sno Pro .....	0627-066
T500/T570 .....	0627-046
TZ1 .....	0627-047
<b>2009</b>	
Bearcat 570 .....	0627-067
Bearcat 570 XT .....	0627-046
Bearcat Z1 XT .....	0627-047
Crossfire 500 .....	0627-067
Crossfire 6/8/R8 .....	0627-046
Crossfire 1000/R1000 .....	0627-060
F5/570 .....	0627-067
F6/8 .....	0627-046
F1000 Sno Pro .....	0627-060
M6/8/HCR .....	0627-046
M1000 .....	0627-060
T500/570 .....	0627-067
TZ1 .....	0627-047
TZ1 Turbo .....	0627-066
Z1 .....	0627-047
Z1 Turbo .....	0627-066
600 Sno Pro (Sno Cross) .....	0627-070
600 Sno Pro (Cross Country) .....	0627-066

<b>2010</b>	
Bearcat 570 .....	0627-067
Bearcat 570 XT .....	0627-046
Bearcat Z1 XT .....	0627-047
Crossfire 6 .....	0627-046
Crossfire 8, CFR 8, CFR 1000 .....	0627-060
F5 LXR/570 .....	0627-067
F6 Sno Pro/8/8 Sno Pro .....	0627-046
M6/8/HCR .....	0627-046
M1000 .....	0627-060
T570 .....	0627-067
TZ1 .....	0627-069
TZ1 Turbo/LXR .....	0627-073
Z1 .....	0627-069
Z1 Turbo/EXT/ Sno Pro .....	0627-073
Sno Pro 500 .....	0627-047
Sno Pro 600 (Sno Cross) .....	0627-075
Sno Pro 600 (Cross Country) .....	0627-076
<b>2011</b>	
Bearcat 570/LTD .....	0627-067
Bearcat 570 XT .....	0627-046
Bearcat Z1 XT/LTD .....	0627-047
Crossfire 6 .....	0627-046
Crossfire 8, CFR 8, CFR 1000 .....	0627-060
F5 LXR/570 .....	0627-067
F6 Sno Pro/8 EXT/LXR/	
8 Sno Pro LTD .....	0627-046
M6/8/HCR .....	0627-046
M1000 Sno Pro .....	0627-060
T570 .....	0627-067
TZ1/LXR LTD .....	0627-069
TZ1 Turbo LXR LTD .....	0627-073
Z1 LXR .....	0627-069
Z1 Turbo EXT/LXR/Sno Pro .....	0627-073
Sno Pro 500 .....	0627-047
Sno Pro 600 (Sno Cross) .....	0627-075
Sno Pro 600 (Cross Country) .....	0627-076
<b>2012</b>	
BC 570 .....	0627-067
BC 570 XT .....	0624-046
BC Z1 XT .....	0627-047
F5 LXR, F570 .....	0627-067
F 800 .....	0627-083
F 1100 .....	0627-081
F 1100 Turbo .....	0627-082
M 800 .....	0627-084
M 1100 .....	0627-081
M 1100 Turbo .....	0627-082
T570 .....	0627-067
TZ1 Touring .....	0627-069
TZ1 Turbo Touring .....	0627-082
XF 800 .....	0627-083
XF 1100 .....	0627-081
XF 1100 Turbo .....	0627-073
XF 800 High Country .....	0627-084
Sno Pro 500 .....	0627-047
Sno Pro 600 .....	0627-085
<b>2013</b>	
Bearcat 570 .....	0627-067
Bearcat 570 XT .....	0627-046
Bearcat Z1 XT .....	0627-047
F5 LXR, F570 .....	0627-067
F800 .....	0627-083
F1100 .....	0627-081
F1100 Turbo .....	0627-082
M800 .....	0627-084
M1100 .....	0627-081
M1100 Turbo .....	0627-082
T570 .....	0627-067
TZ1 .....	0627-069
TZ1 Turbo .....	0627-073
XF800 .....	0627-083
XF 800 High Country .....	0627-084
XF1100 .....	0627-081
XF1100 Turbo .....	0627-082
Sno Pro 500 .....	0627-047

## Drive Belt Dimension Chart

BELT P/N	LENGTH	WIDTH
0100-088	43.125 ± .188 inch	1.188 inch
0100-092	43.813 ± .188 inch	1.250 inch
0227-011	44.000 ± .188 inch	1.250 inch
0227-014	45.500 ± .188 inch	1.250 inch
0227-016	45.063 ± .188 inch	1.250 inch
0227-019	43.250 ± .188 inch	1.250 inch
0227-020	46.688 ± .188 inch	1.250 inch
0227-030	43.500 ± .188 inch	1.375 inch
0227-100	45.500 ± .188 inch	1.375 inch
0227-103	43.625 ± .125 inch	1.375 inch
*0627-002	43.625 ± .188 inch	1.375 inch
*0627-004	43.625 ± .188 inch	1.375 inch
*0627-006	43.625 ± .188 inch	1.375 inch
*0627-010	47.750 ± .188 inch	1.375 inch
*0627-011	45.750 ± .188 inch	1.375 inch
*0627-012	47.750 ± .188 inch	1.375 inch
0627-013	49.000 ± .188 inch	1.437 inch
0627-014	49.000 ± .188 inch	1.437 inch
*0627-020	48.071 ± .188 inch	1.406 inch
*0627-021	47.750 ± .188 inch	1.385 inch
*0627-031	47.750 ± .178 inch	1.382 inch
*0627-032	44.570 ± .178 inch	1.448 inch

BELT P/N	LENGTH	WIDTH
*0627-033	50.285 ± .188 inch	1.437 inch
*0627-034	44.024 ± .178 inch	1.448 inch
*0627-035	47.750 ± .178 inch	1.400 inch
*0627-036	45.024 ± .178 inch	1.448 inch
*0627-044	44.706 ± .178 inch	1.448 inch
*0627-045	45.223 ± .178 inch	1.448 inch
*0627-046	45.998 ± .178 inch	1.448 inch
*0627-047	43.547 ± .178 inch	1.448 inch
*0627-048	46.986 ± .178 inch	1.448 inch
*0627-049	48.162 ± .178 inch	1.448 inch
*0627-059	48.162 ± .178 inch	1.448 inch
**0627-060	45.998 ± .178 inch	1.448 inch
*0627-067	45.394 ± .178 inch	1.406 inch
*0627-069	42.953 ± .178 inch	1.406 inch
*0627-070	44.250 ± .178 inch	1.448 inch
***0627-073	43.547 ± .178 inch	1.448 inch
**0627-075	44.250 ± .178 inch	1.448 inch
**0627-076	43.547 ± .178 inch	1.448 inch
*0627-081	46.378 ± .178 inch	1.448 inch
***0627-082	46.259 ± .178 inch	1.448 inch
**0627-083	47.519 ± .178 inch	1.448 inch
***0627-084	47.519 ± .178 inch	1.448 inch
***0627-085	48.149 ± .178 inch	1.448 inch

\*High Performance \*\*Improved Compression Resistance; Improved Heat Resistance \*\*\*Best Compression Resistance; Best Heat Resistance

■ **NOTE: The difference between a \* drive belt and a \*\* drive belt of the same dimension is hardness. A \*\* drive belt is more flexible and if used in place of a \* drive belt, the engine will run at a lower RPM.**

## Promotional Products



### ARCTIC CAT SHOPPING BAGS

Frosted poly bag featuring custom Arctic Cat logo. Available in three sizes.

Description	p/n
<b>Frosted Poly Shopping Bags — Pkg. Qty. 100</b>	
12" x 15" Bag	4024-100
18" x 18" Bag	4024-101
25" x 28" Bag	4024-102



### GIFT BAGS & TISSUE (SOLD SEPARATELY)

Soft white gift bag with black Arctic Cat logo. Lime green tissue paper also available. Gift Bags available in three sizes.

Description	p/n
<b>Gift Bags — Pkg. Qty. 50</b>	
8" x 10" x 4" — Small	4294-000
20" x 16" x 6" — Large	4294-002



### PENCIL

Description	p/n
<b>Pencil — Pkg. Qty. 10</b>	
Black w/Arctic Cat logo - #2 Pencil	5293-817



### PEN

Description	p/n
<b>Pen — Pkg. Qty. 10</b>	
Lime Plastic w/Black Logo - Ball-Point Pen w/Clip - Black Ink	5239-816



### BALLOONS

Description	p/n
<b>Balloons — Pkg. Qty. 40</b>	
Assorted Colors	5219-090

# Index

■NOTE: Bolded Items are not found in the CAtalog.

**#**  
120 ACCESSORIES ..... 69

**A**  
A-ARM KIT, 38" ..... 40  
ACCESSORY ADAPTER ..... 64  
AIRBOX KIT, SPLIT ..... 66  
ALTITUDE KITS, HIGH ..... 76  
ANTIFREEZE ..... 61  
AVALANCHE AIRBAG ..... 38  
AVALANCHE BEACONS ..... 38  
AVALANCHE PROBE ..... 39  
AXLE KIT, LIGHTWEIGHT FRONT ..... 41

**B**  
BAGS  
Backpack ..... 38  
Dimensions ..... 11  
Foam Beverage Holder ..... 20  
Gear ..... 17,36,42  
Handlebar ..... 18,36  
Heater ..... 18  
Mountain Pack ..... 36  
Rack Bag ..... 18  
Saddlebags ..... 19  
Seat Pack ..... 19  
Tank ..... 19  
Trunk, Firecat ..... 19  
Tunnel Pack ..... 16,36,42  
Underhood ..... 19  
Windshield ..... 17,19,37  
Replacement Hardware ..... 20  
BATTERY CHARGERS/MAINTAINERS ..... 64  
BELTS, DRIVE  
Application Guide ..... 78  
Dimension Chart ..... 79  
Holder ..... 64  
BILLET ACCESSORIES ..... 28-29, 37  
BODY PANELS, VENTED ..... 39  
BUMPER ..... 21-22,44

**C**  
CAM ROLLER, HI-TEMP ..... 41  
CARGO SLEDS ..... 44  
CHOKE LEVER REPAIR KIT ..... 68  
CLEANERS ..... 62-63  
COVERS  
Arctic Cat Canvas Covers ..... 14  
Custom ..... 14  
Dust ..... 15  
Half ..... 15  
Headlight ..... 33  
Premium ..... 14  
Team Arctic ..... 14  
Undercover Liner ..... 15  
Replacement Straps ..... 15

**D**  
DC Power Kit ..... 24  
DRIVE CLUTCH SPRING ..... 68  
DOLLY  
Cat Caddy ..... 56  
Shop ..... 57  
DEEP SNOW KIT ..... 69

**E**  
ELECTRIC START KIT ..... 24  
ENGINE HEATER ..... 24

**F**  
FLUID  
ACT Gearcase ..... 60  
Fox Float ..... 62  
Flush ..... 60  
FUEL  
High Octane Race ..... 62  
De-Icer ..... 61  
Injection & Carburetor Cleaner ..... 61  
Stabilizer ..... 61  
FUEL PUMP REPAIR KITS ..... 67

**G**  
GASKET SETS ..... 68  
GAUGE, TEMPERATURE ..... 65  
GEAR SET, LOW RATIO ..... 45  
GOGGLE HOLDER ..... 17, 37  
GREASE ..... 62  
GRAPHIC KITS ..... 28  
GRIP PLATES ..... 33

**H**  
HANDLEBAR  
Grip Adhesive ..... 67  
Grips ..... 29  
Heavy-Duty ..... 65  
Muffs ..... 18  
Risers ..... 40, 65  
Stand ..... 56  
Steering Post Stand ..... 56  
HAND GUARDS ..... 30  
HAND WARMER KIT ..... 69  
HAND WARMERS, PASSENGER ..... 45  
HEATED SEAT KIT ..... 24  
HEATED SHIELD ADAPTER ..... 57  
HELMET PARTS ..... 70-74  
HITCH KITS ..... 23,44  
HOOD LATCH REPAIR KIT ..... 66  
HOOD FLARES ..... 34

**I**  
ICE SCRATCHERS ..... 39

**L**  
LIFT  
Sled ..... 56  
Front End ..... 56  
LIGHT  
Backup ..... 42  
Bar ..... 43  
Strobe ..... 43  
LOCTITE ..... 67  
LUBE  
Transmission ..... 60  
Chain ..... 60

**M**  
MIRRORS ..... 34

**N**  
NECK BRACE PARTS ..... 75

**O**  
OIL  
Engine ..... 59  
Shock ..... 60-61  
OVERLOAD SPRING TOOL ..... 68

**P**  
PAINT ..... 58  
PINK ACCESSORY KITS ..... 28  
PROMOTIONAL PRODUCTS ..... 80

**R**  
RACK  
Billet ..... 37  
Cargo ..... 22,42  
Sport ..... 22  
Crossfire ..... 22  
Procross ..... 22  
Proclimb ..... 22,37  
Touring ..... 23  
Mat/Pad ..... 41,45  
M Series ..... 37  
Strap ..... 37  
RADIATOR KIT ..... 45  
RAIL BRACE KIT ..... 65  
RECOIL HANDLE ..... 28,35  
REMOTE START KIT ..... 24

**S**  
SAW, POCKET ..... 39  
SEALANT ..... 67-68  
SEAT COVER, GRIPPER ..... 33  
SEAT KIT, 2-UP ..... 21  
SEAT KIT, PASSENGER ..... 46  
SEAT, MOUNTAIN ..... 37-38  
SEAT, THIRD ..... 42  
SHOCKS  
FOX Float ..... 27  
Airshox Guards ..... 27  
Airshox Pump ..... 27  
Rebuild Kits ..... 68  
SHOVELS ..... 38  
SIDE RAILS ..... 42  
SKI  
Plastic ..... 31  
Skins ..... 44  
SKID PLATES ..... 33  
SNOBUNJE ..... 40  
SNOWFLAPS ..... 34-35,55  
SNOW MESH ..... 32  
SNOW PLOW  
Blades ..... 45  
Push Frame ..... 45  
SPARK PLUGS ..... 67  
Caddy ..... 65  
Caps ..... 66  
SPEEDOMETER/TACHOMETER ..... 65  
SPRING CHART, OPTIONAL ..... 76-78  
SPRING KIT, OVERLOAD ..... 46  
STAND, JACK ..... 56  
STEERING POST, TELESCOPIC ..... 40  
STEERING POST, VERTICAL ..... 39  
STUD ACCESSORIES ..... 51-55  
SWAY BAR KITS ..... 66  
SWITCH GUARDS ..... 39

**T**  
TANK  
Grips ..... 37  
Jacket ..... 19  
Pads ..... 36  
TAPE ..... 57  
TETHER SWITCH ..... 23  
THROTTLE BLOCK ..... 66  
TIE-DOWNS ..... 57  
TOE HOLD ..... 35  
TOW ROPE ..... 57  
TRACKS ..... 47-48  
TRACK CLIP TOOL ..... 68  
TRAIL GROOMER ..... 46  
TUNNEL FLARES ..... 34,41  
TUNNEL GRIPS ..... 33  
TUNNEL PROTECTOR KIT ..... 55  
TUNNEL RAILS ..... 21  
TUNNEL UPGRADE KIT ..... 69

**W**  
WEARBARS ..... 49-50  
WEAR STRIPS ..... 34  
WHEELS, IDLER ..... 35  
WHEEL KITS ..... 41,66,69  
WINCH KIT, WARN ..... 43  
WINDSHIELDS/WINDSCREENS ..... 25-26  
WINDSHIELD MOUNTING RING ..... 26