

**can-am**



**PARTS, ACCESSORIES & RIDING GEAR**

**ATV 2011**









# BRP

## PARTS & ACCESSORIES

<b>OUTLANDER™</b>	4
<b>RENEGADE™</b>	12
<b>DS 450™</b>	18
<b>DS 250™</b>	23
<b>TRACK SYSTEM</b>	24
<b>PLOUGH ACCESSORIES</b>	27
<b>WINCHES</b>	30
<b>COVERS</b>	32
<b>BAGS</b>	33
<b>MULTI-FIT</b>	34
<b>PRIME TLC FOR YOUR ATV</b>	35
<b>RIDING GEAR</b>	36
<b>RACE</b>	36
<b>ADVENTURE</b>	43
<b>RECREATIONAL</b>	47
<b>HELMETS</b>	53
<b>MAINTENANCE</b>	62
<b>LICENSED PRODUCTS</b>	65
<b>SIZING CHART</b>	66

Read the Operator's Guide and watch the Safety DVD before driving. **BRP** highly recommends that all-terrain vehicle (ATV) drivers take a training course. ATVs can be hazardous to operate. For both ATVs and side-by-side vehicles (SSVs), the operator and passenger should wear a helmet, eye protection and other protective clothing. Respect the minimum age as required by law. For SSVs, fasten lateral net and seat belt at all times and passenger must be at least 12 years old and able to hold handgrips and plant feet while seated against the backrest. Never carry passengers on any ATV not specifically designated for such use. For ATVs, **BRP** recommends not to carry any passengers under the age of 12. However, users must always respect any applicable law establishing a minimum age for riding an ATV/SSV. Always remember that riding and alcohol/drugs don't mix. Never engage in stunt driving. Avoid excessive speeds and be particularly careful on difficult terrain. Ride responsibly. **BRP** urges you to "TREAD LIGHTLY" on public and private lands. Preserve your future riding opportunities by showing respect for the environment, local laws and the rights of others when you ride. Always ride responsibly and safely. Never carry passengers on any ATV not specifically designated for such use. Highly skilled operators under controlled conditions appear in this brochure. Do not attempt these manoeuvres if they are beyond your skill level. Pictures taken outward, on private land. **BRP** reserves the right, at any time, to discontinue or change specifications, prices, designs, features, models or equipment without incurring obligation. Some models depicted herein may include optional equipment or not be available in your country. Prices are based on Manufacturer Suggested Retail Prices. Please refer to your authorised Can-Am dealer for your own personalised quotation. Taxes are not included. Depending on location, products are distributed by **BRP** European Distribution SA, **BRP** US Inc., **BRP** Australia Pty Ltd. or **Bombardier Recreational Products Inc.**™, ® and the **BRP** logo are trademarks of **Bombardier Recreational Products Inc.** or its affiliates. **UNI** is a trademark of **UNIFILTER Inc.** **TWIN AIR** is a trademark of **Twin Air USA.** **KYB** is a registered trademark of **Kayaba.** **WARN** is a trademark of **Warn Industries Inc.** **YUASA** is a registered trademark of **YUASA Batteries Inc.** **NGK** is a registered trademark of **NGK Spark Plugs, Ltd.** **Smith** is a registered trademark of **Smith Sport Optics, Inc.** **Chamude** is a registered trademark of **Kolon Industries, Inc.** **Clarino** is a trademark of **Kuraray Co. Ltd.** **Teflon HT, Teflon HP and Kevlar** are trademarks of **E.I. DuPont de Nemours & Co.** **Lexan** is a trademark of **General Electric (GE).** **Primaloft One and Primaloft Cresta** are registered trademarks of **Albany International Corp.** **Windows** is a trademark of **Microsoft group of companies** and is used under license from **Microsoft.** **CARLISLE** is a trademark of **Carlisle Companies.** **FOX** is a trademark of **FOX Racing Canada.** All other trademarks are the property of their respective owners.

© 2010 **Bombardier Recreational Products Inc (BRP).** All rights reserved.



# OUTLANDER

- XT FRONT BUMPER KIT ▶ P.6
- REAR TRUNK BOX ▶ P.7
- PASSENGER WIND DEFLECTORS ▶ P.7
- FRONT RACK EXTENSIONS ▶ P.8
- MUDGUARD KIT ▶ P.8
- FRONT SHOCK PROTECTORS ▶ P.15
- FRONT BAG ▶ P.33
- MIRROR ▶ P.34





**A-ARM PROTECTORS**

Made with high strength aluminium for more protection to the CV joint and rubber boots. Drain hole to release water, mud and debris. Unique design with embossed Outlander name. Easy to install. Sold in pairs.  
703500524

**FRONT ALUMINIUM SKID PLATE**

Stamped aluminium. Protection for the front portion of the frame. Use in conjunction with the central chassis skid plate (715000636) for full frame protection.  
715000548

**CENTRAL CHASSIS SKID PLATE**

Protect your frame from the unexpected – a must-have for rugged terrain. Stamped 3 mm [1/8"] aluminium construction. Recessed bolt holes. Cannot be installed with Plough Mounting Kit.  
**Renegade & Outlander 500, 650, 800 & Outlander MAX**  
715000636

**FOOTWELL PROTECTOR PLATES**

Bump up the impact protection to the footwells. 3 mm [3/16"] aluminium construction. Use in conjunction with the central skid plate (703500570 or 715000636). Sold in pairs.  
715000547

**TRAILING ARM PROTECTORS**

3 mm [1/8"] aluminium construction. Replace stock plastic protectors. Sold in pairs.  
**Renegade & Outlander** - 715000311

**REAR DIFFERENTIAL PROTECTOR**

3 mm [3/16"] aluminium construction. Replaces stock plastic protector.  
**Renegade & Outlander** - 715000285

**REAR SKID PLATE**

3 mm [3/16"] aluminium plate provides additional protection for your frame. A must when riding on extremely rugged terrain.  
**Renegade & Outlander 500, 650, 800** - 715000609  
**Outlander MAX 500, 650, 800** - 715000610  
**Must be installed with the Central and Front Skid Plate** (703500570). **Outlander MAX 400 only** - 703500381  
**Outlander 400 only** - 703500382

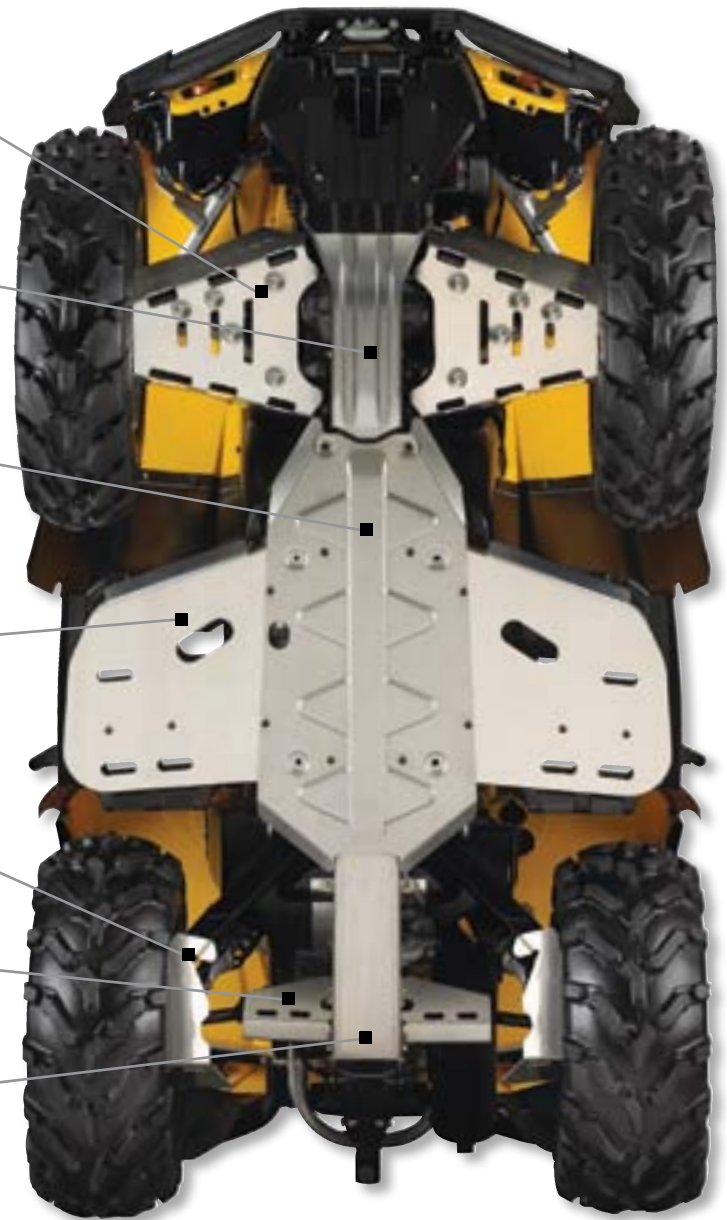

**CENTRAL AND FRONT SKID PLATE**

Two-piece 5 mm [3/16"] aluminium full-body skid plate designed to protect frame and engine case from rough terrain conditions.  
**Outlander 400 only** - 703500570





**LOWER BUMPER EXTENSION**

Adds protection to lower front plastic fascia. Easy to install. No drilling required. Removable for Apache™ Track Kit installation. Must be installed with XT Front Bumper Kit (715000670). 715000635 **Black**



**XT REAR BUMPER KIT**

Adds on to stock bumper to convert your Outlander into an XT™ model. Large tube construction with textured black finish. 2009 800R only & 2010-2011 - 715000671 **Black**  
2006-2009, except 800R - 703500550 **Black**  
2004-2005 - 703500349 **Black**



**XT FRONT BUMPER KIT**

Adds on to stock bumper to convert your Outlander into an XT model. Large tube construction with textured black finish. 2009 800R only & 2010-2011 - 715000670 **Black**  
2006-2009, except 800R - 703500551 **Black**  
2004-2005 - 703500348 **Black**



**REAR CARGO BOX**

Convert your Outlander MAX into a very versatile vehicle in only 30 seconds. Designed exclusively for the Outlander MAX, this latest-generation rear cargo box is built tough and made of high-resistance polyethylene plastic. Featuring a removable rear tailgate that also conveniently installs in the centre of the box. Since it can handle a maximum payload of 118 kg [260 lb.], you will really hit paydirt with this cargo box. Dimensions: 88 cm [35"] W X 54 cm [21"] D X 17 cm [7"] H. Outlander MAX 2006-2011 - 715000734 **Black**



**FOOTPEG KIT**

Made of aluminium, the Footpeg Kit provides maximum integrated grip. Larger than stock model, it gives more stability during vigorous riding. Kick-up end generates added grip during hard cornering. Sold in pairs. 715000916



**FOOTPEG EXTENSIONS**

Made of aluminium, the Footpeg Extensions provide grip in all weather and riding conditions. Use in conjunction with footpeg kit (715000916). Sold in pairs. 715000996







**HIGH WINDSHIELD KIT**

These top of the line Windshield Kits provide excellent wind protection. Can be used on standard, XT and LTD models. Easy to install and remove. Can-Am® branded.

- Outlander 500, 650 & 800
- 715001015 Yellow
- 715001016 Red
- 715001017 Tinted Black



**ULTRA HIGH WINDSHIELD KIT**

Provides superior wind protection. 10 cm [4"] higher windshield. Added substructure to control vibration. Can-Am branded and colour matched. Can be used on standard, XT and LTD models. Easy to install and remove.

- Outlander 500, 650 & 800
- 715001018 Yellow
- 715001019 Red
- 715001020 Tinted Black



**WINDSHIELD KIT**

Can be used with or without handlebar protectors. Includes steering cover. Easy to install and remove.

- Outlander 400 - 703500444



**PASSENGER HEATED GRIPS**

Heat control can be set to High or Low. Ideal for replacing stock passenger handles. Added passenger comfort. Easily removable when summer comes. Easy to install.

- Outlander MAX 2006-2011 - 715000634



**REAR TRUNK BOX**

Perfect fit with vehicle. Made of impact resistant polyethylene. Fully sealed lid. Tray quick-hooks to box. Equipped with lid key lock. The molded handle makes lifting and moving the box easy. Robust double wall lid. Improved trunk latch and attachment system on rack. Easy-install quick attach system (715000273) available as an option. Fits any ATV on the market. Cannot be used with Rear Rack Extensions (703500537 & 703500538).

- 2006-2011 - 715000626 Black

**QUICK ATTACH/DETACH SYSTEM FOR REAR TRUNK BOX**

(Not illustrated)

- 2006-2011 - 715000273



**PASSENGER WIND DEFLECTORS**

These wind deflectors fit snugly around the passenger handles and provide total comfort while riding. Easy to install and remove.

- Outlander MAX 2006-2011 - 715000233
- Outlander MAX 2004-2005 - 715000231







**MUDGUARD KIT**

Offers more protection from dirt and debris. Extra flair for that ruggedly cool look. Kit includes front and rear extensions and all mounting hardware.

- Outlander 500, 650, 800 - 715000533 Black**
- Outlander 400 2006-2011 - 715000297 Black**
- Outlander 400 2004-2005 - 715000296 Black**



**FENDER PROTECTORS**

Provide extra fender protection when you are in tight situations. 25 mm [1"] diameter steel construction with textured black finish.

- Outlander 2006-2011 - 703500544 Black**
- Outlander MAX 2006-2011 - 703500546 Black**



**FRONT RACK EXTENSIONS**

Offers 100 mm [4"] or 178 mm [7"] of clearance with the existing racks. Secure bulky loads with its sturdy tube construction. Textured black finish.

- |  |                                 |
|--|---------------------------------|
| <b>Medium Profile 100 mm [4"]</b><br>(Not illustrated) | <b>High Profile 178 mm [7"]</b> |
| 2006-2011 - 703500536 Black                            | 2006-2011 - 703500535 Black     |



**REAR RACK EXTENSIONS**

Offers 100 mm [4"] or 178 mm [7"] of clearance with the existing racks. Secure bulky loads with its sturdy tube construction. Textured black finish.

- |  |                                 |
|--|---------------------------------|
| <b>Medium Profile 100 mm [4"]</b><br>(Not illustrated) | <b>High Profile 178 mm [7"]</b> |
| 2006-2011 - 703500538 Black                            | 2006-2011 - 703500537 Black     |



**FRONT HITCH**

Front hitch for Outlander with or without a winch. This hitch offers 340 kg [750 lb.] of towing capacity. Needs to be installed with the winch fairlead bracket (715000696) for all Outlander models equipped with a winch.

- 2006-2011 - 703500421 Black**





**FRONT HPG SHOCK KIT**

High pressure gas (HPG) shocks. Provides enhanced Outlander ride, handling and control. Razor sharp calibration for even the most demanding riders. Fade-free performance. Sold in pairs.  
**Outlander 650, 800 Standard models - 715000303**



**FRONT HPG SHOCK KIT WITH SPRINGS**

**Outlander 650, 800 XT models - 715000304**

**REAR HPG SHOCK KIT WITH SPRINGS**

(Not illustrated)  
**Outlander 650, 800 Standard and XT models - 715000305**



**XT HANDLEBAR PROTECTOR KIT**

Add handlebar protection with our XT-style kit.  
**Outlander 500, 650, 800 - 703500553 Black**  
**Outlander 400 2005-2011 - 715000271 Black**  
**Outlander 400 2004 - 715000272 Grey**



**FRONT SPRING KIT**

Front heavy-duty springs. Stiffer than factory installed front springs for more precise front suspension behaviour. Ideal for snow ploughing or heavy load transportation applications. Sold in pairs.  
**Outlander 650, 800 Standard and XT models - 715000306**



**NEW GPS PROTECTOR**

Provides extra protection from mud and dust. Covers GPS support when GPS is removed.  
**Outlander LTD 2010-2011**  
**715001210 - Black**



715000961

**GPS ADAPTOR FOR OUTLANDER LTD WINDSHIELD**

Kit needed to install your GPS from LTD model when using a Can-Am windshield.  
**Outlander 2009 and prior - 715000309**  
**Outlander LTD 2010-2011 - 715000961**





**NEW SNORKEL KIT**

The only way to tackle extreme muddy conditions. Snorkel kit comes complete with redesigned air-box with extended air intake and a new extended CVT exhaust outlet conveniently integrated into the upper gauge pod, maximising muddy condition performance. Standard equipment on X mr model.

**Outlander 650 & 800R 2010-2011**  
715001136



**NEW OUTLANDER X XC FRONT PRE-RUNNER BUMPER**

Lightweight yet sturdy aluminium bumper provides maximum frontal protection. Incorporated front skid plate, reinforced tubing and still works with a winch.

**Outlander 800R 2009 & Outlander 2010-2011**  
715001123 Aluminium



**NEW RADIATOR RELOCATOR KIT**

Relocates radiator to top mount position to prevent mud packing. For use in extreme muddy conditions, providing maximum performance. Includes all brackets, hardware and hoses (radiator not included).

**Outlander 650 & 800R 2010-2011**  
715001178 Black



**NEW X MR TRACTION PLATES**

Provide extra foot grip for driver when riding in extreme muddy conditions. Help driver maintain ideal riding position to maximise vehicle traction. Not meant for a passenger.

**Outlander Max**  
715001137 Aluminium



**NEW OUTLANDER X XC WINCH MOUNTING KIT**

Required for winch installation on models equipped with the X xc bumper. Must be used in conjunction with winch mounting kit (703500547) and roller fairlead (715000011) (Winch not included)

**Outlander X xc 2011**  
(or Outlander with X xc bumper)  
715001121 Black



**RECEIVER HITCH**

Powder-coated finish. Does not affect ground clearance. Trailer ball not included. Rear hitch plate (715000286) is required for Renegade and Outlander X xc 2011.  
**Renegade & Outlander with hitch plate kit -**  
715000325







**GUN-BOOT**

The best way to transport your rifle or shotgun. This high-impact case securely holds your rifle while providing a padded dust-proof and water-resistant protection.  
**Outlander & Rally - 715000028 Black**

**GUN-BOOT SUPPORT**

(Not illustrated)  
 Used in conjunction with the gun-boot. Attaches to the rear rack.  
**Outlander & Rally - 715000029 Black**



**NONSKID LUGGAGE RACK STRIPS**

Rubber strips you can apply to your front and rear luggage racks to maintain your cargo in position. Helps keep your luggage rack scratch free. Easy to install. Sold in packs of 4.  
**Outlander 2006-2011 - 703500569 Black**

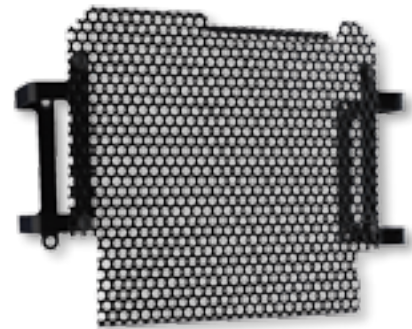

**RADIATOR PROTECTOR**

Metal shield which mounts over radiator face providing protection from stones and branches.  
**Outlander 2006-2011 - 703500543 Black**  
**Outlander & Rally 2004-2005 - 703500427 Black**



**FLASHER AND HORN KIT**

Complete flasher and horn kit. Integrates to vehicle. Easy to install. Not for road use.  
**Outlander 800R 2009-2011 - 715000695**



**REWIND STARTER KIT**

Complete manual rewind assembly.  
**Outlander 400 EFI 2010-2011 - 715001034**



# RENEGADE

- CENTRE CONSOLE DAY LIGHT ▶ P.14
- REAR ALUMINIUM RACK ▶ P.14
- FRONT SHOCK PROTECTORS ▶ P.15
- HANDLEBAR WIND DEFLECTORS ▶ P.17
- FULL WRAP ALUMINIUM MOUNTING KIT ▶ P.17
- MIRROR ▶ P.34





**A-ARM PROTECTORS**

Add protection to your Renegade lower A-arm with this high-strength aluminium protector with drain hole to release water, mud and debris. 3 mm [ $\frac{1}{8}$ "] aluminium construction. Easy to install. Replaces stock plastic protectors. Engraved Can-Am logo. Sold in pairs.  
715000287

**CENTRAL CHASSIS SKID PLATE**

Protect your frame from the unexpected – a must-have for rugged terrain. Stamped 3 mm [ $\frac{1}{8}$ "] aluminium construction. Recessed bolt holes. Cannot be installed with Plough Mounting Kit.  
**Renegade & Outlander 500, 650, 800 & Outlander MAX**  
715000636

**FOOTWELL PROTECTOR PLATES**

Bump up the impact protection to the footwells and structure. 3 mm [ $\frac{1}{8}$ "] aluminium construction. Use in conjunction with a central chassis skid plate (715000636). Sold in pairs.  
715000686

**REAR DIFFERENTIAL PROTECTOR**

3 mm [ $\frac{1}{8}$ "] aluminium construction. Replaces stock plastic protector.  
**Renegade & Outlander - 715000285**

**TRAILING ARM PROTECTORS**

3 mm [ $\frac{1}{8}$ "] aluminium construction. Replace stock plastic protectors. Sold in pairs.  
**Renegade & Outlander - 715000311**

**REAR SKID PLATE**

3 mm [ $\frac{1}{8}$ "] aluminium plate provides additional protection for your frame. A must when riding on extremely rugged terrain.  
**Renegade & Outlander 500, 650, 800 - 715000609**







**NEW MUD GUARD KIT FOR RENEGADE**

Integrated extended fender flairs for sporty look and full body protection from dirt and water. Kit of 4 includes front and rear extensions and all mounting hardware.

Renegade 2007 to 2011  
715001115 Black



**X PACKAGE REAR SHOCK & SPRING KIT**

Rebound and dual speed compression adjustable gas shocks. Kit includes matching springs and hardware. Sold in pairs.

2008-2011 - 715000538



**X PACKAGE FRONT SHOCK & SPRING KIT**

Rebound and dual speed compression adjustable gas shocks. Kit includes matching springs and hardware. Sold in pairs.

715000536



**FRONT SWAY BAR KIT**

Enhances vehicle stability and control during hard cornering.

Renegade 2010-2011 - 715000967



**REAR ALUMINIUM RACK**

14 kg [30 lb.] capacity. Compact, lightweight aluminium construction. Engraved Can-Am logo. Stamped 5052 aluminium centre plate. Easy to install.

715000242



**CENTRE CONSOLE DAY LIGHT**

Mountable on top end of centre console. Enhance look of vehicle.

715000691



**REAR HITCH PLATE**

Includes bolt-on hitch plate and hardware.

Renegade & Outlander X xc 2011 - 715000286







**UNI-FOAM FILTER**

Ease of maintenance. Can be easily washed, re-oiled and re-used when subject to severe dusty/muddy environments. Contains a rigid adaptor with an added flair providing retention of the air filter.  
**Outlander 500, 650, 800 & Renegade 2010-2011 and prior, except 800R and 650 2010-2011 - 715000310**



**NEW CAN-AM FOAM AIR FILTER BY TWINAIR**

Maximises performance by increasing air flow throughout RPM range. Maintenance-friendly, i.e. just wash, re-oil and re-use after riding in severely dusty/muddy environments.  
**Renegade & Outlander 800R 2009-2011 and 650 2010 & 2011 - 715001130**



**CVT AIR INTAKE**

Designed to relocate and maximises height of the CVT air intake to prevent belt slippage in deep snow or muddy conditions. Equipped with integrated CVT pre-filter to also reduce dust and extend CVT and belt life.  
**Renegade 500, 800 2007-2009 - 715000984**  
**Outlander 500, 650, 800 2008-2009 - 715000970**



**AIR PRE-FILTER**

Filters out even the tiniest of contaminants in dusty conditions. Extends service period. Use in conjunction with stock filter. Air filter not included.  
**DS 450 & Outlander 400 - 707800293**



**AIR PRE-FILTER**

Adds extra protection to your engine in harsh riding conditions. Filter blocks particles larger than 0.005". Note: A pre-filter is necessary to maintain the vehicle warranty when an Apache Track kit is installed.  
**Renegade & Outlander 500, 650 & 800 2008 and prior, 500, 650 2009 and 500 2010 - 715000291**

**AIR BOX PRE-FILTER**

(Not illustrated)  
 Add extra protection to your engine in harsh riding conditions. Filter blocks particles larger than 0.005". Note: A pre-filter is necessary to maintain the vehicle warranty when an Apache Track kit is installed.  
**Renegade & Outlander 650 2010-2011, 800R 2009-2011 715000908**



**HEATED HAND GRIP KIT**

Keep your hands warm while riding with this easy-to-install hand grip kit. Includes a 3-position switch, switch cover, wiring harness, hand grip and handlebar end cap. Grips are 12 cm [4 7/8"] long with an interior diameter of 22 mm [7/8"]. Grip heat control can be set to High (20 watts) or Low (10 watts).  
**Renegade & Outlander - 715000322**



**HEATED THROTTLE LEVER ASSEMBLY**

Improved heating element provides faster warm-up time and increased maximum temperature. For a perfect fit and finish, designed especially for your Can-Am ATV. Kit includes a 3-position switch, switch cover, wiring harness and throttle lever assembly.  
**Renegade & Outlander - 715000584**



**SHIFTER LOCK**

Locking device locks transmission shifter in "Park" position. Minimum 5,000 key combination. Fully integrated.  
**Renegade & Outlander 500, 650, 800 2009-2011 - 715000689**  
**Outlander 400 - 715000690**



**NEW SHOCK PROTECTOR**

Provides X-package shock rods with additional protection against pitting.  
**Fit X-package KYB shocks except DS 450 X xc 715001209 Black**



**FRONT SHOCK PROTECTORS**

Feature ventilation holes. Sold in pairs.  
**Renegade & Outlander - 715500301**



**NEW LOCKABLE GAS TANK CAP**

Protects your fuel. Meets latest EPA requirements.  
**Renegade & Outlander - 860200387 Black**





**XT RIM**

Made of aluminium . Upgrade for non XT models.  
**Renegade & Outlander, except Outlander 800 2006**  
 Front - 705400648      Rear - 705500986



**XT-P RIM**

Made of aluminium . Upgrade for non XT models.  
**Renegade & Outlander, except Outlander 800 2006**  
 Front - 705400687      Rear - 705501019



**LTD RIM**

Made of aluminium . Upgrade for non XT models.  
**Renegade & Outlander, except Outlander 800 2006**  
 Front - 705400683      Rear - 705501015

NOTE: MATCHING NUTS - 250100100 Black and 250100082 Chrome — MATCHING CAP - 705400680 Black

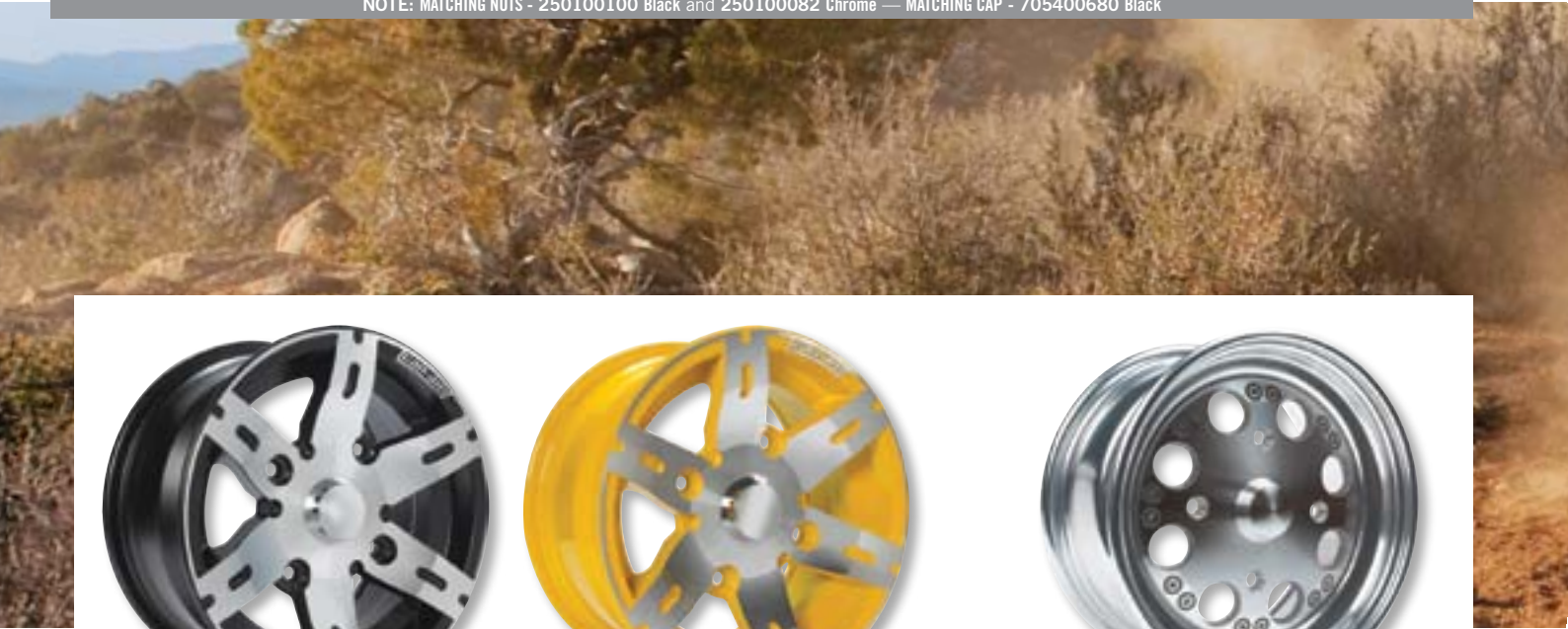

**XTR CUSTOM WHEEL KIT**

Custom Can-Am XTR branded 12" [30.5 cm] painted aluminium rims. Includes matching chrome nuts and centre covers. Set of 4.

**Renegade & Outlander, except Outlander 800 2006** - 715000611 Black - 715000612 Yellow



**RENEGADE RIM**

Centre cast aluminium rims.  
**Renegade & Outlander, except Outlander 800 2006**  
 Front 705400506      Rear 705500837



**COLOURED FINS FOR RIMS**

Plastic fins that enhance appearance of your vehicle. Pack of 8.  
**Fits on following wheels: XT, XT-P and LTD 2010-2011** (705500986, 705501015, 705501019, 705400687, 705400648, 705400683)  
 705400681 Yellow  
 705400950 Steel Grey (Not illustrated)



**BEAD LOCK**

Cast aluminium . Must be installed on rims 705400794 and 705501137.  
**Renegade & Outlander 650 and 800, except 800 2006** - 705400841



**RENEGADE X RIM**

Centre cast aluminium rims. Welded exterior and interior reinforcement rings. Needs to be installed with Bead Lock (705400841).  
**Renegade & Outlander 650 and 800, except 800 2006**  
 Front - 705400794      Rear - 705501137





**FULL WRAP ALUMINIUM MOUNTING KIT**

Lightweight black die cast aluminium construction. Includes complete hardware. Handlebar wind deflectors sold separately.  
**Renegade, Outlander 500, 650, 800 & DS 450 - 715000545**



**SHORT ALUMINIUM MOUNTING KIT**

Lightweight black die cast aluminium construction. Includes complete hardware. Handlebar wind deflectors sold separately.  
**Renegade, Outlander 500, 650, 800 & DS 450 - 715000513**



**HANDLEBAR WIND DEFLECTORS**

Rugged injected plastic construction with Can-Am logo. Includes removable cap for air flow adjustment. Mounting kit sold separately.  
**Renegade, Outlander 500, 650, 800 & DS 450**  
 715000733 Yellow / Black (Not illustrated)  
 715000537 White / Black  
 715000525 Black / Yellow



**MIRROR KIT FOR HANDLEBAR WIND DEFLECTORS**

Handlebar wind deflector mount design. To be used with handlebar wind deflectors. Sold in pairs.  
**Renegade, Outlander 500, 650, 800 & DS 450 - 860200080**



**ALUMINIUM TAPERED HANDLEBAR**

22 mm - 28 mm [7/8" - 1 1/8"] tapered handlebar made of 6061-T6 aluminium. Includes all hardware, centre steering foam and cover.  
**Renegade & Outlander 500, 650, 800 - 715000550**



# DS 450

- X PACKAGE CHASSIS SKID PLATE ▶ P.19
- X PACKAGE NERF BARS ▶ P.19
- REAR ALUMINIUM BASKETS ▶ P.19
- FRONT SHOCK PROTECTORS ▶ P.21
- NUMBER PLATE ▶ P.21
- X PACKAGE FRONT ALUMINIUM BUMPER ▶ P.21
- X PACKAGE ADJUSTABLE FRONT SHOCKS ▶ P.21
- SPEEDOMETER ▶ P.22





### A-ARM PROTECTORS

Lightweight injected plastic A-arm protectors provide strong protection for lower aluminium A-arm. Can-Am branding visible from top and underneath vehicle. Easy installation, no holes to drill. Sold in pairs. Does not fit DS 450 X mx.

715000517 **Black**  
715000589 **Yellow**

### X PACKAGE CHASSIS SKID PLATE

Lightweight and strong full chassis skid plate. 5052 3 mm [ $\frac{1}{8}$ "] stamped aluminium construction. Recessed bolt holes. Includes all necessary hardware. 715000506

### FRONT FENDER EXTENSIONS

Lightweight aluminium extension connects the front fender to the nerf bar. Sold in pairs. 715000514

### X PACKAGE NERF BARS

Strong lightweight rectangular aluminium tubing provides extra protection for assertive riding. Complete with mounting hardware and black webbing. Must be installed with Rear Aluminium Baskets (715000673). Sold in pairs.

2009 - 715000672  
2008 and prior - 715000505

### REAR ALUMINIUM BASKETS

For direct replacement of stock plastic version. 3 mm [ $\frac{1}{8}$ "] 5052 aircraft aluminium construction and 22 mm [ $\frac{7}{8}$ "] tubing. Stronger construction than stock model. Must be installed with X Package Nerf Bars (715000672).

**X Package 2009** - 715000673  
**Can be installed with or without X Package Nerf Bars (715000505).**  
715000526

### X PACKAGE SWING ARM SKID PLATE

Lightweight protection for your swing arm, rear disc, sprocket and chain. 5052 5 mm [ $\frac{3}{16}$ "] aluminium construction. Replaces stock plastic protector. 715000507

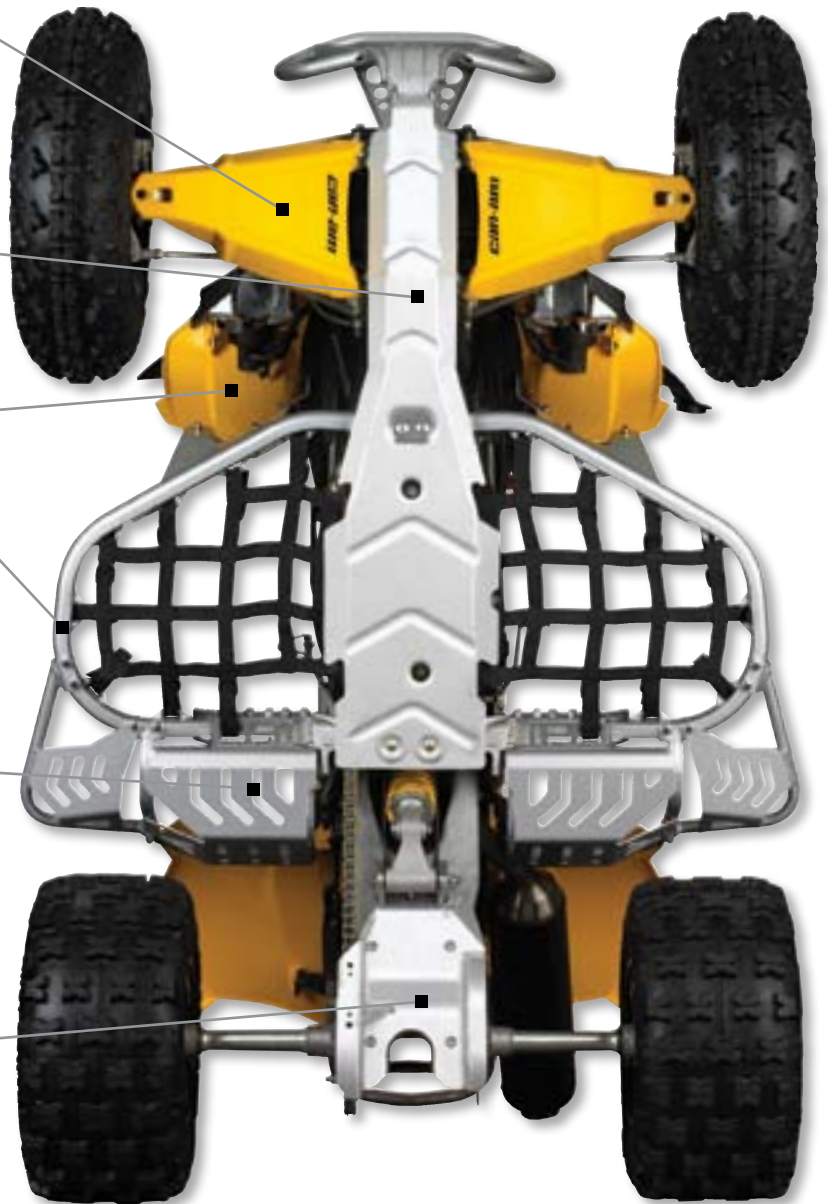





### X XC FRONT RIM KIT

Dimensions: 10" x 5" [25 cm x 13 cm] diameter.  
ITP T-9<sup>†</sup> Trac-Lock<sup>®</sup> rims. Sold in pairs.  
715000902



### X XC REAR RIM KIT

Dimensions: 9" x 8" [23 cm x 20 cm] diameter.  
ITP T-9 Trac-Lock rims. Sold in pairs.  
715000905



### X MX FRONT RIM KIT

Dimensions: 10" x 5" [25 cm x 13 cm] diameter.  
ITP T-9 GP rims. Sold in pairs.  
715000903



### X MX REAR RIM KIT

Dimensions: 8" x 8" [20 cm x 20 cm] diameter.  
ITP T-9 Trac-Lock rims with bead lock and inside reinforcement. Sold in pairs.  
715000906



### X PACKAGE REINFORCED RIM KIT

Black painted aluminium rims with exterior reinforcement ring. Sold in sets of 4. Tyres not included. Always respect tyre size appropriate for your vehicle. Bead lock with inside reinforcement.  
715000510





### X PACKAGE ADJUSTABLE FRONT SHOCKS

Ultra-high performance KYB fully adjustable shocks. Includes rebound and high/low speed compression adjustments. More performance oriented valving than stock vehicle. Uses original stock spring. Sold in pairs. 715000511



### FRONT SHOCK PROTECTORS

Offer added protection against tough terrain and weather conditions. Sold in pairs. 715500302

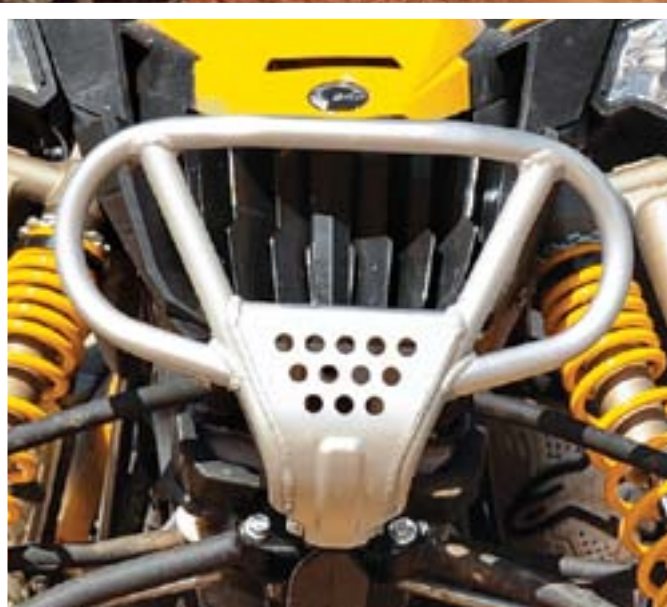

### X PACKAGE FRONT ALUMINIUM BUMPER

Extra-large and lightweight front bumper offers the best protection for all forms of racing. 6063 aluminium construction. Provides superior coverage to the front of your DS 450. Required to install number plate. 715000508



### NUMBER PLATE

Injection molded high gloss finish. To be used with X Package front aluminium bumper (715000508). 715000521 **Black**  
715000522 **Yellow**





**FRONT SPROCKETS**

Hardened steel construction. Changing sprocket ratio will vary vehicle top speed and behaviour. Includes snap ring. For racing applications only.  
**13-tooth (-1)** - 715000519  
**14-tooth (stock)** - 715000591  
**15-tooth (+1)** - 715000518



**REAR SPROCKETS**

Lightweight 7075 T-6 aluminium construction. Changing sprocket ratio will vary vehicle top speed and behaviour. For racing applications only.  
**39-tooth (-3)** - 715000527  
**42-tooth (stock)** - 715000592    **44-tooth (+2)** - 715000515



**SPEEDOMETER**

Digital speedometer. Complete kit with mounting pod. Includes reliable speed sensor built into transmission and extra race functions, e.g. maximum speed, average speed, lap counter, comparative average vs. actual speed and RPM. Easy to install.  
**2009-2011** - 715000512



**REGINA Z-RING CHAIN**

This chain is the best choice for the most severe and demanding applications. Among other characteristics, the ZR chains feature high alloy steel plates and pins, solid bushings and rollers, shot-peening of plates, pins and rollers, performance-enhancing pre-stretched and "Can-Am yellow" outer plates. Stronger than stock chain (32000N). 102 link to match with different sprocket sizes. Includes connecting link.  
 715000523



**FRONT PLASTIC GRILLE**

Adds colour to your vehicle.  
**2009 and prior** - 715000516



# DS 250

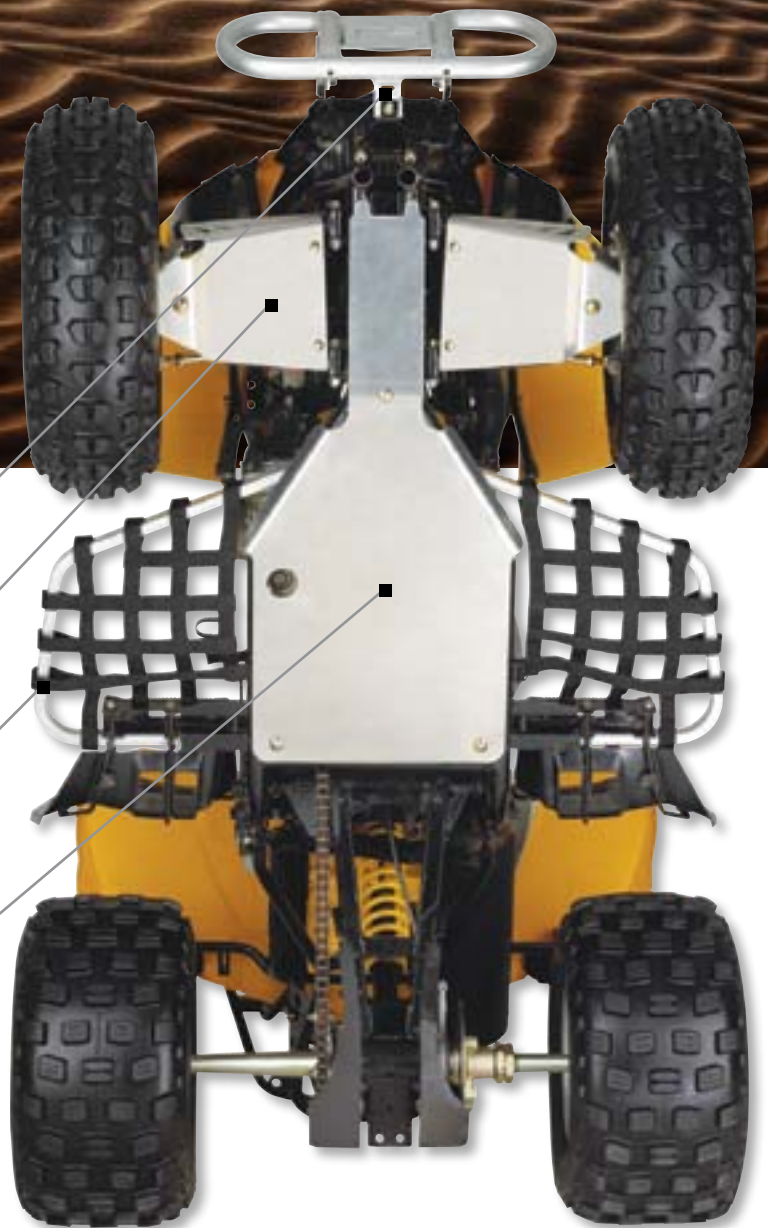

## FRONT BUMPER BRACKET

Adds extra protection to the front of your vehicle.  
715000241

## A-ARM PROTECTORS

These aluminium parts provide maximum A-arm protection.  
703500618

## NERF BARS

Strong lightweight rectangular aluminium tubing provides extra protection for hard riding. Complete with mounting hardware and black webbing. Sold in pairs.  
703500617

## FULL-BODY SKID PLATE

Aluminium full chassis skid plate designed to protect your frame and engine case from rocks and undercarriage damage. Maximum underbody protection when driving your DS on the most rugged terrain.  
703500616



## MIRROR

Stem includes 8 mm [ $\frac{5}{16}$ "] thread.  
Right - S88110RA1000  
Left - S88120RA1000



## REAR RACK

Sturdy steel construction, powder paint finish. Can be used with rear rack bag (715000264).  
715000243 Black



## REAR RACK BAG

100% water-repellent polyester bag. Specially designed to fit on the rear rack (715000243).  
715000264 Black





# APACHE WT SYSTEMS



# THE WIDEST TRACK IN THE INDUSTRY

The 34.6 cm x 2.5 cm [13<sup>5</sup>/<sub>8</sub>" x 1"] rear track profile provides a larger footprint and industry-leading flotation and a 29 cm [11<sup>1</sup>/<sub>2</sub>"] arc-shaped front track reduces vibration and steering effort.

**NOW INCLUDED WITH THE NEW APACHE WT SYSTEMS**

## REAR AND FRONT MOUNTING KITS

A simplified system that reduces installation time. New and improved front mounting kit allows for smoother steering with less effort and reduced stress on the front suspension.

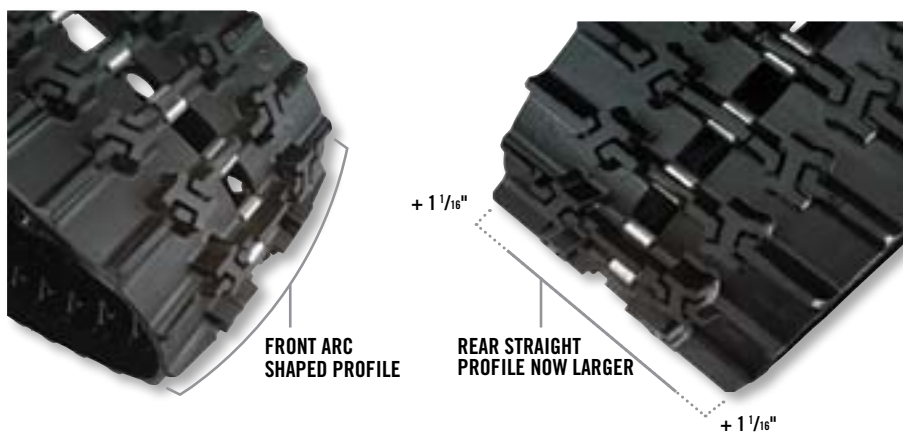

## APACHE WIDE TRACK SYSTEM

(Not illustrated)  
Same great features that have made this a must-have and more. Specially designed for your Can-Am ATV.  
Outlander & Outlander MAX - 715001086

## STUDED APACHE WIDE TRACK SYSTEM

Additional traction providing more control in icy conditions. Factory pre-studded tracks. 114 studs per rear track. 76 studs per front track. 380 studs total.  
Outlander & Outlander MAX - 715001087

**Note:** The Apache WT System is the only track kit available that maintains the Can-Am ATV vehicle warranty.



## CVT PRE-FILTER

Designed to prevent snow intrusion in the CVT and belt slippage when Apache Track System is used in deep snow. Easy to install and remove. Comes standard on Renegade and Outlander 800 2009.  
Renegade & Outlander 500, 650, 800, 2009 and prior - 715000552



## CVT AIR INTAKE

Designed to relocate and maximise height of the CVT air intake to prevent belt slippage in deep snow or muddy conditions. Equipped with integrated CVT pre-filter to also reduce dust and extend CVT and belt life.  
Outlander 500, 650, 800 2008-2009 - 715000970

## PRE-FILTERS

See P.15  
Add extra protection to your engine in harsh riding conditions. Filter blocks particles larger than 0.005".  
715000908 - Air Box Pre-Filter  
715000291 - Air Pre-Filter

**Note:** A pre-filter is necessary to maintain the vehicle warranty when an Apache System is installed.





## INDUSTRY REVOLUTION: 3<sup>RD</sup> DPS MODE

## ONLY AVAILABLE WITH THE APACHE WT SYSTEMS

The 3<sup>rd</sup> DPS™ mode, when installed with the Apache WT system, optimises power steering performance. It is a module for the Dynamic Power Steering maximising steering agility at lower speeds while providing firmer steering at cruising speeds. In addition, it provides a speed correction factor for the speedometer.



# BUILD YOUR Plough SYSTEM IN 3 EASY STEPS BY SELECTING:

1

## THE PUSH FRAME & OPTIONAL FEATURES

Super-duty push tubes withstand the roughest use. Mid-mount carriage provides up to 29 cm [11 ½"] of lift. Push frame fits all blade styles.



**PUSH FRAME**  
Quick-attach not included.  
715001064 Black

**PUSH FRAME FEATURES**



**PUSH FRAME EXTENSION**  
31 cm [12 ¼"] chassis extension for use with Apache Track systems. Increases angle and enables extra blade rotation. Cannot be used with Manual EZ Lift System (703500522) and Remote Angling System (715000260).  
703500603

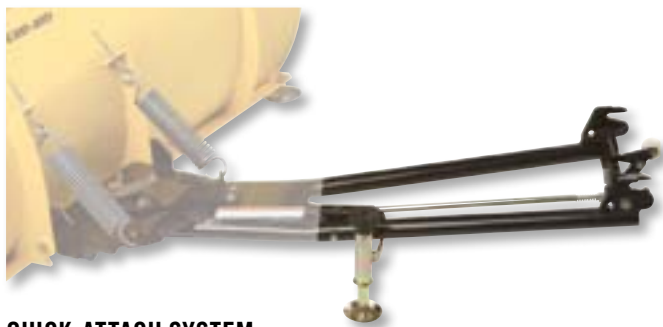

**QUICK-ATTACH SYSTEM**  
Available as an option to upgrade base Push Frame. The plough will be easy to install with this quick-attach system. Durable with a powder-coated rust-resistant finish.  
715000731



**REMOTE ANGLING SYSTEM**  
Increases operator convenience. Swivel system allows the driver to manually pivot the plough blade from the driver's seat. Cannot be used with the Push Frame Extension (703500603).  
715000260



## 2 THE Plough

Straight or One Way State



### STRAIGHT PLOUGH

Super-duty plough blades made from 12-gauge steel. Replaceable wear blades. When angled, 1.5 m [60"] blade clears 1.36 m [53 1/2"] path, 1.37 m [54"] blade clears 1.23 m [48"] path. Blades swivel left or right, 5 positions. Large pin designed for easy blade rotation to eliminate dirt and snow buildup at pivot point. Blade design provides best snow/dirt roll-off at any angle. Yellow-coloured version Can-Am branded.

**1.37 m [54"]**

- 715000647 **Yellow**

- 715000208 **Black**

**1.5 m [60"]**

- 715000648 **Yellow**

- 715000209 **Black**

### ONE WAY STATE PLOUGH

One-way "winged" state plough designed to throw snow higher. Wing end measures 63 cm [25"] high and plough tapers down to 41 cm [16"]. Rubber flap designed to keep snow away from driver. Yellow-coloured version Can-Am branded.

**1.5 m [60"]**

- 715000649 **Yellow**

- 715000207 **Black**

**1.68 m [66"]**

- 715000650 **Yellow**

- 715000253 **Black**

## 3 THE MOUNTING SYSTEM FOR YOUR VEHICLE

Quick release pins attach and detach plough blade and base assembly in minutes. Can be used with or without Quick Attach System (715000731). Simplified installation. No frame drilling required.



(Not illustrated)  
Renegade 2010-2011  
& Outlander X xc 2011 - 715001206

Outlander 2006-2011  
& Renegade 2007-2009 - 715001205

(Not illustrated)  
Outlander 400 2004-2005 - 715000586

Traxter & Quest - 715000258





**REAR TYRE CHAIN**

Improve your traction in mud and snow. Sold in pairs.  
 25 X 10 X 12 - 715000225  
 26 X 10 X 12 - 715500218



**PLOUGH LIGHTS**

Featuring 35W H3 halogen bulbs and a lens design that achieves 110-degree beam spread to provide excellent lighting for ploughing.  
 Outlander - 715000063



**PULLEY KIT**

Pulley kit to be used in conjunction with the winch when using a snow plough. Recommended to increase winch efficiency. To be used with the XT Front Bumper.  
 715000279



**DRIFT CUTTER**

Helps keep snow in the plough. Designed with a rear pivot point. Works with both Straight and One Way State blades.  
 Left: - 715000217  
 Right: - 715000218



**SYNTHETIC WINCH CABLE FOR PLOUGH**

Specially designed for ploughing applications. 2.4 m [8'] section of durable, extra-strong synthetic rope. Stands up to repeated, sharp angle pulls used to lift heavy plough blades. Temporarily replaces your winch rope for plough season to save wear and tear on wire rope.  
 715000540







**RT25 WARN<sup>®</sup> WINCH KIT**

Fully-sealed Warn winch with 2,500 lb. [1,134 kg] of pulling strength. Includes a 0.9 hp motor, 15 m [50'] of 5 mm [<sup>3</sup>/<sub>16</sub>"] wire rope, an ergonomically designed clutch knob, mechanical brake, sealed mini-rocker handlebar switch, a waterproof contactor and a roller fairlead. CE certified. 715000553



**XT15 WARN WINCH KIT**

Lightweight Warn 1,500 lb. [680 kg] winch kit complete with synthetic rope, roller fairlead, mounting plates and hardware. Specifically designed for the Renegade. 715000554



**RT30 WARN WINCH KIT**

Fully-sealed winch capable with 3,000 lb. [1,361 kg] of pulling strength. Includes a 0.9 hp motor, 15 m [50'] of 5 mm [<sup>3</sup>/<sub>16</sub>"] wire rope, an ergonomically designed clutch knob, mechanical brake, hand-held remote and a potted-and-sealed mini-rocker handlebar switch, a waterproof contactor and a roller fairlead. CE certified. 715000528

**XL2500 WINCH KIT FOR TRAXTER/QUEST**

(Not illustrated)  
Complete 2,500 lb. [1,134 kg] winch and mounting kit including a roller fairlead.  
Traxter & Quest - 715000546

**WINCH MOUNTING KIT**

(Not illustrated)  
All Traxter models - 715500108  
All Outlander models - 703500547

**NEW WINCH BRAKE KIT**

(Not illustrated)  
Upgrades standard winch with brake kit. Convenient for use with plough.  
Fits all production Outlander with XL3000 winch  
715001135







**SYNTHETIC WINCH CABLE**

Easier to manipulate than steel cable. Replaces the original cable on any factory installed Warn winch or sold as an accessory by BRP. Kit includes synthetic rope and rock guard sleeve. Always use with roller fairlead (715000011) to prevent premature wear.

**15 m [50'] long. 3,000 lb. [1,361 kg] of strength. - 715000539**

**For XT15 winch only. 12 m [40'] long. 1,500 lb. [680 kg] of strength. - 715000593**



**WINCH ACCESSORIES KIT**

Get the most out of your winch. Double your pulling power, change your pulling direction and keep your winch in proper working order. Includes tree straps, snatch block and shackle. 715000005



**WIRE ROPE REPLACEMENT**

Play it safe. Always carry a replacement wire rope. 15 m [50'] aircraft grade steel wire. 5 mm [3/16"] diameter. 3,000 lb. [1,361 kg] of strength.

**All Warn winches - 715000047**



**WIRED REMOTE CONTROL**

(Not illustrated)  
This kit allows the winch owners to add the hand-held remote to their winch. Works in conjunction with the mini-rocker switch. 715000197

**WIRELESS REMOTE CONTROL**

The system is quick and easy to install, thanks to a wiring harness with an integrated antenna and all necessary mounting hardware. The system allows you to operate your winch from anywhere within a 15 m [50'] radius, increasing your recovery options. All components are weatherproof. Works with all Outlander XT, Traxter/Quest XT MY 2004 and up and BRP accessory winches with a handlebar mounted mini-rocker switch. 715000544

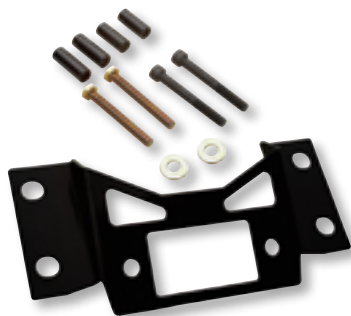

**WINCH FAIRLEAD BRACKET**

Allows for more winch cable clearance when using XT-style bumpers. **Outlander XT, MAX XT - 715000696**



**HOOK WITH SAFETY LATCH & STRAP KIT**

Heavy-duty winch-rope hook with stainless steel snap. Includes a nylon safety strap. 715000069



**ROLLER FAIRLEAD**

Features top, bottom and side rollers for less cable wear and smoother operation from any direction for easier winching. 715000011 **Black**





**RENEGADE TRAILERING COVER**

300-denier solution-dyed, water-repellent polyester construction. Fits with or without mirrors and windshield attachment brackets (windshield must be removed). Key wear areas are reinforced.  
280000316



**DS 450 TRAILERING COVER**

X-attachment system. 300-denier solution-dyed, water-repellent nylon. Key areas are reinforced. Includes sponsor graphics.  
280000346

**OUTLANDER TRAILERING COVER**

(Not illustrated)  
X-attachment system. 300-denier solution-dyed, water-repellent polyester construction. Fits with or without mirrors and windshield. Key areas are reinforced.  
Outlander with Trunk Box - 715000675  
Outlander - 715000682  
Outlander MAX - 715000681



**STORAGE COVER**

For storage use only. Fits with or without windshield and mirrors. Heavy-duty elastic cord around bottom for secure fit.  
100-denier polyester construction  
Outlander MAX - 715000676 Black  
Outlander - 715000677 Black  
Vinyl construction  
Renegade - 715000678 Black  
DS 450 - 280000347 Black  
DS 250 - 715000261 Black





### PREMIUM MODULAR BAG

Multi-configuration four section bag. Constructed of 600-denier, solution-dyed, water-repellent polyester. Semi-rigid thermoformed structure. Heavy-duty water-resistant zipper. Easily converts into a duffle bag.

Outlander 2006-2011 - 280000296 Black



### FRONT BAG

100% water-repellent polyester construction. Designed to fit with or without a rack extension. Integrated map holder. Waterproof zippers.

Outlander 2006-2011 - 715000235 Black

Outlander 2004-2005 - 295100276 Black



### REAR BAG

100% water-repellent polyester construction. Designed to fit with or without a rack extension. Waterproof zippers.

Outlander 2006-2011 - 715000234 Black

Outlander 2004-2005 - 295100277 Black

DS 250 - 715000264 Black



### REAR BAG

Constructed of 600-denier, solution-dyed, water-repellent polyester. Semi-rigid thermoformed structure. Quickly and easily converts into a practical backpack. Heavy-duty water-resistant zipper. Easy to install and remove.

Renegade - 280000295 Black





**GPS MOUNT**

Find your way home. Great for the ATV riding environment. This mount holds steady any GPS under high vibration conditions.  
715000120 **Black**



**MOBILE PHONE MOUNT**

Keep your phone close by when working or riding. The unique design of this mounting system offers easy installation, mobility, strength and versatility.  
715000122 **Black**



**HOOK HOLDER**

An easy way to carry your tools, firearm or bow over any terrain with confidence. Swivels to allow various mounting positions for multiple applications. Allen wrench is included for easy installation to your tubular rack.  
**Single** - 715000042 **Black**    **Double** - 715000043 **Black**



**HAND HELD LIGHT**

High-intensity rubber spotlight comes standard with a one-inch diameter double ball and socket system. Designed to withstand more than 50 g of shock. Can be easily moved from your handlebar, rack or any other location you choose. Plugs into 12V DC outlet.  
715000007 **Black**



**CUP HOLDER**

Mounts easily to handlebars or racks.  
715000121



**BRP CAN-AM VANITY PLATE**

484800455



**TIE-DOWN**

Our 100% polyester ratchet-style tie-down measures 3 m [10'] in length and ensures a safe load with its unique soft loop strap design.  
715000276 **Black**



**MIRROR**

True vision surface. Matte finish. Stem includes 10 mm [3/8"] thread. Bracket (715000190) is required for installation on an Outlander without windshield.  
**Right 8 mm [5/16"]** - 709400407  
**Right 10 mm [3/8"]** - 709400523  
**Left 10 mm [3/8"]** - 709400406

**FLAG**

Make sure everyone knows what you're riding. Perfect for the dunes and new riders. 2.4-m [8'] length. Includes flag mount (715000127).  
715000277 **Yellow**

**FLAG MOUNT**

715000127

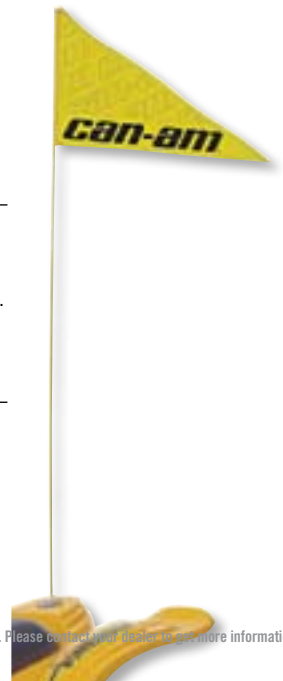



# PRIME TLC FOR YOUR ATV

## Original Equipment Manufacturer and Manufacturer Recommended Products & Kits

You own a Can-Am ATV because you demand the very best from your machine. Take care of your ATV by maintaining it using strictly BRP and Rotax® OEM or 100% Can-Am approved parts and products, and enjoy levels of performance that make every Can-Am ATV ride or functional application a uniquely original experience.



### XPS 4-STROKE OIL CHANGE KIT

Complete maintenance right out of the box: O-Ring, XPS oil, Rotax oil filter and instruction sheet.  
**Summer use** - 703500736  
**All climate use** - 703500735



### CARLISLE<sup>‡</sup> TYRES

The complete collection of Carlisle tyres for Can-Am ATVs under one roof.  
**Front** - 705400431     **Rear** - 705500606



### BRAKE PAD KIT

One-stop replacement brake pad kit designed to replace the parts while keeping your ATV's performance intact.  
 705600349  
 705600350



### UNI FOAM OIL FILTER

Allows maximum airflow while keeping the dirt and dust particles out.  
 5½ oz. 219700340



### UNI FOAM FILTER CLEANER

Uni Filter Cleaner's powerful agents quickly strip away grease and dirt, yet will not damage air filters.  
 14½ oz. 219700341

### YUASA<sup>‡</sup> BATTERIES

Top of the line models from the leading preferred original equipment battery supplier in the U.S.

**18 Amps. Wet (YTX20L-BS)**  
 410301203

**19 Amps. Dry (YB16CL-B)**  
 278001756

**13 Amps. Wet (YTX15L-BS)**  
 710000283

**Dry (YB30CLB)**  
 278001882

**3 Amps. Wet (YT4L-BS)**  
 410301204



### NGK<sup>‡</sup> SPARK PLUGS

BRP dealers carry the full line of premium NGK spark plugs for Can-Am ATVs.  
 707000246

**BECAUSE ONCE YOU RIDE WITH THE BEST, ANYTHING LESS IS MIDDLE OF THE ROAD.**

*See your Can-Am ATV Authorised Dealer for the full line of OEM and manufacturer recommended parts and products.*





Yellow (10)

Green (70)

White (01)

**X RACE JERSEY**

Very light, quick-dry, antibacterial, moisture-wicking fabric. Mesh panels at front, back and armholes for maximum breathability. Extended back for coverage while riding. Non-fading sublimated graphics.

100% Polyester — Sizes: M, L, XL, 2XL  
286193 - White (01), Yellow (10), Green (70)



Back



Yellow (10)

Green (70)

Black (90)

**X RACE PANTS**

Lightweight and extremely breathable pants for riders seeking peak performance, toughness and a competitive edge. Strong nylon outer shell. Overall water-repelling Teflon<sup>®</sup> treatment, and light colours Teflon HT-treated for water and stain resistance. 3/4 length mesh lining. Can-Am sublimated stretch panel on sides. Double- and triple-stitched construction for enhanced durability. Inner knee debossed fullgrain leather for heat and abrasion resistance. Stretch panel at crotch, knee, back and lower back leg for ease of movement. Rubberised elastic waist to hold jersey in place. Ratchet-style waist closure for better adjustment. Straight hem at leg opening for better in-boot comfort.

Shell: 54% Nylon, 41% Polyester, 5% Genuine Leather — Sizes: 30, 32, 34, 36, 38, 40  
286194 - Yellow (10), Green (70), Black (90)



FOR RACE INSPIRED RIDERS WHO WANT TO RIDE LIKE PROS. HIGH PERFORMANCE, MULTIFUNCTIONAL GEAR FEATURING THE BOLD TEAM LOOK THAT HAS PODIUM-FINISH RIDE WRITTEN ALL OVER IT.



White (01)



Charcoal Grey (07)

**X RACE CAP**

Fitted stretch twill cap with all-over pattern. X-Team rubber patch at front.  
98% Cotton, 2% Spandex — Sizes: S/M, L/XL  
286196 - White (01), Charcoal Grey (07)





**MATCHING PRODUCT**



White (01)

Yellow (10)

Black (90)

**X RACE GLOVES**

Designed for coverage and flexibility. Hook-and-loop wrist closure system. Pre-curved design for improved fit. Air mesh panels for ventilation and mobility. Perforated palm for ventilation. Direct injection details on backhand. Silicone fingertip for added grip and control. Double Clarino® layer at palm and thumb for extra durability and comfort. Knuckle gussets for better mobility.  
 Shell: Air Mesh, Spandex, Clarino  
 Sizes: S, M, L, XL, 2XL  
 286195 - White (01), Yellow (10), Black (90)



**CAN-AM ATV XP-2 X RACE HELMET ▶ SEE P.34**

Some models, tyres and accessories depicted may not be available in your country. Please contact your dealer to get more information.





RACE



Matte Black (93)

Black (90)

### TEAM JERSEY

Quick-dry, antibacterial, Microbox moisture-wicking fabric. Mesh at underarms. Non-fading sublimated graphics that match perfectly with Team Riding pants. Drop-tail.  
 100% Polyester  
 Sizes: S, M, L, XL, 2XL  
 286216 - Black (90),  
 Matte Black (93)



Charcoal Grey (07)

Black (90)

### TEAM RIDING PANTS

Ultimate-ride design. Lightweight and durable. Breathable, waterproof nylon shell. 500 denier nylon at seat for extra durability. Double- and triple-stitched construction for added toughness. Sealed critical seams. Zipper ventilation on thigh. 3/4 length mesh lining. Stretch panel at lower back for ease of movement. Water-resistant stretch panel at crotch. Binding hem for reinforcement. Two hip pockets. Quick-release front closure buckle adjustment. Connector attaching pants to Can-Am Riding jacket to prevent jacket from riding up.  
 Shell: 100% Nylon  
 Sizes: 30, 32, 34, 36, 38, 40  
 286138 - Charcoal Grey (07),  
 Black (90)

MATCHING PRODUCT



Charcoal Grey (07)

Black (90)

### TEAM RIDING GLOVES

Hook-and-loop wrist closure system. Spandex construction for good mobility. Pre-curved design for improved fit. Direct-injection patches on back hand. Chamude<sup>®</sup> palm.  
 Shell: Spandex, Chamude  
 Sizes: S, M, L, XL, 2XL  
 286139 - Charcoal Grey (07), Black (90)



CAN-AM ATV XC-1 HOLESHOT HELMET ▶ SEE P.34



RACE



Brown (04) Yellow (10) Black (90)

**CAN-AM RIDING JACKET**

Highly resistant, Teflon HP-treated nylon with RPM waterproof, breathable technology. Double stitch construction throughout. Mesh lining. Sealed critical seams. Shaped sleeves. Double front flap and adjustable wrist, hem and collar. Removable panel at underarm plus additional ventilation at back for maximum airflow. Interior zippered pocket. Two 3-D pockets at chest plus two hip pockets. Can-Am sonic-injection logo at chest; yellow version features X-Team logo. Reflective Can-Am logo at centre back. Connector attaching jacket to Team Riding or Can-Am Cross pants to prevent jacket from riding up.

Shell: 100% Nylon — Sizes: XS, S, M, L, XL, 2XL  
286143 - Brown (04), Yellow (10), Black (90)



**TEAM CAP**

X-Team rubber patch with rubber details on peak. BRP metal adjuster at back. 100% Cotton — One size  
286142 - Charcoal Grey (07), Black (90)



Charcoal Grey (07)



Back

**MUD JACKET**

100% waterproof translucent PVC. Electronically-welded seams. Underarm and rear vent panels. Drawstring hood and hem. Elastic cuffs. Two hand pockets. Sizes: S, M, L, XL, 2XL  
286127 - Clear (00)



**MUD PANTS**

Oversized pants made of 100% waterproof translucent PVC. Electronically-welded seams. Strategic ventilation. Side openings at bottom leg. Sizes: S, M, L, XL, 2XL  
286128 - Clear (00)





White (01)



Turquoise (Aqua) (76)



Back

### LADIES' TEAM JERSEY

Specific fit and design for ladies. Stretch, quick-dry, antibacterial, moisture-wicking fabric for maximum comfort. Fitted cut with non-fading sublimated graphics. Small cuff. V-neck.

94% Polyester, 6% Spandex — Sizes: S, M, L, XL, 2XL

286222 - White (01), Turquoise (Aqua) (76)



White (01)



Charcoal Grey (07)

### LADIES' TEAM PANTS

High-tech feminine design fit for hard-riding. Lightweight and durable. Breathable, waterproof nylon shell. 500 denier nylon at seat for extra durability. Double- and triple-stitched construction for added toughness. Sealed critical seams. Side leg zipper ventilation. <sup>3</sup>/<sub>4</sub> length mesh lining. Water-resistant stretch panel at crotch. Reinforced binding hem with zipper to facilitate exit and entry. 2 hip pockets. Padded, shaped knees.

Shell: 100% Nylon — Sizes: 5-6, 7-8, 9-10, 11-12, 13-14

286148 - White (01), Charcoal Grey (07)



White (01)



Turquoise (Aqua) (76)

### LADIES' STRIPES CAP

Herringbone twill cap. Rubber Can-Am logo with contrasting appliqué stripes. Metal adjuster with BRP logo.

100% Cotton — One size

286150 - White (01), Turquoise (Aqua) (76)



RACE



MATCHING PRODUCT



PRO CROSS XP-R CARBON LIGHT HELMET ▶ SEE P.35



White (01)

Turquoise (Aqua) (76)

**LADIES' TEAM GLOVES**

Pre-curved design for an improved fit. Air mesh panel for maximum ventilation and mobility. Hook-and-loop wrist closure system. Direct injection details on back hand. Silicone fingertips for added grip and control. Double Clarino layer at palm and thumb for extra durability and comfort.

Shell: Air Mesh, Spandex, Clarino

Sizes: S, M, L, XL

286149 - White (01),

Turquoise (Aqua) (76)





Brown (04)

Yellow (10)

Black (90)



Back

### CAN-AM RIDING JACKET

Highly resistant, Teflon HP-treated nylon with RPM waterproof, breathable technology. 500 denier nylon at hem and double stitch construction throughout. Mesh lining. Sealed critical seams. Shaped sleeves. Double front flap and adjustable wrist, hem and collar. Removable panel at underarm plus additional ventilation at back for maximum airflow. Interior zippered pocket. Two 3-D pockets at chest plus two hip pockets. Can-Am sonic-injection logo at chest. Reflective Can-Am logo at centre back. Connector attaching jacket to Team Riding or Can-Am Cross pants to prevent jacket from riding up.

Shell: 100% Nylon — Sizes: XS, S, M, L, XL, 2XL  
286143 - Brown (04), Yellow (10), Black (90)



### CAN-AM CROSS PANTS

Lightweight durable pants Teflon HP-Treated with RPM waterproof and breathable technology. 500 denier waterproof nylon at crotch and seat plus triple seams at crotch. Sealed critical seams. Side leg zipper ventilation. Perfectly positioned flaps to protect all openings from infiltration. Mesh lining. Binding hem at cuff for reinforcement with zipper to facilitate exit and entry. 2 practical cargo pockets with folded flaps. Cell phone pocket inside right cargo pocket. Belt loops. Connector attaching pants to Can-Am Riding Jacket to prevent jacket from riding up.

Shell: 100% Nylon — Sizes: 30, 32, 34, 36, 38, 40  
286126 - Black (90)

**MATCHING PRODUCT**



TRAIL GLOVES ▶ SEE P.26



### TEAM RIDING GLOVES

Hook-and-loop wrist closure system. Spandex construction for good mobility. Pre-curved design for improved fit. Direct-injection patches on back hand. Chamude palm.

Shell: Spandex, Chamude — Sizes: S, M, L, XL, 2XL  
286139 - Charcoal Grey (07)





## ADVENTURE

DESTINATION RIDERS  
LOOK FOR ULTIMATE  
COMFORT FOR DRIVER  
AND PASSENGER.  
WEATHERPROOF  
AND RUGGED TO  
ENHANCE THE RIDE  
TO YOUR FAVOURITE  
SPOT OR SPORT.



Back

**LADIES' CAN-AM RIDING JACKET**

Highly resistant, Teflon HP-treated nylon with RPM waterproof, breathable technology. 500 denier nylon at hem and double stitch construction throughout. Mesh lining. Sealed critical seams. Shaped sleeves. Double front flap and adjustable wrist, hem and collar. Long ventilation at side and underarm, plus additional ventilation at back for maximum airflow. Interior zippered pocket. Can-Am sonic-injection logo at chest and reflective tribal print. Reflective Can-Am logo at centre back. Connector attaching jacket to Team Riding or Can-Am Cross pants to prevent jacket from riding up. Gusset at back armhole for comfort. Brushed polyester at inner collar, pocket and wrist for extra comfort.

Shell: 100% Nylon — Sizes: XS, S, M, L, XL, 2XL  
286201 - Black (90)

**LADIES' CAN-AM CROSS PANTS**

Lightweight durable pants, Teflon HP-treated nylon with RPM waterproof and breathable technology. 500 denier waterproof nylon at crotch and seat. Sealed critical seams. Side leg zipper ventilation.  $\frac{3}{4}$  length mesh lining. Binding hem at cuff for reinforcement with zipper to facilitate exit and entry. Two zippered hip pockets with flaps. Connector attaching pants to Can-Am Riding Jacket to prevent jacket from riding up.

Shell: 100% Nylon  
Sizes: 5-6, 7-8, 9-10, 11-12, 13-14  
286267 - Black (90)





ADVENTURE



Back

**TEAM JERSEY**

Quick-dry, antibacterial, Microbox moisture-wicking fabric. Mesh at underarms. Non-fading sublimated graphics that match perfectly with Team Riding pants. Droptail. 100% Polyester — Sizes: S, M, L, XL, 2XL  
286216 - Matte Black (93)



**TEAM RIDING PANTS**

Ultimate-ride design. Lightweight and durable. Breathable, waterproof nylon shell. 500 denier nylon at seat for extra durability. Double- and triple-stitched construction for added toughness. Sealed critical seams. Zipper ventilation on thigh. 3/4 length mesh lining. Stretch panel at lower back for ease of movement. Water-resistant stretch panel at crotch. Soft inner waist for increased comfort. Binding hem for reinforcement. 2 hip pockets. Quick-release front closure buckle adjustment. Connector attaching pants to Can-Am Riding jacket to prevent jacket from riding up. Shell: 100% Nylon  
Sizes: 30, 32, 34, 36, 38, 40  
286138 - Charcoal Grey (07)



**RAIN JACKET**

Teflon HP-treated nylon. Sealed critical seams. Double front flap to protect against water and air infiltration. Underarm ventilation. Adjustable wrists and hem. Two exterior and one interior zippered pockets. Reflective logos. Shell: 100% Waterproof Ripstop Nylon  
Sizes: S, M, L, XL, 2XL  
440416 - Black (90)



**RAIN PANTS**

Teflon HP-treated nylon. Sealed critical seams. Two zippered hip pockets. Short zipper at calf to facilitate exit and entry. Belt loops. Reflective logos and details. Shell: 100% Waterproof Ripstop Nylon  
Sizes: S, M, L, XL, 2XL  
441416 - Black (90)



ADVENTURE



Back

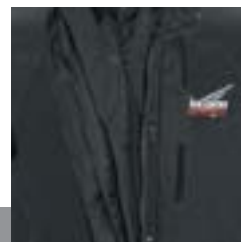

QUADRUPLE FRONT FLAP

## WINTER JACKET

Modern angular design. Robust textured fabric featuring RPM MAX waterproof, windproof and breathable technology. All seams and logos sealed for added protection from water. Quadruple front flap uniquely designed for windproofness while riding. Vents at underarm and back to enhance moisture evacuation during rigorous riding or mild temps. Adjustable fleece-lined chin-cushioned collar, wrists and sides. Soft micro-fleece inner cuffs. Shaped sleeves for unencumbered movement. Powder skirt to keep wind, cold and snow from riding up. MP3, cell phone, cap inner pockets. Easy-access Napoleon pocket. Reflective details.

**Shell:** Nylon — **Insulation:** Primaloft Cresta

**Sizes:** S, M, MT, L, LT, XL, XLT, 2XL

**286253 - Black (90)**

## WINTER HIGHPANTS

RPM MAX waterproof, windproof and breathable technology. All seams and logos sealed for added protection from water. Intelligent combination of materials specifically adapted to warmth, weatherproofing and comfort standards required for off-road winter riding. Lightweight and versatile. Composite insulation for extra warmth at seat and knees. 600 denier nylon seat, knees and inner legs. Pads at knees for durability. Accordion knees and pre-shaped legs for unencumbered movement. Bib style pants with high back and front to keep wind and snow out. Storm gaiter. Reinforced topstitch at back rise. Full-length side zip. Easy-access thigh pocket. Reflective ankle detail.

**Shell:** 100% Nylon — **Insulation:** Primaloft Cresta — **Sizes:** S, M, MT, L, LT, XL, XLT, 2XL

**286254 - Black (90)**



## CAN-AM WINTER RIDING GLOVES

Extra warm nylon, leather palm. Adjustable insulation with removable antibacterial, stay-dry moisture management lining. Visor-wiping cotton terry left thumb for clearing water, snow or fog (also effective on goggles and face). Large gauntlet with adjustable wrist. Reflective details.

**Shell:** Nylon, Leather

**Insulation:** Primaloft One

**Sizes:** S, M, L, XL, 2XL

**286204 - Black (90)**



## CAN-AM WINTER RIDING MITTS

Extra warm nylon mitts with leather palm. Adjustable insulation with removable lining. Antibacterial, stay-dry moisture management lining. Reinforced non-slip palm. Visor wiper. 14 cm [5.5"] gauntlet with adjustable wrist. Reflective details.

**Shell:** 100% Nylon

**Insulation:** Primaloft One

**Sizes:** S, M, L, XL, 2XL

**286257 - Black (90)**





Back



JACKET-IN-POUCH

**BAYOU JACKET**

Waterproof DWR<sup>2</sup>-treated nylon fabric. Wide reflective stripes on shoulder for better visibility. Back ventilation for moisture evacuation. Sealed critical seams. Pre-shaped sleeves. Bellows pocket at left chest. Two Velcro<sup>®</sup> waist pockets with flap to prevent water intrusion. Jacket-in-pouch folds into a back pocket for easy travelling. Cozy collar. Water deflecting double layer storm flaps. Adjustable wrists and hem. Inner pocket. Can-Am print at front and back.  
**Shell: 100% Nylon — Sizes: S, M, L, XL, 2XL**  
 286264 - Charcoal Grey (07)



PANTS-IN-POUCH

**BAYOU PANTS**

Waterproof DWR-treated nylon fabric. Double layer and triple topstitch at seat for durability. Sealed critical seams. Pre-shaped leg. Adjustable suspenders. Storm gaiters at bottom opening. Adjustable waist. Two cargo pockets with flap and gusset at front opening to prevent water intrusion. Gusset at crotch to facilitate movement. Can-Am print at left leg. Elastic at bottom leg to prevent pants from riding up. Pants-in-pouch folds into inner pocket for easy travelling.  
**Shell: 100% Nylon**  
**Sizes: S, M, L, XL, 2XL**  
 286265 - Charcoal Grey (07)



**CAN-AM CANVAS PANTS**

Durable 12 oz polyester-cotton blend canvas. Fabric treated with water repellent, stone-washed for softness and comfort. Durable triple needle stitching and bar tacks at stress points. Double layer at knee. Gusset at crotch to facilitate movement. Higher back waist and shaped legs for better riding comfort. Velcro cargo and back pockets. Can-Am embroidery on back pocket. Belt loops.  
**65% Polyester, 35% Cotton — Sizes: 30, 32, 34, 36, 38, 40**  
 286266 - Warm Grey (15)



**TRAIL GLOVES**

Comfortable and flexible gloves. Leather reinforcements at fingers, palm and backhand for extra durability. Hipora<sup>®</sup> insert at backhand to add water resistance without compromising grip at palm. Pre-curved design for improved fit. Clarino at palm and thumb. Inverted seams at fingers for better comfort.  
**Shell: Air Mesh, Spandex, Clarino**  
**Sizes: S, M, L, XL, 2XL**  
 286268 - Black (90)

**MATCHING PRODUCT**



**CAN-AM ST-3 HELMET ▶ SEE P.36**





RECREATIONAL

APPAREL FOR WORK AND PLAY RIDING THAT DELIVERS GOOD VALUE FOR THE MONEY AND COVERS ALL THE BASICS. RUGGED AND RELIABLE FOR BIG PLAIN FUN!



Back

**MUD JACKET**

**New matte black opaque version.**  
 100% waterproof PVC. Electronically-welded seams. Underarm and rear vent panels. Drawstring hood and hem. Elastic cuffs. Two hand pockets. Can-Am logo at front left chest and upper back vent.

Sizes: S, M, L, XL, 2XL  
 286127 - Matte Black (93)



**MUD PANTS**

**New matte black opaque version.**  
 Oversized pants made of 100% waterproof PVC. Electronically-welded seams. Strategic ventilation. Side openings and Can-Am logo at bottom legs.

Sizes: S, M, L, XL, 2XL  
 286128 - Matte Black (93)





**CAN-AM ZIPPED HOODY**

Full-zip hooded sweatshirt. Ribbed waistband and cuffs. Embossed Can-Am logos on yellow stripe.  
 80% Cotton, 20% Polyester — Sizes: S, M, L, XL, 2XL  
 286209 - Black (90)



**CAN-AM X RACE POLO**

Quick-dry, antibacterial, moisture-wicking fabric. 3-button front placket. Sublimated non-faded Can-Am and sponsor logos. Side slits.  
 100% Polyester — Sizes: S, M, L, XL, 2XL  
 286206 - White (01), Black (90)



Black (90)



Back



**CAN-AM AUTHENTIC CREWNECK**

Crewneck sweatshirt. Ribbed collar, waistband and cuffs. Vintage crackled logo print.  
 80% Cotton, 20% Polyester  
 Sizes: S, M, L, XL, 2XL, 3XL  
 286208 - Charcoal Grey (07)



Navy (89)

Black (90)



Back

**CAN-AM TECHNICIAN SHIRT**

Cotton twill shirt. Chest pockets. X-Team rubber patch at front. Large X-Team embroidery at back. Snap placket. Embroidered sponsor logos on sleeves.  
 100% Cotton — Sizes: S, M, L, XL, 2XL, 3XL  
 286205 - Navy (89), Black (90)





### RENEGADE TEE

Discharged print at front with Can-Am logo on right sleeve.  
100% Cotton — Sizes: M, L, XL, 2XL  
286189 - Black (90)



### CAN-AM BELT

Leather belt with vintage inspired metal Can-Am buckle.  
100% Leather — Sizes: M, L, XL  
286153 - Black (90)



White (01)

Charcoal Grey (07)

Black (90)



### DS TEE

Printed logo at front, X-Team logo on left sleeve and "critter" at back bottom.

100% Cotton — Sizes: M, L, XL, 2XL  
286188 - White (01), Charcoal Grey (07), Black (90)



Ice (38)

Black (90)



Green (70)

Black (90)

### CAN-AM X-TEAM TEE

Can-Am X-Team graffiti print at centre front.  
100% Cotton — Sizes: M, L, XL, 2XL  
286191 - Green (70), Blue (80), Black (90)

### CAN-AM AUTHENTIC TEE

Cool Can-Am vintage crackled logo on chest. Garment enzyme washed for soft and vintage handfeel.  
100% Cotton — Sizes: M, L, XL, 2XL  
286190 - Ice (38), Black (90)





**CAN-AM CLASSIC CAP**

Light ultra-comfortable stretch fabric. 3-D Can-Am embroidery at front. Metal adjuster with BRP logo. 72% Polyester, 23% Rayon, 5% Spandex  
One size  
286210 - Charcoal Grey (07), Black (90)



**CAN-AM TRACK CAP**

Stretch cotton brushed twill hat. Can-Am logo embossed on right front panel. Can-Am rubber logo. 2 contrast stripes on brim. 98% Cotton, 2% Spandex  
Sizes: S/M, L/XL  
286212 - White (01), Green (70), Black (90)



**CAN-AM AUTHENTIC CAP**

Adjustable canvas hat. Vintage logo embroidered at front. Metal adjuster with BRP logo. 100% Cotton — One size  
286211 - Fire Red (06), Grey (09), Black (90)



**CAN-AM COOLMAX TECHNICAL SOCKS**

Below-knee length with varied thicknesses for comfort. Ribbed top. Moisture-wicking Coolmax<sup>2</sup> at foot to keep riders cool and dry. Spandex and nylon for comfort and durability. Elasticised ankle and foot arch for secure comfort and fit. 40% Coolmax, 27% Acrylic, 25% Cotton, 5% Nylon, 3% Lycra — Sizes: S/M, L/XL  
286154 - Black (90)



**CAN-AM SUMMER BEANIE**

Lightweight, texturised knitted beanie with "X" integrated logo and woven Can-Am label appliqué. 95% Cotton, 5% Spandex — One size  
286156 - Black (90)

**TEEN & KIDS**



**TEEN RACE JERSEY**

Made from quick-dry, antibacterial, moisture-wicking fabric. Extended back for riding position. Sublimated print. 100% Polyester — Sizes: 7-8, 10-12, 14-16  
286202 - Yellow (10)



**TEEN TEAM RIDING GLOVES**

Hook-and-loop wrist closure system. Spandex construction for good mobility. Pre-curved design for improved fit. Direct-injection patches on back hand. Chamude palm. Shell: Spandex, Chamude — Sizes: 6-8, 10-12, 14-16  
286203 - Black (90)



**KIDS' CAN-AM TEE**

Can-Am ATV cartoon print at front. 100% Cotton — Sizes: 2, 3-4, 5-6  
286260 - Blue (80)





Charcoal Grey (07)

### LADIES' X-TEAM T-SHIRT

Fitted feminine t-shirt. X-Team logo at chest.  
95% Cotton, 5% Spandex — Sizes: S, M, L, XL  
286262 - White (01), Charcoal Grey (07)



White (01)

### LADIES' AUTHENTIC T-SHIRT

Fitted t-shirt. V-neck with vintage crackled print at front.  
95% Cotton, 5% Spandex — Sizes: S, M, L, XL  
286263 - White (01), Black (90)



Back

### LADIES' X-TEAM POLO

Semi-fitted polo with contrasting placket. X-Team logo printed at chest. Can-Am outline embroidery at back.  
95% Cotton, 5% Spandex — Sizes: S, M, L, XL  
286261 - Charcoal Grey (07)



### LADIES' CAN-AM MICRO-FLEECE HOODIE

Asymmetrical neck opening on a hooded feminine-fit micro-fleece. Contrast cord, hood lining, pocket flaps and logo. Can-Am logo appliqué on left sleeve. Two pockets.  
100% Polyester — Sizes: S, M, L, XL, 2XL  
286200 - Charcoal Grey (07)





**FULL FACE HELMET CASE**

Water-resistant shell biofoam construction. Self-healing nylon zippers. Quick-access spare faceshield storage. External legs for vertical storage. Interior scratch-proof inner surface. Ergonomic soft-touch rubber carrying handle.

One size  
445856 - Black (90)



**CAN-AM PRO GEAR BAG**

Designed and built for consummate riding. Protective helmet compartment, water-tight drained boot compartment, dry-mat and cavernous centre compartment, tool compartment. Inline wheels and pull-handle for maximum portability.

One size  
286214 - Black (90)



**CROSS HELMET CASE**

Water-resistant EXO shell biofoam construction. Self-healing nylon zippers. Quick-access spare faceshield storage. External legs for vertical storage. Interior scratch-proof inner surface. Ergonomic soft-touch rubber carrying handle.

One size  
445857 - Black (90)

**CAN-AM WEEKENDER DUFFLE BAG**

Designed for day trips or extended outings.

One size  
286213 - Black (90)



**CAN-AM X-TEAM GOGGLES BY SMITH<sup>®</sup>**

Hinged strap for excellent fit. Comes with mirrored and clear lenses. Includes tear-off posts. Large flexible frame. Fast absorption technology 3-layer hypoallergenic face foam. Double wide silicone-backed strap. Mask positioning system.

One size  
447310 - White (01), Orange (12)



**PRO CAN-AM GOGGLES WITH QUICK-STRAP BY SMITH**

Same features as Pro Can-Am goggles plus quick-strap.

One size  
445874 - Black (90)



**PRO CAN-AM GOGGLES BY SMITH**

Flexible frame. 2-layer hypoallergenic face foam. Double wide silicone-backed strap. Clear Lexan<sup>®</sup> lens. Optional mask available.

One size  
445873 - Yellow (10), Black (90)





HELMETS

Some models, tyres and accessories depicted may not be available in your country. Please contact your dealer to get more information.





Yellow (10)

### CAN-AM ATV XP-2 X RACE HELMET

Fiberglass/Kevlar® matrix shell: high-tech, lightweight and tough. Fully-adjustable, aero-tuned visor that reduces lift at high speeds. Ventilation system. Moisture-wicking and breathable chin strap, liner and cheek pads. Easily removable and washable liner and cheek pads. Provides maximum visibility, fits all goggles. Strap grip keeps goggle strap in place. Clear coated bold waterslide graphics. Snell M2005 and D.O.T. certified.

Shell: Lightweight Fiberglass/Kevlar — Sizes: XS, S, M, L, XL, 2XL

447407 - Grey (09), Yellow (10) Snell M2005 and D.O.T. certified

447471 - Grey (09), Yellow (10) EC certified



Red (30)

Green (70)

### CAN-AM ATV XC-1 HOLESHOT HELMET

Advanced Polycarbonate Composite shell: lightweight and tough. Fully-adjustable, aero-tuned visor that reduces lift at high speeds. Ventilation system. Moisture-wicking and breathable chin strap, liner and cheek pads. Easily removable and washable liner and cheek pads. Provides maximum visibility, fits all goggles. Strap grip keeps goggle strap in place. Clear coated bold waterslide graphics. Snell M2005 and D.O.T. certified. Two Can-Am stickers included.

Shell: Polycarbonate Composite — Sizes: XS, S, M, L, XL, 2XL

447406 - Yellow (10), Red (30), Green (70) Snell M2005 and D.O.T. certified

447470 - Yellow (10), Red (30), Green (70) EC certified



### CAN-AM ATV XC-1 HELMET

Advanced Polycarbonate Composite Shell: lightweight and tough. Fully-adjustable, aero-tuned visor that reduces lift at high speeds. Ventilation system. Moisture-wicking and breathable chin strap, liner and cheek pads. Easily removable and washable liner and cheek pads. Provides maximum visibility, fits all goggles. Strap grip keeps goggle strap in place. Snell M2005 and D.O.T. certified.

Shell: Polycarbonate Composite — Sizes: XS, S, M, L, XL, 2XL

445960 - Black(90) M2005 and D.O.T. certified

447255 - Black(90) EC certified

## REPLACEMENT PEAKS

(Not illustrated)

One size

### CROSS HELMET (2008)

445909 - Black with graphics (94)

### PRO CROSS HELMET (2008)

445914 - Black with graphics (94)

### CAN-AM ATV CROSS HELMET

445933 - Black (90)

### MECHANITUNE PRO CROSS HELMET

447295 - Silver (08)

### TEAM CROSS HELMET

447296 - Yellow (10), Pink (36)

### CROSS CRITTER HELMET

447297 - Black with graphics (94)

### X RACE PRO CROSS XP-2 HELMET

447408 - Grey (09), Yellow (10)

### HOLESHOT CROSS XC-1 HELMET

447409 - Yellow (10), Red (30), Green (70)

### PRO CROSS XP-R CARBON LIGHT HELMET

447434 - Black (90)



**25% LIGHTER  
THAN ALL OTHER HELMETS  
IN ITS CATEGORY**

## PRO CROSS XP-R CARBON LIGHT HELMET

Our best-of-the-best M.D.C.F. (Multi Directional Carbon Fiber) lightweight helmet with carbon and aramid fiber reinforced shell (weight: +/- 1275 g for "L" size).

EPS foam upper insert between inner fabric and outer shell for optimised user protection.

Integrated rear fin for added stability and aerodynamic performance.

Tool-less multi adjustable wide angle front peak with anti-reflecting sticker just below to deflect glare.

Large flexible nose protector for better protection.

Double D racing buckle, anti-slip goggle strap, pocket for sweat absorbent front pad.

Removable and washable cheek and head pads.

Morpho System Plus - Ergonomic 3D cheek pads available in your size.

Surround comfort sanitised treated interior with Coolmax moisture wicking action.

F.A.S. (Full Air System) with 10 ventilation points and double rear extractor.

Aluminium screws, protective coated parts.

Ergonomic helmet bag.

D.O.T. and ECE 22.05 certified.

Shell: 100% Carbon Fiber Composite — Sizes: XS, S, M, L, XL  
447412 - Black (90)



**CARBON FIBER TEXTURE**



### SWEAT ABSORBENT PADS

One size  
447435 - White (01)



### PRO CROSS XP-R MORPHO KIT CHEEK PADS

Left and right cheek pads included.

Sizes: M, L, XL, 2XL, 3XL  
447436 - Clear (00)



# ST-1 / ST-3\*



Silver (08)

Blue (80)

## CAN-AM ST-1 HYBRID HELMET

Multiple functionalities when fitted with optional one-of-a-kind jaws. Outer shell ventilation features include two ventilation tab kits with anti-fog spray kit. Anti-scratch and retractable sun visor. Moisture-wicking and breathable removable liner and cheek pads. D.O.T. and ECE 22.05 certified.

Shell: Polycarbonate Composite — Sizes: XS, S, S/M, M/L, L, XL  
 447427 - Silver(08), Blue(80), Black(90), D.O.T Certified  
 447467 - Silver(08), Blue(80), Black(90), EC certified



## CAN-AM ST-1 HYBRID FULL FACE JAW

Transforms the ST-1 Hybrid Helmet into a standard full face helmet for extra wind protection.

One size  
 447428 - Silver (08), Blue (80), Black (90)



## CAN-AM ST-1 HYBRID VENTED JAW

Transforms the ST-1 Hybrid Helmet into a jet ventilated full face helmet for enhanced protection with ventilation comfort.

One size  
 447429 - Silver (08), Blue (80), Black (90)



Silver (08)

Black (90)

## CAN-AM ST-3 HELMET\*

Open face helmet. Vent system on top. Double density inner shell. Non-allergenic and breathable internal lining. Clear visor with anti-scratch treatment. D.O.T. approved.

Shell: Polycarbonate Composite — Sizes: XS, S, M, L, XL, 2XL  
 447464 - Silver (08), Black (90)



## CAN-AM ST-1 HYBRID PANE VISOR

Optically-correct shield with hardcoated anti-scratch technology.

One size  
 Short - 447431 - Clear (00)



## CAN-AM ST-1 HARDWARE KIT FOR TOP VENT

Hardware Kit for Top vent replacement.

One size  
 447432 - Clear (00)



## CAN-AM ST-1 HARDWARE KIT FOR VISOR AND JAW

Hardware Kit for Visor and Jaw.

One size  
 447433 - Clear (00)

\*These helmets are not offered in Europe, Middle East & Africa.

Some models, tyres and accessories depicted may not be available in your country. Please contact your dealer to get more information.



# COMPLETELY REDESIGNED NEW GENERATION

OF FULL FACE HELMET INSPIRED BY ORIGINAL MODULAR 2 HELMET

SPACIOUS DESIGN ALLOWS ROOM FOR EYEGLASSES. D.O.T. APPROVED. THE BEST QUALITY / PRICE RATIO ON THE MARKET.

## VISION 180° FULL FACE HELMET\*

Adjustable sunshield  
at the touch of a button.

Integrated sunshield  
for reduced glare.

Clear Vision Technology with  
optically-correct dual lens visor for  
increased 180° peripheral vision.

Exhaust vent for control  
breathing airflow.

Breath deflector system.

Double D ring chin strap.

Shell: Polycarbonate Composite  
Sizes: XS, S, M, L, XL, 2XL, 3XL  
447445 - Grey (09), Red (30), Black (90)



Red (30)

Black (90)



### ELECTRIC VISOR

Sun visor not included.

One size  
445968 - Clear (00)



### REPLACEMENT VISOR

Sun visor not included.

One size  
445967 - Clear (00)



### ABSORBENT MASK

One size  
447473 - White (01)



### SUN VISOR

One size  
445971 - Yellow (10), Smoke (57)



## VISION 180° ELECTRIC FULL FACE HELMET\*

Shell: Polycarbonate Composite  
Sizes: XS, S, M, L, XL, 2XL, 3XL  
447446 - Grey (09), Red (30), Black (90)

\*These helmets are not offered in Europe, Middle East & Africa.

Some models, tyres and accessories depicted may not be available in your country. Please contact your dealer to get more information.



BV<sub>2</sub>S fog-resistant mask system with unparalleled adjustment capabilities to adapt to all faces. Integrated backlight. Dual lens visor featuring enhanced 180° peripheral vision. Adjustable sunshield. Front push-button release. Detachable breathing mask. Quick-release chin strap. Washable interior. D.O.T. approved. Backlight batteries included.



White (01) Red (30) Black (90)

**BV<sub>2</sub>S HELMET\***

Shell: Polycarbonate Composite — Sizes: S, M, L, XL, 2XL, 3XL  
447460 - White (01), Yellow (10), Red (30), Black (90)

**BV<sub>2</sub>S ELECTRIC SE HELMET\***

(Not illustrated)  
447477 - Black (90)



White (01) Yellow (10) Black (90)

**BV<sub>2</sub>S HELMET\***

Polycarbonate Composite — Sizes: S, M, L, XL, 2XL, 3XL  
447404 - White (01), Yellow (10), Red (30), Black (90)



**BV<sub>2</sub>S SE HELMET\***

Polycarbonate Composite — Sizes: S, M, L, XL, 2XL, 3XL  
447468 - Black (90)



**ELECTRIC VISOR**

One size  
447374 - Clear (00)



**REPLACEMENT VISOR**

One size  
445795 - Clear (00)



**SUNSHIELD VISOR**

One size  
445720 - Yellow (10), Orange (12),  
Smoke (57)



**HELMET LIGHTING SYSTEM KIT**

Batteries are not included.  
One size  
447465 - Black (90)



**BREATHING MASK**

One size  
444695 - Yellow (10)



**ABSORBENT MASK**

One size  
447282 - White (01)

\*These helmets are not offered in Europe, Middle East & Africa.

Some models, tyres and accessories depicted may not be available in your country. Please contact your dealer to get more information.





## MODULAR 2 HELMET\*

Built-in Clear Vision Technology with optically-correct dual lens visor for increased peripheral vision and integrated sunshield for reduced glare.

Adjustable sunshield lowers or raises at the touch of a button.

Front push-button release integrated into jaw section facilitates manipulation when wearing gloves.

BREATH EVAC fog-resistant mask system and increased vent diameter control breathing airflow.

Quick-release chin strap.

Spacious design allows room for eyeglasses.

Graphics applied with ink transfer process for high quality finish and increased scratch resistance.

D.O.T. approved.

Shell: Polycarbonate Composite — Sizes: S, M, L, XL, 2XL, 3XL  
445935 - White (01), Grey (09), Yellow (10), Red (30), Black (90)



Grey (09)

Yellow (10)

Red (30)

Black (90)



### REPLACEMENT VISOR

Sun visor not included.  
One size  
445967 - Clear (00)



### ELECTRIC VISOR

Sun visor not included.  
One size  
445968 - Clear (00)



### SUN VISOR

One size  
445971 - Yellow (10), Smoke (57)



### ABSORBENT MASK

One size  
445953 - White (01)



## MODULAR 2 SE HELMET\*

Shell: Polycarbonate Composite  
Sizes: S, M, L, XL, 2XL, 3XL  
447469 - Black (90)

\*These helmets are not offered in Europe, Middle East & Africa.





### BASIC BALACLAVA

No-nonsense balaclava designed for warmth, dryness and comfort. Flatlocked seams prevent skin chafing.

80% Nylon, 20% Spandex

One size

447449 - Black (90)



### MICRO-FLEECE BALACLAVA

Stretchable, antibacterial warming fleece fabric with brushed inner surface. Flatlocked seams prevent skin chafing.

92% Polyester, 8% Spandex

One size

445952 - Black (90)



### MASK SYSTEM BALACLAVA

Mask system helmet-matching balaclava. Seals around mouth and nose, while keeping head and face warm and dry.

60% Polyester, 30% Nylon, 10% Spandex

Sizes: S/M, L/XL

447450 - Black (90)



### MOUNTAIN BALACLAVA

Stretchable, quick-dry fabric with brushed inner surface. Neoprene face guard for effective moisture exchange to promote breathing in extreme cold. Flatlocked seams prevent skin chafing.

80% Nylon, 15% Spandex, 5% Synthetic Rubber

One size

445951 - Black (90)



### TECHNICAL BALACLAVA

Strategically placed mesh for breathability, micro-fleece for warmth. Windproof neck bib. Higher at back of neck for increased motion range.

Flatlocked seams prevent skin chafing.

92% Polyester, 8% Spandex — One size

445950 - Black (90)









# MAINTENANCE







**XPS DOT 4 BRAKE FLUID**

Exceeds DOT 3 and 4 requirements. Unique low-moisture formulation providing maximum protection against vapor lock. Recommended in Ski-Doo® snowmobiles and Can-Am off-road vehicles.  
293600131



**XPS 4-STROKE OIL CHANGE KIT**

Kit includes: 3 quarts of XPS synthetic blend oil, oil filter, o-ring and instruction sheet.  
**For Renegade, Outlander & Commander™**  
Summer use - 703500736 All climate - 703500735



**XP-S SYNTHETIC SUSPENSION GREASE**

Specially designed for Can-Am off-road vehicle suspensions. Offers optimal lubrication at low and high temperature extremes while protecting critical suspension components from dirt and other contaminants.  
400 g - 293550033



**FUEL STABILISER**

Fuel additive to protect against fuel contamination and residue build-up in carburetors and gas lines. Should always be used before storing your Can-Am off-road vehicle. Suitable for all gasoline engines.  
413408601



**XPS 4-STROKE SYNTHETIC OIL - ALL CLIMATE GRADE**

Unlike other ordinary 4-stroke motor oils, XPS all climate grade synthetic 4-stroke oil is specifically engineered to meet the particular lubrication requirements of the Can-Am off-road vehicles equipped with Rotax 4-TEC® 4-stroke engines. Provides easier starting in very cold temperatures.  
946 ml [1 quart] - 293600112 3.785 L [1 US gallon] - 293600115



**XPS 4-STROKE BLEND OIL - SUMMER GRADE**

Synthetic blend 4-stroke engine oil for the Rotax 4-TEC engine. XPS summer grade synthetic blend off-road vehicle engine oil is a high performance oil developed for riders that demand maximum engine performance and protection during all operating conditions.  
946 ml [1 quart] - 293600121  
3.785 L [1 US gallon] - 293600122



**PRE-MIXED ANTIFREEZE/COOLANT**

Pre-mixed ready to top up your coolant level. Blended to perform best in our Rotax engines with anti-corrosive additive.  
219700362



**XP-S LUBE**

A multipurpose lubricant that prevents rust, corrosion and moisture intrusion. Contains active extreme-pressure additives which provide excellent lubricity and antiwear properties. Comes in a spray can that works upside down.  
400 g [14 oz.] - 293600016



**XP-S STORAGE OIL**

This specialty oil is a must when putting your Can-Am off-road vehicle away for extended periods. Specially formulated to protect the engine's internal parts from the hazards of rust and corrosion due to condensation during storage or prolonged periods of non-use.  
350 g - 413711900



**XPS OFF-ROAD VEHICLE HPG-T/A GAS SHOCK OIL**

Recommended for all top quality gas shocks for off-road vehicle including our own Can-Am HPG-T/A nitrogen gas charged shocks. High viscosity index for extreme temperatures encountered in off-road vehicle conditions.  
293600136



**FLEXIBLE SPOUT**

To use your 946 ml [1 quart], 3.785 L [1 US gallon] oil bottles for spill-free pouring. Easy installation.  
414837300



## XPS CLEANING PRODUCTS



### XPS MICROFIBER TOWELS

The latest in high-quality detailing towels. Made up of extremely fine fibres, their soft surfaces have been perfected for drying and polishing motorcycles, boats, cars or any shiny finish. They are so absorbent they hold up to seven times their weight in water. Machine washable means they can be used over and over again.

Packs of 2 219701759



### XPS OFF-ROAD VEHICLE WASH

A biodegradable and non-toxic cleaner that removes mud and dried-on dirt from your off-road vehicle. Whether grimy from the track, the woods or the fields, this cleaner will leave your off-road vehicle sparkling. When used as directed, XPS ATV Wash is safe for all off-road vehicle finishes.

946 ml [32 oz.] 219701702



### XPS FINISHING SPRAY

The final touch to your detailing job. Uses an advanced silicone product. Melon-scented spray quickly treats faded plastics, vinyl, rubber and more to restore their original look. Long lasting, it helps keep mud and dirt from sticking to your vehicle's finish and does not leave streaks or spots. Contains no ozone depleters and no chlorinated solvents.

340 g [12 oz.] 219701704



### XPS BRAKES & PARTS CLEANER

A concentrated blend of solvents with a powerful blasting spray that effectively removes grease, grime, brake fluid and other contaminants from brake components and metal parts without the need for disassembly. Evaporates instantly and completely leaving no residue to hinder performance. Contains no ozone depleters.

397 g [14 oz.] 219701705



### XPS OFF-ROAD VEHICLE CLEANING KIT

Kit includes: XPS off-road vehicle Wash, XPS Finishing Spray and XPS Microfiber Towels.  
219701713

## DECALS



15 cm x 32 cm [6" x 12<sup>3</sup>/<sub>4</sub>"]  
704901484



15 cm x 32 cm [6" x 12<sup>3</sup>/<sub>4</sub>"]  
704901483



30 cm x 10 cm [12" x 4"]  
704901482



Set of 5 cm x 15 cm [2.2" x 6"]  
704901480

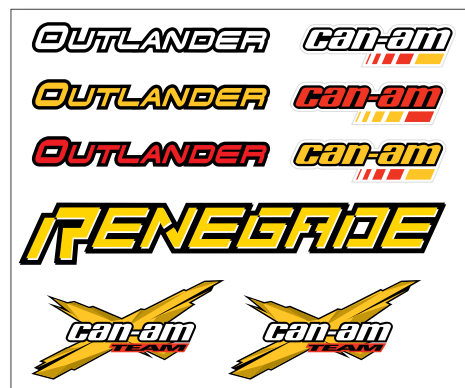

9 per sheet. 60 cm x 20 cm [24" x 8"]  
704901481

# OFFICIAL LICENSED PRODUCTS



### CAN-AM X-TEAM UMBRELLA

147 cm [58"] arc umbrella with fiberglass shaft and black tyre grip handle. CA08A70090



### CAN-AM MULTI-TOOL

High-Sierra® 15-function multi-tool. Includes can and bottle opener, Phillips head screw driver, 3 driver bits (2 – 4 mm), 3 blades (3 – 5 mm), serrated blade, pliers, needle nose pliers, wire cutter and dual-function file. CA08A60090



### CAN-AM FLEECE BLANKET

Anti-pill blanket. 100% polyester. 130 cm x 150 cm [50" x 60"] fleece blanket with carry handles. CA08A80090



### CAN-AM WIRELESS AQUA MOUSE

Wireless mouse with floating vehicle replica. PS/2, USB Port. Compatible with Windows®. CA09A20030

## TRUCK ACCESSORIES



### CAN-AM MUD FLAPS

Keep dirt and mud off trucks, SUVs. Reduce damage from rock chips and other road debris. Fit most trucks and SUVs. Quick and easy installation. Sold in pairs. 4849410086



### CAN-AM X-TEAM HITCH PLUG

Gives trucks, SUVs custom finished look. Keeps dirt, snow and other debris out of receiver. Fits 5 cm [2"] receivers. 4849510086



### CAN-AM X-TEAM REAR WINDOW SKIN

Great looking rear window skin. Provides shade from the sun to help keep interior temps low. Clear view from the inside looking out. Trim to fit almost any vehicle. Non-permanent adhesive for easy removal. 4849110086



### CAN-AM LICENSE PLATE

Made of stainless steel with mirror finish. Raised letters to give 3D look. Thicker and more durable. Universal to fit all vehicles. 4849610008



For additional information or to purchase these items, please contact your nearest BRP dealer.



## SIZING CHART

### HOW TO MEASURE

For best results, have someone else take measurements. Measure body in underwear. Tape must be snug but not tight. If measurements fall between two sizes, order the larger size.

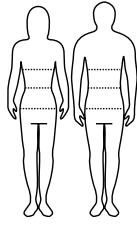

**CHEST/BUST:** Measure under your arms, around the fullest part of your chest.

**WAIST:** Measure around your natural waistline, keeping one finger between the tape and body.

**GLOVES:** Measure palm width.

**HELMET:** Measure around your head at the temple above the eye brow.

### MEN/JACKET

	XS	S	M	MT	L	LT	XL	XLT	2XL	3XL
CHEST	33 - 35	36 - 38	39 - 41	39 - 41	42 - 44	42 - 44	46 - 48	46 - 48	50 - 52	54 - 56
WAIST	28 - 30	30 - 32	33 - 35	33 - 35	36 - 39	36 - 39	41 - 43	41 - 43	45 - 48	50 - 52
ARM LENGTH	31	33	33	34 1/2	34	35 1/2	34	35 1/2	35	35

### MEN/PANTS

	30	32	34	36	38	40
WAIST	30 - 32	32 - 34	34 - 36	36 - 38	38 - 40	40 - 42
HIPS (SEAT)	35 - 37	37 - 39	39 - 41	41 - 42	42 - 44	44 - 46
INSEAM	32	32	32	32	32	33

### LADIES'/JACKET

	XS	S	M	L	XL	2XL
CHEST	32 1/2 - 33 1/2	34 1/2 - 35 1/2	36 1/2 - 38	39 1/2 - 41	43 - 45 1/2	47 - 49 1/2
WAIST	24 1/2 - 25 1/2	26 1/2 - 27 1/2	28 1/2 - 30	31 1/2 - 33	35 - 37	39 - 41
ARM LENGTH	29	30	31	32	32	32

### LADIES'/PANTS

	5-6	7-8	9-10	11-12	13-14
WAIST	26 - 28	28 - 30	30 - 32	32 - 34	34 - 36
HIPS (SEAT)	36 - 38	38 - 40	40 - 42	42 - 44	44 - 46
INSEAM	29	30	30	30	30

### MEN GLOVES (MEASURE PALM WIDTH)

	S	M	L	XL	2XL
CM	7.5	8.5	9.5	10.5	11.5
INCHES	3	3 3/8	3 3/4	4 1/8	4 1/2

### SOCKS

S/M	L/XL
6 - 9	10 - 13

### LADIES' GLOVES (MEASURE PALM WIDTH)

	S	M	L	XL
CM	6.8	7.5	8.3	9
INCHES	2 5/8	3	3 1/4	3 1/2

### HELMETS

	XS	S	M	L	XL	2XL	3XL
HELMET SIZE	6 1/2 - 6 3/4	6 7/8 - 7	7 1/8 - 7 1/4	7 3/8 - 7 1/2	7 5/8 - 7 3/4	7 7/8 - 8	8 1/8 - 8 1/4
HEAD (CM)	53 - 54	55 - 56	57 - 58	59 - 60	61 - 62	63 - 64	65 - 66
HEAD (INCHES)	20 7/8 - 21 1/4	21 5/8 - 22	22 3/8 - 22 3/4	23 1/8 - 23 5/8	24 - 24 3/8	24 3/4 - 25 1/8	25 3/8 - 25 7/8

### KIDS/TEEN

	2	3-4	5-6	7-8	10-12	14-16
CHEST	21	22 - 23	24 - 25	26 - 27	28 1/2 - 30	31 1/2 - 33
WAIST	20	20 1/2 - 21	21 1/2 - 22	22 1/2 - 23	24 - 25	26 - 27
HIP (SEAT)	21	22 - 23	24 - 25	26 - 27	28 1/2 - 30	31 1/2 - 33
ARM LENGTH	15 1/2	17 - 18 1/2	20 - 21 1/2	23 - 24 1/2	28 1/2 - 30	31 1/2 - 33
INSEAM	13 1/2	15 1/2 - 17 1/2	19 1/2 - 21	22 3/4 - 24 1/2	26 1/4 - 28	29 1/2 - 31

## TECHNICAL TERMINOLOGY

### WE KEEP YOU DRY



**Respirative Performance Matrix or RPM coating** exclusive to BRP Riding Gear. Delivers extremely high performance and durability for perfect climate control under even the most extreme conditions. Trademark waterproofness, windproofness and breathability required of BRP Riding Gear shell fabric developed for intensive use and demanding riders.



Same great RPM coating PLUS total seam and logo sealing. Also, added direct venting in strategic jacket areas for more efficient moisture management during intense activity.

### TEFLON

Teflon provides an invisible barrier around fabric fibers to repel water and stains. In addition to retaining its water shedding properties longer than standard Teflon, Teflon HT and HP are also even more resistant to soiling and staining without altering the fabric's colour, appearance, structure, texture and breathability. Teflon HT, good up to 20 washes and Teflon HP up to 30 washes compared to manufactured coatings washable only 1 to 5 times.

### HIPORA

Windproof, breathable and waterproof membrane that features unique polyurethane coating technology and delivers excellent moisture management.

### DWR

DWR stands for Durable Water Repellency. This treatment helps prevent the outer fabric surface from absorbing water, keeping the outerwear both light and comfortable.

### SEAM SEALING

Seams and embroidery can act as tiny entry points through which wind and water can infiltrate. That is why jackets and pants with RPM are critical seam and logo sealed. And Riding Gear with RPM Max are 100% seam and logo sealed for an even more comprehensive barrier from all the elements. The proprietary tape is also waterproof and breathable to fully seal the deal for complete performance.

### WE KEEP YOU WARM



**CRESTA BY PRIMALOFT** Primaloft Cresta offers warmth without weight and extra bulk. It is designed to keep you warm and comfortable throughout the day.



**PRIMALOFT ONE** Warmer wet or dry than any other synthetic insulation. The ultimate down-like microfiber insulation. Quick drying, soft, and breathable. Primaloft One is lightweight, compressible and thermally efficient.



### WHAT CODE REPRESENTS YOUR SIZE?

1. Find your size
2. The corresponding code is **THE CODE** you use to complete the part number on your order.

Example: 440 227\_90  
Size: M = code 06  
Therefore 440 227 **0690**

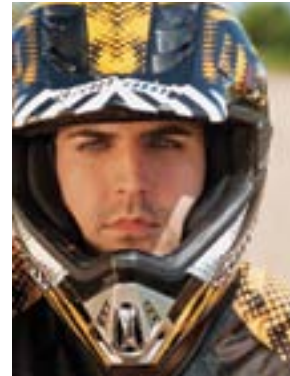

SIZE	CODE
One Size	00
XS	02
S	04
M	06
MT	07
L	09
LT	10
XL	12
XLT	13
2XL	14
3XL	16
S/M	72
L/XL	73
2	21
3-4	79
6-8	48
10-12	49
14-16	50
30	37
32	38
34	39
36	40
38	41
40	42
5-6	52
7-8	54
9-10	55
11-12	56
13-14	80





Some models, tyres and accessories depicted may not be available in your country. Please contact your dealer to get more information.



# THE WORLD IS OUR PLAYGROUND

Nothing is more valuable than your playtime. That is why BRP is dedicated to continually finding new and better ways to help you enjoy your favourite power sports. From snow to water to both on- and off-road fun, our passion for adventure fuels the innovations that result in the ultimate power sports experience for our customers. We value



the land and water we play on and are committed to protecting it. Our desire to thrill is paired with an emphasis on rider responsibility, placing personal safety above all else. So that each outing can be the most enjoyable, memorable and thrilling experience possible. Because your free time should always be your best time.

[www.brp.com](http://www.brp.com)



SKI-DOO® LYNX® SEA-DOO® EVINRUDE® JOHNSON® ROTAX® CAN-AM®

